

DREO

Tower Fan

USER MANUAL

www.dreo.com

DR-HTF005

Looking for help?

Contact us to get expert support.



support@dreo.com



[\(888\) 520-3736](tel:(888)520-3736)



www.dreo.com

Mon - Fri, 9:00 am-5:00 pm PST/PDT

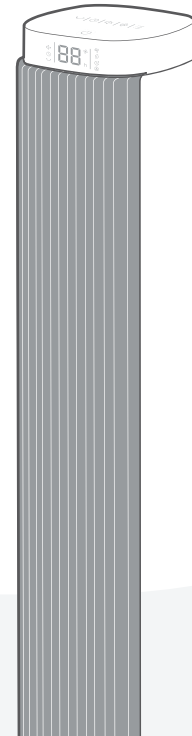

//

Thanks for Choosing DREO!

Your support means the world to us. We hope you enjoy our product as much as we did creating it.

EXTEND YOUR WARRANTY FOR FREE

Scan or visit dreocom.com/warranty to extend your warranty for free by registering your product. If you have any product issues, we always stand ready to help.



✉ support@dreocom.com

🌐 www.dreocom.com

☎ (888) 520-3736

Mon - Fri, 9:00 am-5:00 pm PST/PDT



CONTENTS

1

**IMPORTANT
SAFETY
INSTRUCTIONS**

1-2

2

**ASSEMBLING
YOUR TOWER
FAN**

3-5

3

**KNOWING YOUR
TOWER FAN**

6-7

4

**USING YOUR
TOWER FAN**

8-10

5

**CLEANING
AND
MAINTENANCE**

11

6

**TROUBLE-
SHOOTING**

12

7

**DREO
CUSTOMER
CARE**

13

IMPORTANT SAFETY INSTRUCTIONS



READ ALL CAUTIONARY MARKINGS ON THE APPLIANCE AND SAFETY INSTRUCTIONS IN THE USER MANUAL BEFORE USE.

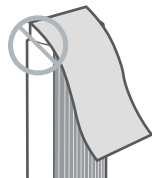

Do not cover the air inlet and outlet while in operation.



Do not use the fan near flammables and combustibles.

General Safety

1. Children shall not play with the appliance. Cleaning and maintenance shall not be performed by children without supervision.
2. Use the appliance as described in the user manual only. Any other use not recommended in the user manual may cause fire, electrical shock, or personal injury.
3. This appliance can be used by children aged above 8 years and persons with reduced physical, sensory or mental capabilities or lack of experience and knowledge if they have been given supervision or instruction concerning use of this appliance in a safe way and understand the hazards involved.

Operation Safety

1. Place the appliance on a flat, dry surface before use.
2. **Do not** immerse in water and any other liquids.
3. **Do not** use the appliance until the base is installed.
4. **Do not** insert your fingers, pencil and any other objects into the grilles while in operation.
5. **Do not** dismantle, repair, or modify. All servicing should be performed by qualified personnel.

Electricity Safety

1. Make sure that the voltage of your electricity supply is the same as that indicated on the appliance.
2. Always unplug before cleaning or leaving the appliance unused for a long period of time. Keep your hands dry when plugging/unplugging.
3. Do not operate any fan with a damaged cord or plug. Discard fan or return to an authorized service facility for examination and/or repair.
4. Do not run cord under carpeting. Do not cover cord with throw rugs, runners, or similar coverings. Do not route cord under furniture or appliances. Arrange cord away from traffic area and where it will not be tripped over.
5. **WARNING:** To reduce the risk of fire or electric shock, do not use this tower fan with any solid-state speed control device.
6. Use 24V/1A power adapter only. Turn off the appliance before plugging.

FOR HOUSEHOLD USE ONLY READ AND SAVE THESE INSTRUCTIONS

Gentle Reminder:



Check the appliance regularly and refer to TROUBLESHOOTING or contact our customer support if it shows any of the following signs:

- Power cord or plug is damaged.
- Loud noise, unusual smell or excessive heat.

Specifications

Model	DR-HTF005
Power Supply	24V \approx 1A
Rated Power	24W
Power Adapter	Input: 100-240V ~50/60Hz Output: 24V \approx 1A
Remote Control Battery	CR2025 3V

ASSEMBLING YOUR TOWER FAN

2

Assembly Instructions

When using the appliance for the first time, remove the wraps and attach the parts by following the steps below.

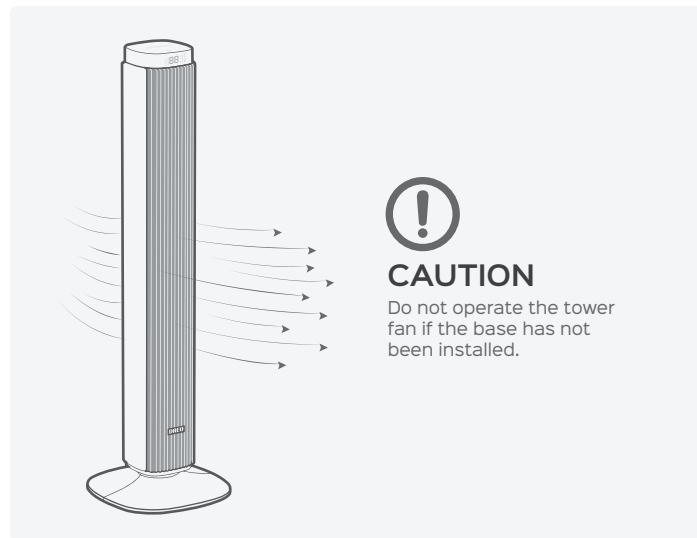
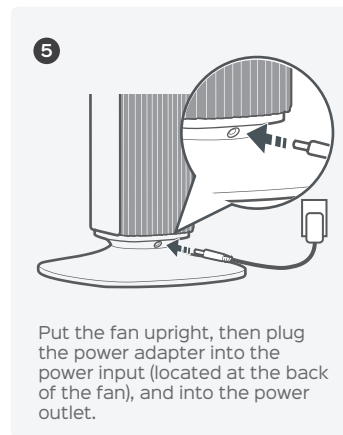
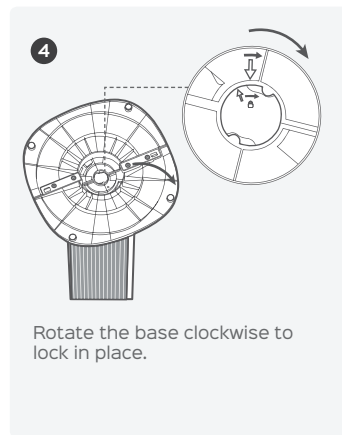
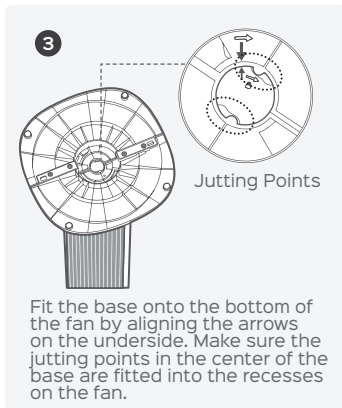
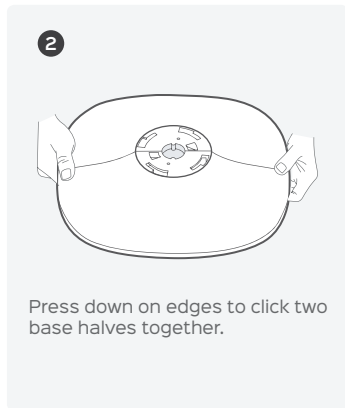
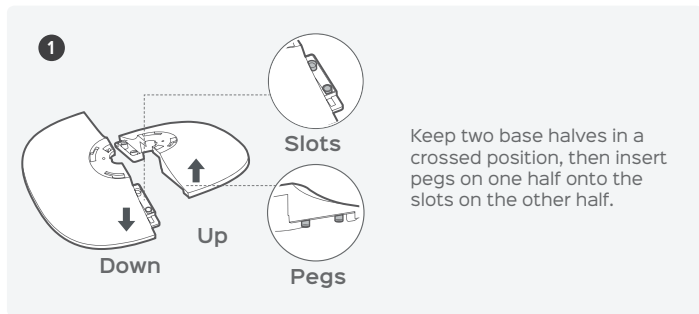

Package Contents

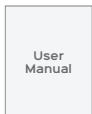
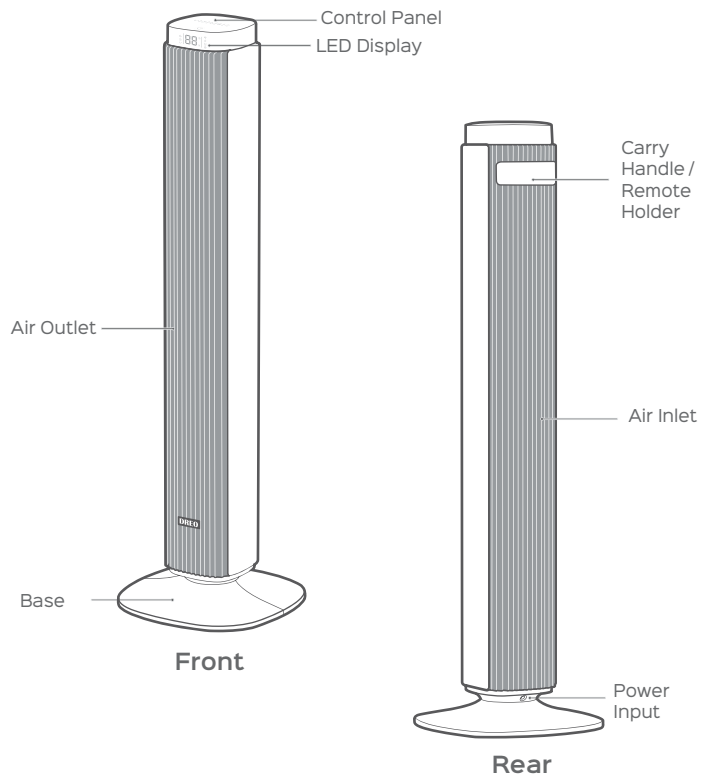

User Manual



Quick Start Guide



Remote Control
(Battery Included)



Power Adapter

3

KNOWING YOUR TOWER FAN

Control Panel



Oscillation Button

Adjust airflow direction



Timer Button

Select to set a timer (0-12h)



Mute Button

Turn on/off button sounds



Fan Speed Button

Adjust fan speed (1-9 levels)



Mode Button

Switch between Normal/Natural/Sleep/Auto Mode



Power Button

Turn power on/off

LED Display

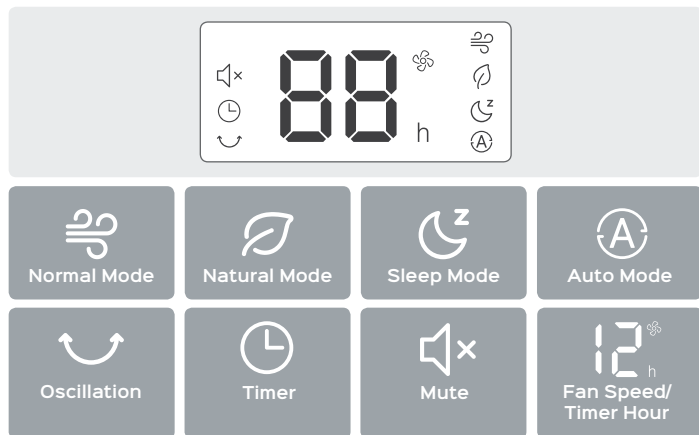

NOTE:

- Display will turn off after 1 minute (after 5 seconds in sleep mode).
- Wake the display up with any button.
- Display will not turn off when the auto on timer is enabled.

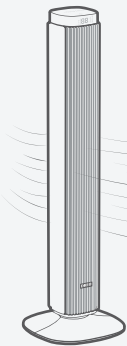

Getting the Most out of Your Tower Fan

1. It's not an air conditioner.
2. Remove any tall obstacles that might block the airflow from the fan.
3. Combine with your AC unit to get cooler air throughout the room.
4. Position the tower fan closer to you to get more direct airflow.
5. Place a bucket of ice in front of the fan for an extra cooling boost.

USING YOUR TOWER FAN

General Operations

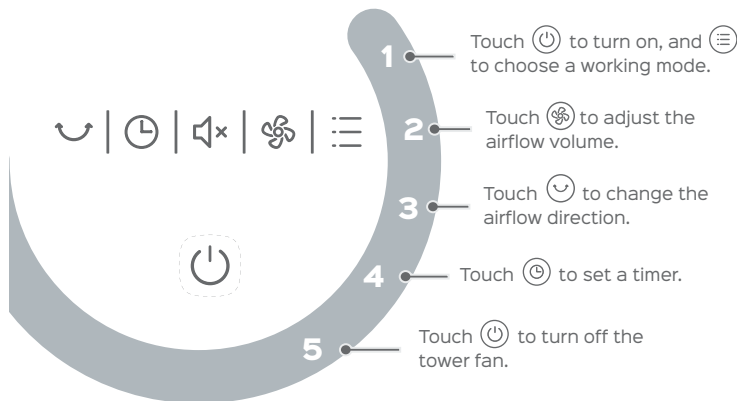



Working Modes

Sleep Mode (Mute Auto On)

Fan speed decreases every 30 minutes. Speed decreases by two levels at most and will remain constant if at level 3, 2 or 1:
 For level 9: 9→8→7
 For level 8: 8→7→6
 For level 7: 7→6→5
 For level 6: 6→5→4
 For level 5: 5→4→3
 For level 4: 4→3
 For level 3: 3
 For level 2: 2
 For level 1: 1

 **Auto Mode**
 Fan speed adapts to the ambient temperature.

 **Normal Mode**
 Fan runs at the constant speed.

 **Natural Mode**
 Fan runs at alternating speeds.

Additional Features



Timer

When the fan is ON/OFF, touch the timer button  repeatedly to set a timer from 1 to 12 hours. When the timer ends, the fan will stop/start running automatically. To cancel, set the time to 0 hour.

Note: When the auto off timer is enabled, display will return to fan speed after 3 seconds.



Mute

Touch the mute button  to turn on or off the button sounds.



Memory

If the fan is turned OFF or disconnected from power, it will operate under the previous settings (except the timer setting) when it is turned ON again.

Remote Control

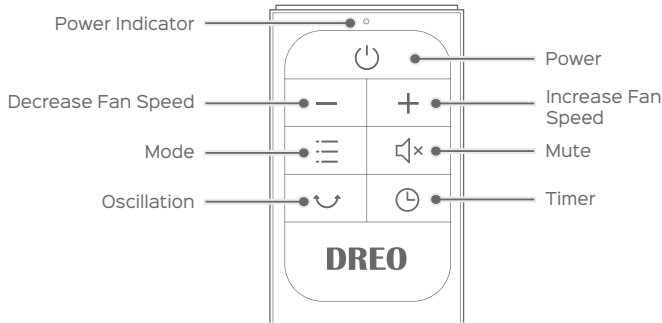

Battery Replacement

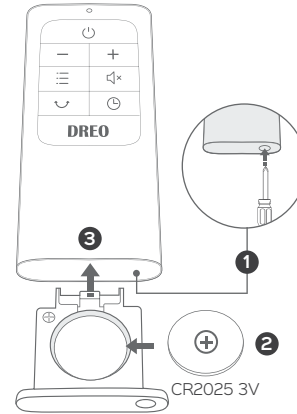

- 1 Press the locking button to pop out the battery holder.
- 2 Replace with the same battery type with the (+) side facing up.
- 3 Push in the holder until securely locked into place.

Note: If the indicator on the remote control doesn't turn on any more, please consider replacing the battery.



WARNING

Chemical Burn Hazard. Keep batteries away from children.

This product contains a lithium button/coin cell battery. If a new or used lithium button/coin cell battery is swallowed or enters the body, it can cause severe internal burns and can lead to death in as little as 2 hours. Always completely secure the battery compartment. If the battery compartment does not close securely, stop using the product, remove the battery, and keep it away from children. If you think batteries might have been swallowed or placed inside any part of the body, seek immediate medical attention.

The batteries must be disposed of properly, including keeping them away from children. Even used cells may cause injury.

CLEANING AND MAINTENANCE

5

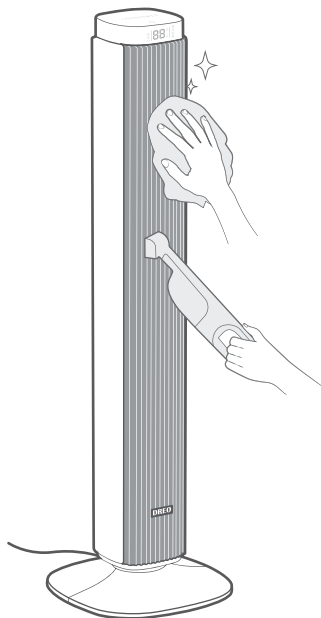

Outer Surface

Gently wipe off the dust with a soft, dry cloth.

Grilles & Blades

Remove the dust using a vacuum or air duster.

Base

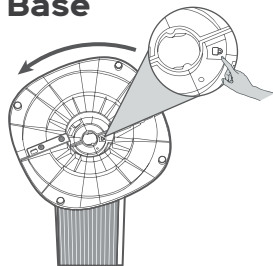

Press on the lock sign here and rotate counterclockwise to release the base, then disassemble the base in the reverse order of assembly.

CAUTION



1. Always unplug the fan before any cleaning or maintenance to avoid the risk of fire, electric shock, or injury to persons.
2. Do not immerse in water or get water inside the motor housing.
3. Do not use any chemical agents when cleaning the fan.
4. Store in a cool, dry place and cover it to protect from dust.

TROUBLESHOOTING

6

My fan won't turn on!

1. Make sure that the cord is connected to a powered outlet and the mains voltage corresponds with the voltage indicated on the fan.
2. Check if the power adapter is securely inserted into the power outlet and the tower fan.

My fan is shaky and wobbling!

1. Place the fan on a flat, level surface.
2. Incorrect installation might also cause shakiness. Please refer to the assembly instructions in [page 3-4](#).

My fan is making vibration and noise!

1. Place the fan on a flat, level surface.
2. Be sure not to insert anything into the air inlet and outlet.

If your problem is not listed or still persists, please contact our Customer Support ([see page 13](#)).

DREO CUSTOMER CARE



Default 12-Month Warranty

This appliance is covered by Dreo warranty for 12 months from the date of its original purchase.

Extend Your Warranty

Extend your warranty by registering your new appliance on our website <https://dreo.com/warranty>.

The warranty will not apply in cases of:

1. Accident, misuse, or repairs performed by unauthorized personnel.
2. Any unit that has been tampered with or used for commercial purposes.
3. Normal wear and tear of wearable parts.
4. Use of force, damage caused by external influences.
5. Damage caused by non-observance of the User Manual, e.g. connection to an unsuitable mains supply or noncompliance with the instructions.
6. Partially or completely dismantled appliances.
7. Defects caused by or resulting from damages from shipping or from repairs, service, or alteration to the product or any of its parts that have been performed by a repair person not authorized by Dreo.

We can only provide after-sales service for products that are sold by Dreo or Dreo authorized retailers and distributors. If you have purchased the appliance from a different place, please contact your seller for return and warranty issues.

 (888) 520-3736  support@dreo.com  www.dreo.com
Mon - Fri, 9:00 am-5:00 pm PST/PDT

FCC Statement

This device complies with Part 15 of the FCC Rules.

This equipment has been tested and found to comply with the limits for a Consumer ISM equipment, pursuant to Part 15 of the FCC Rules. These limits are designed to provide reasonable protection against harmful interference in a residential installation. This equipment generates, uses and can radiate radio frequency energy and, if not installed and used in accordance with the instructions, may cause harmful interference to radio communications. However, there is no guarantee that interference will not occur in a particular installation.

Please note that changes or modifications of this product is not expressly approved by the party responsible for compliance could void the user's authority to operate the equipment.

If this equipment does cause harmful interference to radio or television reception, which can be determined by turning the equipment off and on, the user is encouraged to try to correct the interference by one or more of the following measures:

-Reorient or relocate the receiving antenna.

-Increase the separation between the equipment and receiver.

-Connect the equipment into an outlet on a circuit different from that to which the receiver is connected.

-Consult the dealer or an experienced radio/TV technician for help.

Rev_2,2_EN

 www.dreo.com

 Shenzhen Hesung Innovation
Technology Co., LTD

 26F, Bldg A7, Creative City, Shenzhen, China **MADE IN CHINA**



Intertek
5018396