

OPERATION

Using the Washer

WARNING

- To reduce the risk of fire, electric shock, or injury to persons, read the SAFETY INSTRUCTIONS before operating this appliance.

1 Sort laundry and load the washer.

Sort laundry by fabric type, soil level, color and load size, as needed. Open the lid (door) and load items into the washer.

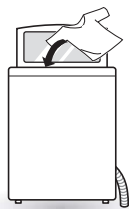

2 Add cleaning products.

Add the proper amount of HE (High-Efficiency) detergent to the detergent dispenser. If desired, add bleach or fabric softener to the appropriate dispensers.

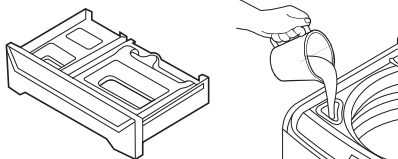

3 Turn on the washer.

Press the **Power** button to turn on the washer. The lights above the cycle buttons will illuminate and a chime will sound.

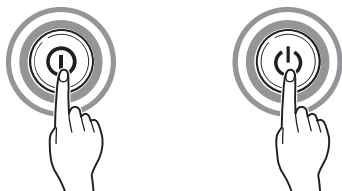

4 Select a cycle.

Turn the cycle selector knob or press the cycle buttons repeatedly until the desired cycle is selected. The preset wash temperature, spin speed, soil level and option settings for that cycle are shown.

- Pressing the **Start/Pause** button without selecting a cycle will cause the Normal cycle to begin immediately.

5 Adjust settings.

Default settings for the selected cycle can now be changed, if desired, using the cycle modifier and option buttons.

NOTE

- Not all modifiers and options are available on all cycles. A different chime sounds and the LED does not light up if the selection is not allowed.

6 Begin cycle.

Press the **Start/Pause** button to begin the cycle. The lid (door) locks, and the washer agitates briefly without water to measure the weight of the load.



7 Additional garments can be added to the tub while the Add Garment light is on.

The **Add Garment** light illuminates near the beginning of the wash cycle to indicate when it is safe to add items to the load. Press the **Start/Pause** button to pause the cycle and add garments to the load. Press the **Start/Pause** button to resume the cycle.

NOTE

- Adding items after the Add Garment light turns off may result in poor wash performance.

8 End of cycle.

When the cycle is finished, a melody sounds. Immediately remove the clothing from the washer to reduce wrinkling.

- If the washer includes lint filters, remember to check them after every 2 to 3 loads.

Sorting Laundry

CAUTION

- The washer can be fully loaded, but the tub should not be tightly packed with items. The lid (door) of the washer should close easily.
- Use the Bedding cycle for buoyant or nonabsorbent items such as pillows or comforters. Failure to follow this caution can result in leakage.
- Clothing or articles that are waterproof or water resistant must be washed in the Waterproof cycle only. (e.g. water resistant clothing, mattress covers, outdoor clothes, plastic mats, etc.) Otherwise, it may result in personal injury or damage to the washer, clothes, walls, floor, and surrounding objects due to abnormal vibration.

Grouping Similar Items

For the best washing results, and to reduce the possibility of damage to clothing, care should be taken to sort the clothing into loads that are made up of similar items.

Mixing different fabric types and/or soil levels can result in poor wash performance, color transfer, discoloration, fabric damage or linting. Fabrics should be sorted into groups as described below.

Colors

Sort articles by color. Wash dark clothes together in a separate load from light colors or whites. Mixing dark clothes with light clothes can result in dye transfer or discoloration of the lighter clothes.

Soil Level

Wash heavily soiled clothing together. Washing lightly soiled clothing in the same load with heavily soiled clothing could result in poor wash performance for the lightly soiled clothing.

Fabric Type

Delicate articles should not be mixed with heavy or sturdy fabric types. Washing heavy fabrics in a delicate load can result in poor wash performance for the heavy fabrics and possible damage to the delicates.

Lint Type

Some fabrics attract and bind lint to them while others give off lint in the laundry process. Avoid mixing these lint collectors and lint producers in the same load. Mixing these fabrics will result in pilling and linting on the lint collectors. (For example, lint collector—knit sweater; lint producer—terry cloth towels.)









Sort Laundry

By Colors	By Soil	By Fabric	By Lint
White	Heavy	Delicates	Lint Producer
Lights	Normal	Easy Care	Lint Collector
Darks	Light	Sturdy	

ENGLISH

Fabric Care Labels

Many articles of clothing include a fabric care label. Using the chart below, adjust the cycle and option selections to care for your clothing according to the manufacturer's recommendations.

Category	Label	Directions
Washing		Hand wash
		Machine wash, Normal cycle
		Perm Press/Wrinkle Resistant setting (which has a cool down or cold spray before the slower spin)
		Gentle/Delicate setting (slow agitation and/or reduced wash time)
		Do not wash
		Do not wring
Water Temperature	...	Hot
	..	Warm
	.	Cold/Cool
Bleach Symbols		Any bleach (when needed)
		Only non-chlorine bleach (when needed)
		Do not bleach

Loading the Washer

- Check and empty pockets. Paper clips, coins, matches, etc. can damage clothing and the washer.
- Close zippers and hooks, and tie drawstrings to prevent snagging or tangling of clothes.
- Pretreat heavily stained areas for best results.
- Combine large and small items in a load. Load large items first. Large items should not be more than half of total load.
- Wash thick, bulky items individually. Heavy blankets, comforters, bedspreads, or pet beds can get tangled or cause an unbalanced load if combined with other items.
- The washer can be fully loaded, but the tub should not be tightly packed with items. The lid (door) of the washer must close easily.

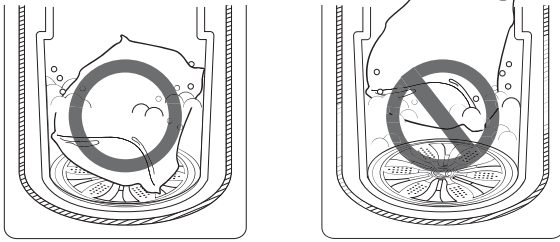

- Do not wash single small items. Add 1-2 similar items to the load to prevent an out-of-balance load.
- Clothing or articles that are waterproof or water resistant must be washed in the Waterproof cycle only. (e.g. water resistant clothing, mattress covers, outdoor clothes, plastic mats, etc.) Otherwise, it may result in personal injury or damage to the washer, clothes, walls, floor, and surrounding objects due to abnormal vibration.
- Wash small, light items in a mesh bag. Small items can get caught in the impeller at the bottom of the tub, and brassiere hooks can damage other items or the tub.
- Brush off heavy soil, dust, and hair from items before washing. Excess dirt or sand can abrade other fabrics and lead to poor wash performance.
- The washer will not fill or operate with the lid (door) open.

- Use the Bedding cycle for large or bulky items such as poly-filled jackets, comforters, pillows, etc. These items may not be as absorbent as other laundry items and should be sorted into a separate wash load for optimal results.
- Bulky items should be placed as far down in the tub as possible for optimal results. Always place buoyant items at the bottom of the tub. The washer will automatically detect the load size. Because of the high efficiency wash system, the water level may not completely cover the load.
- Do not overload the tub. Clothes should fit loosely in the tub under the maximum fill line. Loading clothes over the fill line may result in damage to clothing and the washer.
 - Load clothes loosely, and do not overfill the tub. Clothes need room to circulate in order to get clean.
 - Do not press down on items while stacking them in the tub.

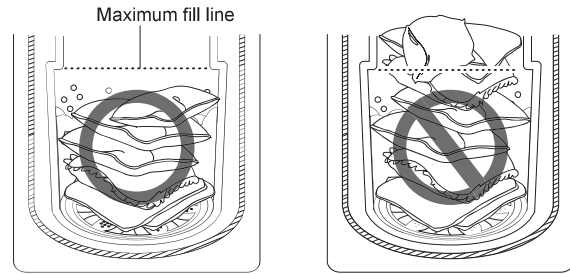

- For best performance, load clothes as shown.

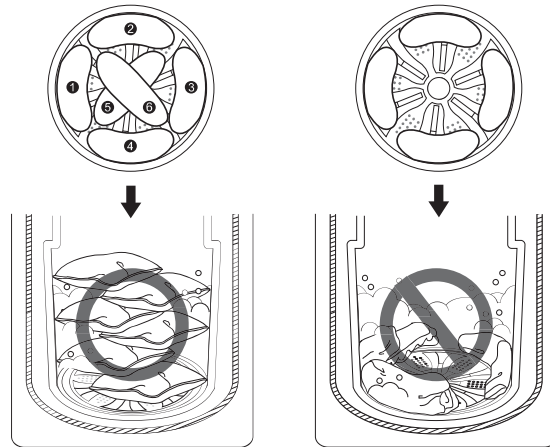

Adding Cleaning Products

About the Dispensers

The automatic dispenser consists of two compartments which hold:

- Liquid fabric softener
- Liquid or powdered detergent for main wash

Using the Detergent and Softener Dispensers

To add detergent and fabric softener to the automatic dispenser:

- 1 **Open the dispenser drawer.**
- 2 **Load the laundry products into the appropriate compartments.**

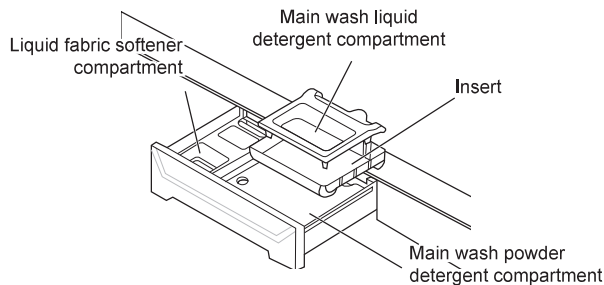

- 3 **Close the drawer completely before starting the cycle.**
 - Be careful not to catch a hand in the drawer while closing.

! CAUTION

- Do not place or store laundry products, such as detergent, bleach, or liquid fabric softener, on top of your appliance. Wipe up any spills immediately. These products can damage the appliance's finish and controls.

NOTE

- It is normal for a small amount of water to remain in the dispenser compartments at the end of the cycle.

Main Wash Detergent Compartment

This compartment holds laundry detergent for the main wash cycle. Either powdered or liquid detergent may be used in this compartment. The detergent is added to the load at the beginning of the cycle. Always use HE (High-Efficiency) detergent with your washer.

NOTE

- Never exceed the manufacturer's recommendations when adding detergent. Using too much detergent can result in detergent buildup in clothing and the washer.
- When using liquid detergent, make sure the liquid detergent compartment and insert are in place. Do not exceed the maximum fill line.
- When using powdered detergent, remove the insert and liquid detergent compartment from the dispenser. Powdered detergent will not dispense with the liquid detergent compartment and insert in place.
- If you use a detergent that does not dissolve easily or a detergent with high viscosity, it will leave a residue and clog the dispenser.

Fabric Softener Compartment

This compartment holds liquid fabric softener, which is automatically dispensed during the final rinse cycle.

NOTE

- Do not exceed the manufacturer's recommendations when adding softener. Using too much fabric softener can result in buildup in clothing and the washer. Either powdered or liquid fabric softener may be used.
- Follow the manufacturer's recommendations when adding fabric softener. Do not exceed the maximum fill line. Using too much fabric softener may stain clothes.
- Dilute concentrated fabric softeners with warm water.
- Never pour fabric softener directly onto the load or into the tub.

Using the Liquid Bleach Dispenser

The bleach dispenser is a separate compartment at the left front of the tub opening.

Type 1

The bleach dispenser is connected to the inlet valve. The bleach is automatically diluted and dispensed at the proper time in the wash cycle.

NOTE

- The dispenser is activated twice to ensure complete dispensing of the bleach. Any liquid remaining in the dispenser at the end of the cycle is water, not bleach.

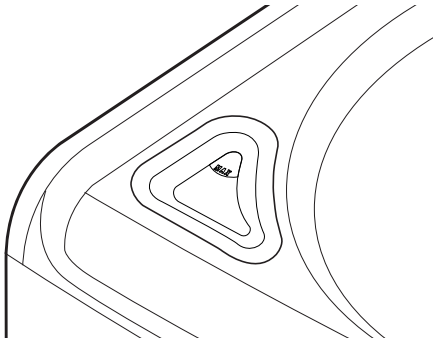

Type 2

When you pour the bleach into the bleach dispenser, the bleach is immediately added to the tub as it fills with water, safely diluting the bleach.

NOTE

- The dispenser cover cannot be removed. To clean the cover, wipe it with a damp paper towel.

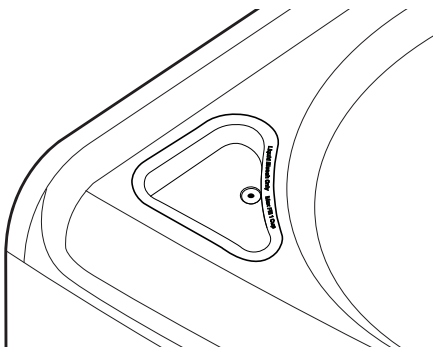

- 1 Check clothing care labels for special instructions.
- 2 Measure liquid bleach carefully, following instructions on the bottle.
 - High-efficiency washers use less water, so less bleach is needed. One half cup is enough for most loads.
- 3 Carefully pour the pre-measured amount of bleach directly into the bleach dispenser.
 - If you are using powdered bleach of any kind, pour it directly into the tub before adding the laundry. Never add powdered bleach to the liquid bleach dispenser.

! WARNING

- Do NOT mix chlorine bleach with ammonia or acids such as vinegar or rust/scale remover. Mixing chemicals like these can produce a lethal gas, resulting in severe injury or death.

NOTE

- Do not add powdered bleach to this dispenser. The bleach dispenser is designed to dispense liquid bleach only. Powdered or liquid color-safe bleach will not dispense properly.
- Do not place laundry items on top of the bleach dispenser when loading and unloading the washer.
- Always follow the manufacturer's recommendations when adding bleach. Never add more than one cup and do not exceed the maximum fill line since this can cause the bleach to be dispensed immediately, resulting in damage to fabrics. Using too much bleach can damage fabrics.
- Never pour undiluted liquid chlorine bleach directly onto the load or into the tub. Fabric damage can occur.
- Do not use color-safe bleach or Oxi products in the same cycle with liquid chlorine bleach.

Detergent Use

- This washer is designed for use with only HE (High-Efficiency) detergents. HE detergents produce fewer suds, dissolve more efficiently to improve washing and rinsing performance, and help to keep the interior of the washer clean. Using detergent that is not HE may cause oversudsing and unsatisfactory performance which could result in error codes, cycle failure, and machine damage.



Designed specially to use only HE (High-Efficiency) detergent

- For proper wash performance, always measure detergent using the measuring device provided by the detergent manufacturer. For an average load, use less than half of the recommended maximum. Use less detergent for soft water, light soil, or smaller loads.
- Never use more than the maximum amount of detergent recommended by the manufacturer. Using too much detergent can lead to oversudsing, poor rinsing, detergent buildup in clothing, and residue buildup that can contribute to odors in the machine.
- Use extra care when measuring 2X and 3X concentrated detergents because even a small amount extra can lead to problems.
- Detergents designated as HE-compatible may not provide optimal results.
- Do not use more than one detergent pod in the washer. Using too much detergent may cause oversudsing and unsatisfactory performance. Reduce detergent amount or add an extra rinse if detergent residue is left on fabrics. To add an extra rinse, press the **Extra Rinse** button.

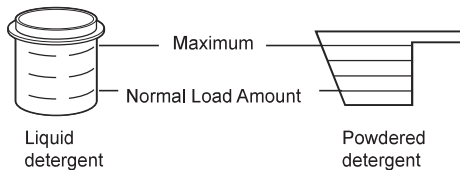

Control Panel

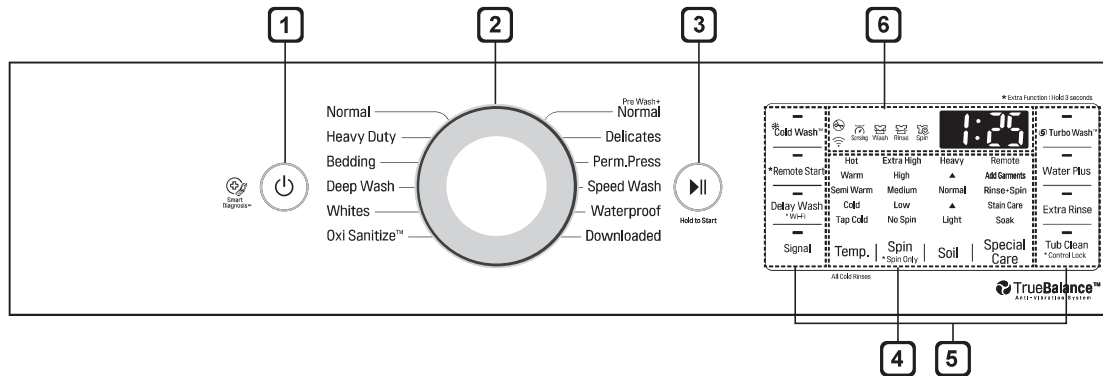

Control Panel Features

1 Power On/Off Button

Press to turn the washer on. Press again to turn the washer off. Pressing the **Power** button during a cycle will cancel that cycle and any load settings will be lost. The lid (door) will unlock after a brief pause.

NOTE

- If there is any water remaining in the tub after the washer shuts off, it will drain following 4 minutes delay. The washer can be restarted any time before the drain begins. However, once the water begins to drain, all functions will be suspended until the water has been completely drained and the washer shuts off.

2 Cycle Selector Knob

Turn this knob to select the desired cycle. Once the desired cycle has been selected, the standard presets will appear in the display. These settings can be adjusted using the cycle modifier buttons anytime before starting the cycle.

NOTE

- To protect your clothing, not all settings are available on all cycle selections.

3 Start/Pause Button

Press this button to start the selected cycle. If the washer is running, use this button to pause the cycle without losing the current settings.

NOTE

- If **Start/Pause** is not pressed within 60 minutes of selecting a cycle, the washer automatically turns off and all cycle settings are lost. Any water remaining in the tub will be drained.

4 Cycle Modifier Buttons

Use these buttons to adjust the water temperature, spin speed and soil level settings for the selected cycle. The current settings are shown in the display. Press the button for that option to select other settings.

5 Special Cycle and Option Buttons

Press these buttons to select special cycles or additional cycle options. Certain buttons also allow you to activate special functions by pressing and holding the button for three seconds.

6 Time and Status Display

The display shows the settings, estimated time remaining, options, and status messages for your washer. When the washer is turned on, the default settings in the display will illuminate.

Time and Status Display

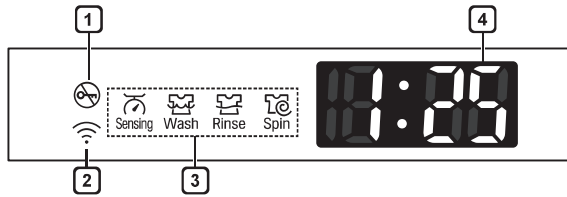

1 Door Lock Indicator

The Door Lock indicator will light up once a cycle has started. The indicator light will stay on until the cycle is paused, stopped or has finished.

2 Wi-Fi Connect Indicator

The indicator blinks during product registration and Wi-Fi setup and illuminates when the appliance is connected to a home Wi-Fi network.

3 Cycle Status Indicator

These LEDs illuminate when a cycle is selected to indicate which stages are included. When a cycle is running, the LED for the active stage blinks, and the LEDs for the remaining stages remain steady.

Once a stage is complete, the LED turns off. If a cycle is paused, the active stage LED stops blinking.

4 Estimated Time Remaining

When a cycle is selected, the default time for that cycle is displayed. This time will change as modifiers or options are selected. Once the **Start/Pause** button is pressed, the washer will measure the size of the load. The estimated time may change once the load size has been measured. If Delay Wash is set, the remaining delay time counts down until the cycle begins.

NOTE

- The time shown is only an estimate. This time is based on normal operating conditions. Several external factors (load size, room temperature, incoming water temperature, etc.) can affect the actual time.

Wash Cycles

Wash cycles are designed for the best wash performance for each type of load. Select the cycle that best matches the load contents for maximum wash performance and fabric care. See the Sorting Laundry section for best results, follow the fabric care labels on your garments. For a guide to fabric care symbols, see the Sorting Laundry section.

Turn the knob or press the button to select the desired cycle. When you select a wash cycle, the light for the corresponding wash cycle will turn on.

NOTE

- Whenever load weights are mentioned, assume 1 lb (0.45 kg) = 1 thick bath towel (dry).

Cycle	Description	Note
Normal	Use this cycle to wash all normal items, except delicate fabrics such as wool or silk. Fabric type : Cotton, linen, shirts, jeans, mixed loads	<ul style="list-style-type: none"> • Pressing the Start/Pause button without selecting a cycle will cause the Normal cycle to begin immediately, using the default settings.
Heavy Duty	This cycle is for washing heavily soiled laundry using more powerful wash motions. Fabric type : Heavily soiled cotton fabrics	<ul style="list-style-type: none"> • When washing large loads, in order to deliver the best performance, there will be brief periods of 2 minutes or more without agitation. These soak periods are part of the cycle's design, and are normal.
Bedding	This cycle is for washing blankets or bulky items. Fabric type : Large items such as blankets, comforters, and sheets	<ul style="list-style-type: none"> • Do not use this cycle to wash a mixed load of bedding and non-bedding items. • Use this cycle for items such as pillows, comforters, pet bedding and other articles which have difficulty absorbing water. • Do not wash excessively large items. If large/bulky items do not fit easily into the tub, there may not be enough room for them to move during washing. • Keep like items together; do not mix large/bulky items with smaller articles of clothing.
Deep Wash	Use this cycle to provide additional water and wash heavily soiled mixed items, except delicate fabrics.	-
Whites	This cycle is for washing white items only. Fabric type : Underwear, pillow covers, bed sheets, baby wear. (less than 12 lbs.)	-
Oxi Sanitize™	This wash cycle offers hygienic care for laundry when used in conjunction with bleach, without high energy consumption. Fabric type : Cotton, underwear, pillow covers, bed sheets, baby-clothing. (less than 11lbs.)	<ul style="list-style-type: none"> • Follow the product manufacturer's instructions for using Oxi products with this cycle. • Never load powdered products into the liquid bleach dispenser. Doing so can result in the product not being dispensed or being dispensed incorrectly. Powders can clog the bleach dispenser, resulting in leaks or damage to the washer or your clothing.

Cycle	Description	Note
Pre Wash+ Normal	Use this cycle to prewash stains without needing to hand wash. Prompt treatment helps to prevent stains from setting or odors from developing.	<ul style="list-style-type: none"> When chime sounds, press the Start/Pause button to unlock lid, add main detergent to dispenser, and insert remainder of laundry. If the Start/Pause is not pressed within about 3 minutes, the cycle continues. (If Signal is turned off, the chime won't sound.)
Delicates	<p>This cycle is for washing lingerie or sheer and lacy clothes which can easily be damaged.</p> <p>Fabric type : Dress shirts/blouses, nylons, sheer or lacy garments (less than 8 lb.)</p>	-
Perm.Press	<p>This cycle is for washing items such as wrinkle-free clothes or tablecloths to minimize wrinkles.</p> <p>Fabric type : Dress shirts/pants, wrinkle-free clothing, poly/cotton blend clothing, tablecloths</p>	-
Speed Wash	<p>Use the Speed Wash cycle to quickly wash lightly soiled clothing and small loads. For high wash and rinse efficiency, washing small loads of 2-3 lightly soiled garments is recommended.</p> <p>Fabric type : Lightly soiled and small loads</p>	<ul style="list-style-type: none"> Use very little detergent in this cycle. If you want additional rinsing, you can add extra rinses by using the Extra Rinse button.
Waterproof	<p>This cycle is used for washing waterproof material.</p> <p>Fabric type : Waterproof items such as water resistant clothing, mattress covers, outdoor clothes, and plastic mats (less than 14 lb.)</p>	<ul style="list-style-type: none"> Do not use any other wash cycle to wash waterproof fabrics. Do not use this cycle to wash a mixed load of waterproof and non-waterproof items. Check the washing instructions on items before using this cycle. Do not wash other fabrics using this cycle. <p>⚠ CAUTION</p> <ul style="list-style-type: none"> If waterproof material laundry is washed in a course other than Waterproof, it may result in injury or damage to the washer, clothes, walls, floor, and surrounding objects due to abnormal vibration.
Downloaded	If you download a cycle using the function, it will be placed in the Downloaded cycle position. Choose the Downloaded cycle to run the new cycle.	<ul style="list-style-type: none"> The default cycle for this position is Small Load, used for normally soiled loads with just a few items. The Small Load cycle is also available for download.

Cycle Guide

Cycle	Wash Temp.	Spin Speed	Soil Level	Soak	Stain Care	Cold Wash	Extra Rinse	Water Plus	Turbo Wash™
Normal	Hot	Extra high	Heavy						
	Warm	High							
	Semi Warm	Medium	Normal	●	●	●	●	●	●
	Cold								
	Tap cold	No spin	Light						
Heavy Duty	Hot	Extra high	Heavy						
	Warm	High							
	Semi Warm	Medium	Normal	●	●		●	●	●
	Cold	Low							
	Tap Cold	No spin	Light						
Bedding	Hot		Heavy						
	Warm								
	Semi Warm	Medium	Normal	●		●	●		
	Cold	Low							
	Tap Cold	No spin	Light						
Deep Wash	Hot	Extra high	Heavy						
	Warm	High							
	Semi Warm	Medium	Normal	●			●	●	
	Cold	Low							
	Tap Cold	No spin	Light						
Whites	Hot	Extra high	Heavy						
	Warm	High							
	Semi Warm	Medium	Normal	●			●	●	●
		Low							
		No spin	Light						

● = available option, ■ = default setting

Cycle	Wash Temp.	Spin Speed	Soil Level	Soak	Stain Care	Cold Wash	Extra Rinse	Water Plus	Turbo Wash™
Oxi Sanitize™	Hot	Extra High	Heavy						
		High							
		Medium	Normal				●	●	●
		Low							
		No Spin	Light						
Pre Wash+ Normal	Hot	Extra high							
	Warm	High							
	Semi Warm	Medium	Normal	●			●	●	●
	Cold	Low							
	Tap Cold	No spin	Light						
Delicates			Heavy						
	Warm								
	Semi Warm		Normal	●			●	●	
	Cold	Low							
	Tap Cold	No spin	Light						
Perm. Press			Heavy						
	Warm	High							
	Semi Warm	Medium	Normal	●		●	●	●	●
	Cold	Low							
	Tap Cold	No spin	Light						

● = available option, ■ = default setting

28 OPERATION

Cycle	Wash Temp.	Spin Speed	Soil Level	Soak	Stain Care	Cold Wash	Extra Rinse	Water Plus	Turbo Wash™
Speed Wash		Extra high	Heavy	●			●	●	●
	Warm	High							
	Semi Warm	Medium	Normal						
	Cold	Low							
	Tap Cold	No spin	Light						
Waterproof			Heavy				●	●	
	Warm								
	Semi Warm		Normal						
	Cold	Low							
	Tap Cold	No spin	Light						
Downloaded Default: Small Load	Hot	Extra high	Heavy	●	●	●	●	●	●
	Warm	High							
	Semi Warm	Medium	Normal						
	Cold								
	Tap Cold	No spin	Light						

● = available option, ■ = default setting

Cycle Modifier Buttons

Each cycle has default settings that are selected automatically. You may also customize these settings using the cycle modifier buttons. Press the button for the desired modifier until the indicator light for the desired setting is lit. The washer automatically adjusts the water level for the type and size of wash load for best results and maximum efficiency. Due to the high-efficiency nature of this product, water levels may be much lower than expected. This is normal and cleaning/rinsing performance will not be compromised.

NOTE

- To protect your garments, not every wash temperature, spin speed, soil level, or option is available with every cycle. A chime will sound and the LED will not light if a selection is not allowed.

Hot	Extra High	Heavy	Remote
Warm	High	▲	Add Garments
Semi Warm	Medium	Normal	Rinse+Spin
Cold	Low	▲	Stain Care
Tap Cold	No Spin	Light	Soak
Temp.	Spin * Spin Only	Soil	Special Care

Temp.

Temp. selects the wash and rinse temperature combination for the selected cycle.

- Press the **Temp.** button until the indicator light for the desired setting is lit.
- All rinses use tap cold water.

NOTE

- Select the water temperature suitable for the type of load you are washing. Follow the fabric care labels on the garment for best results.

Spin

Higher spin speeds extract more water from clothes, reducing drying time and saving energy.

- Press the **Spin** button until the desired speed is selected.
- Some fabrics, such as delicates, require a slower spin speed. To protect your clothing, not all spin speeds are available for all cycles.

Soil

Adjusting the soil level setting will modify the cycle times and/or wash actions.

- Press the **Soil** button until the desired soil level is selected.

NOTE

- This feature needs more time for heavily soiled loads or less time for lightly soiled loads.

Special Care

Press the **Special Care** button to select additional features, such as Soak, Stain Care, and Rinse+Spin.

- Pressing the **Special Care** button before selecting a cycle will automatically default to the Normal cycle with the Soak feature selected.

Special Care Features

Press the **Special Care** button to select specialized cycles or add features to standard cycles. Press the button repeatedly to move through the available features.

NOTE

- To protect your garments, not every feature is available with every cycle.
- If the **Start/Pause** button is not pressed within 60 minutes to start the cycle, the washer will shut off and all settings will be lost.

Soak

This option provides a 30-minute presoak prior to the start of the selected cycle. Use the Soak option to presoak garments to help remove difficult spots or stains on fabrics. At the end of the presoak time, the selected cycle will begin with the same water used for the soak.

NOTE

- You cannot select the Soak option for the Tub Clean cycle.

Stain Care

Use this option for heavily soiled loads that need improved stain treatment. When Stain Care is selected, the wash cycle will begin with warm water to help prevent the setting of certain types of stains. Then, as the cycle progresses, hot water will be added to gradually increase the water temperature to help remove stains that require treatment at higher temperatures.

NOTE

- Best results are obtained with smaller loads (less than 6 lb.)
- If you select Stain Care, the Cold Wash option is not available.

Rinse+Spin

Select this option to rinse and spin a load separately from a regular cycle. This can be helpful in preventing fresh stains from setting in fabrics. You can change the spin speed by pressing the **Spin** button.

- 1 Press the **Power** button to turn on the washer.
- 2 Press the **Special Care** button repeatedly until Rinse+Spin is selected.
- 3 Press the **Start/Pause** button.

Special Drain Feature

This washer is equipped with a special drain feature that is designed to make your washer as safe as possible. If the washer is paused or shut off while there is still water in the tub, the water will drain automatically after several minutes of inactivity. This helps keep children safe by reducing the possibility of water remaining in the tub.

Any water remaining in the tub will automatically drain 4 minutes after the washer has shut off. If the washer is paused and the **Start/Pause** button is not pressed within 60 minutes, the washer will shut off and all cycle settings will be lost. And any water remaining in the tub will be drained.

The washer can be turned on or restarted any time before the drain begins. However, once the washer begins to drain, all controls and functions will be disabled until the water has been completely drained and the washer shuts off.

Add Garments

If you've forgotten to add an item or need to remove foreign objects like coins or keys after the cycle has started, the best time to do so is while the Add Garments indicator is on. Once the indicator turns off, adding garments may affect the cycle time or wash performance.

- 1 Press **Start/Pause**. The cycle pauses and the lid (door) unlocks.
- 2 Open the lid (door), add garments or remove foreign objects, and close the lid (door).
- 3 Press the **Start/Pause** button to start the cycle. The cycle continues automatically.

Option Buttons

Your washer features several additional cycle options that customize cycles to meet your individual needs. To use these options, select the desired option after selecting the desired cycle.

After selecting the desired cycle and settings, press the cycle option button(s) for the option(s) you would like to add. The button will light when that option is selected. If the selected option is not allowed for the selected cycle, the chime will sound twice to alert you and the LED will not illuminate.

NOTE

- To protect your garments, not every feature is available with every cycle.

Cold Wash

This option saves energy by using cooler water while increasing the wash and rinse times to maintain wash performance.

NOTE

- Wash time will increase up to several minutes with this option.
- For best wash results, only wash small loads (less than 8 lb.) with this option.

Delay Wash

Once you have selected the cycle and other settings, press this button to delay the start of the wash cycle.

Each press of the button increases the delay time by 1 hour, for up to 19 hours. Once the desired delay time is set, press the **Start/Pause** button to start the delay time.

NOTE

- If the **Start/Pause** button is not pressed to begin the delay time, the washer will automatically shut off after 60 minutes and all cycle settings will be lost.

Signal

The washing machine plays a melody when the wash cycle has finished. The volume of the melody is adjusted using the Signal button.

- Press the **Signal** button repeatedly to adjust the volume of the signal.
- The signal can be turned On or Off. When the LED on the button turns off, the signal is off. The signal volume can be adjusted at any time as long as the washer is turned on.

Turbo Wash™

Adding the Turbo Wash™ option to a cycle reduces the length of the cycle while maintaining a similar wash performance.

NOTE

- The Turbo Wash™ option cannot be used with all cycles.
- Turbo Wash™ defaults On for Normal, Pre Wash+Normal and Speed Wash cycles.

Water Plus

Use this option to add extra water to the wash cycle for better wash performance (stain treatment) with large or bulky items.

NOTE

- If the washer reaches its maximum water level, the **Water Plus** button will have no effect.
- To add more water while a cycle is running, pause the cycle before pressing Water Plus.
- Selecting the Water Plus option with the Normal cycle automatically changes the cycle to the Deep Wash cycle.

Extra Rinse

This option will add an extra rinse to the selected cycle. Use this option to help ensure the removal of detergent or bleach residue from fabrics. Liquid fabric softener, if used, is always dispensed in the final rinse.

- Pressing the **Extra Rinse** button twice will add two additional rinses to the cycle.

NOTE

- You cannot select the Extra Rinse option with the Spin Only option and Tub Clean cycle.
- Selecting the Extra Rinse option with the Normal cycle automatically changes the cycle to the Deep Wash cycle.

Tub Clean

Use this cycle to clean the tub of your washing machine. See the Maintenance section.

Control Lock

Use this option to disable the controls. This feature can prevent children from changing cycles or operating the machine. The feature does not lock the lid (door). Once the Control Lock is set, it must be deactivated before any controls, except the **Power** button, can be used. Once the washer has shut off, the **Power** button will allow the machine to be turned on, but the controls will still be locked. When the controls are locked,  will display alternately with the estimated time remaining.

- Press and hold the **Signal** button for 3 seconds to activate or deactivate Control Lock.

NOTE



- Once the controls are locked, they must be manually unlocked to restore operation.

SMART FUNCTIONS

LG SmartThinQ Application

The LG SmartThinQ application allows you to communicate with the appliance using a smartphone.

Before Using LG SmartThinQ

- For appliances with the  or  logo
- 1 Use a smartphone to check the strength of the wireless router (Wi-Fi network) near the appliance.
 - If the distance between the appliance and the wireless router is too far, the signal strength becomes weak. It may take a long time to register or installation may fail.
 - 2 Turn off the **Mobile data** or **Cellular Data** on your smartphone.

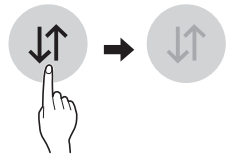

- 3 Connect your smartphone to the wireless router.

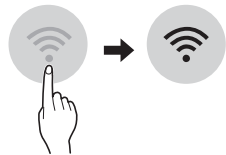

NOTE



- To verify the Wi-Fi connection, check that **Wi-Fi**  icon on the control panel is lit.
- The appliance supports 2.4 GHz Wi-Fi networks only. To check your network frequency, contact your Internet service provider or refer to your wireless router manual.
- LG SmartThinQ is not responsible for any network connection problems or any faults, malfunctions, or errors caused by network connection.
- The surrounding wireless environment can make the wireless network service run slowly.

- If the appliance is having trouble connecting to the Wi-Fi network, it may be too far from the router. Purchase a Wi-Fi repeater (range extender) to improve the Wi-Fi signal strength.
- The network connection may not work properly depending on the Internet service provider.
- The Wi-Fi connection may not connect or may be interrupted because of the home network environment.
- If the appliance cannot be registered due to problems with the wireless signal transmission, unplug the appliance and wait about a minute before trying again.
- If the firewall on your wireless router is enabled, disable the firewall or add an exception to it.
- The wireless network name (SSID) should be a combination of English letters and numbers. (Do not use special characters.)
- Smartphone user interface (UI) may vary depending on the mobile operating system (OS) and the manufacturer.
- If the security protocol of the router is set to **WEP**, network setup may fail. Change the security protocol (**WPA2** is recommended), and register the product again.

Installing the LG SmartThinQ Application

Search for the LG SmartThinQ application from the Google Play Store or Apple App Store on a smart phone. Follow instructions to download and install the application.

LG SmartThinQ Application Features

- For appliances with the  or  logo

Washer Cycle (Remote Start, Downloaded)

Set or download any preferred cycle and operate by remote control.

Tub Clean Coach

This function shows how many cycles remain before it is time to run the Tub Clean cycle.

Smart Diagnosis™

This function provides useful information for diagnosing and solving issues with the appliance based on the pattern of use.

Energy Monitoring

The washer energy usage is affected by the cycles and options so you may see some changes in energy usage from one cycle to another.

Push Alerts

When the cycle is complete or the appliance has problems, you have the option of receiving push notifications on a smart phone.

Settings

Set the product nickname and delete product.

NOTE

- If you change your wireless router, Internet service provider, or password, delete the registered appliance from the LG SmartThinQ application and register it again.
- This information is current at the time of publication. The application is subject to change for product improvement purposes without notice to users.

Using Washer Cycle

Remote Start

Use a smart phone to control the appliance remotely or check to see how much time is left in the cycle.

Using Remote Start

- 1 Press the **Power** button.
- 2 Load the laundry.
- 3 Press and hold **Remote Start** button for 3 seconds to enable the Remote Start function.
- 4 Start a cycle from the LG SmartThinQ application on your smart phone.

NOTE

- Once the Remote Start mode is enabled, you can start a cycle from the LG SmartThinQ smartphone application. If the cycle is not started, the machine will wait to start the cycle until it is turned off remotely from the application or the Remote Start mode is disabled.
- When Remote Start is turned on, the door is automatically locked.

Disabling Remote Start

When the Remote Start is activated, press and hold the **Remote Start** button for 3 seconds.

Downloaded

Download new and specialized cycles that are not included in the standard cycles on the appliance.

Appliances that have been successfully registered can download a variety of specialty cycles specific to the appliance.

Only one cycle can be stored on the appliance at a time.

Once cycle download is completed in the appliance, the appliance keeps the downloaded cycle until a new cycle is downloaded.

Wireless LAN Module Specifications

Model	LCW-004
Frequency Range	2412 - 2462 MHz
Output Power (Max)	IEEE 802.11 b : 22.44 dBm
	IEEE 802.11 g : 24.68 dBm
	IEEE 802.11 n : 24.11 dBm

FCC Notice (For transmitter module contained in this product)

This equipment has been tested and found to comply with the limits for a Class B digital device, pursuant to Part 15 of the FCC Rules. These limits are designed to provide reasonable protection against harmful interference in a residential installation. This equipment generates, uses, and can radiate radio frequency energy and, if not installed and used in accordance with the instructions, may cause harmful interference to radio communications. However, there is no guarantee that interference will not occur in a particular installation. If this equipment does cause harmful interference to radio or television reception, which can be determined by turning the equipment off and on, the user is encouraged to try to correct the interference by one or more of the following measures:

- Reorient or relocate the receiving antenna.
- Increase the separation between the equipment and the receiver.
- Connect the equipment to an outlet on a circuit different from that to which the receiver is connected.
- Consult the dealer or an experienced radio/TV technician for help.

This device complies with part 15 of the FCC Rules. Operation is subject to the following two conditions:

- 1) This device may not cause harmful interference and
- 2) This device must accept any interference received, including interference that may cause undesired operation of the device.

Any changes or modifications in construction of this device which are not expressly approved by the party responsible for compliance could void the user's authority to operate the equipment.

FCC RF Radiation Exposure Statement

This equipment complies with FCC radiation exposure limits set forth for an uncontrolled environment. This transmitter must not be co-located or operating in conjunction with any other antenna or transmitter.

This equipment should be installed and operated with a minimum distance of 20 cm (7.8 inches) between the antenna and your body. Users must follow the specific operating instructions for satisfying RF exposure compliance.

Open Source Software Notice Information

To obtain the source code under GPL, LGPL, MPL, and other open source licenses, that is contained in this product, please visit <http://opensource.lge.com>. In addition to the source code, all referred license terms, warranty disclaimers and copyright notices are available for download.

LG Electronics will also provide open source code to you on CD-ROM for a charge covering the cost of performing such distribution (such as the cost of media, shipping, and handling) upon email request to opensource@lge.com. This offer is valid for a period of three years after our last shipment of this product. This offer is valid to anyone in receipt of this information.

Smart Diagnosis™ Function

Should you experience any problems with the appliance, it has the capability of transmitting data via your telephone to the LG Customer Information Center. NFC or Wi-Fi equipped models can also transmit data to a smartphone using the LG SmartThinQ application.

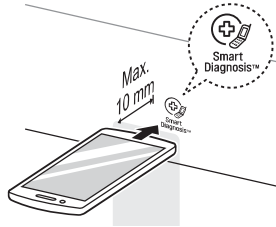

Smart Diagnosis™ through the Customer Information Center

- For appliances with the  or  logo

This method allows you to speak directly to our trained specialists. The specialist records the data transmitted from the appliance and uses it to analyze the issue, providing a fast and effective diagnosis.

- 1 Call the LG Electronics Customer Information Center at:
(LG U.S.A.) 1-800-243-0000
(LG Canada) 1-888-542-2623
- 2 When instructed to do so by the call center, place the mouthpiece of the phone close to the Smart Diagnosis™ icon. Do not press any other buttons.
- 3 Press and hold **Temp.** button for three seconds.
- 4 Keep the phone in place until the tone transmission has finished.
 - For best results, do not move the phone while the tones are being transmitted.
 - If the call center agent is not able to get an accurate recording of the data, you may be asked to try again.
- 5 Once the countdown is over and the tones have stopped, resume your conversation with the call center agent, who will then be able to assist you using the information transmitted for analysis.

NOTE

- Smart Diagnosis™ cannot be activated unless the appliance can be turned on using the **Power** button. If the appliance cannot be turned on, troubleshooting must be done without using Smart Diagnosis™.
- For best results, do not move the phone while the tones are being transmitted.
- If the call center agent is not able to get an accurate recording of the data, you may be asked to try again.
- The Smart Diagnosis™ function depends on the local call quality.
- Bad call quality may result in poor data transmission from your phone to the call center, which could cause Smart Diagnosis™ to malfunction.

LG SmartThinQ Smart Diagnosis™

- For appliances with the  or  logo

Use the Smart Diagnosis feature in the LG SmartThinQ application for help diagnosing issues with the appliance without the assistance of the LG Customer Information Center.

Follow the instructions in the LG SmartThinQ application to perform a Smart Diagnosis using your smartphone.

NOTE

- Smart Diagnosis™ cannot be activated unless the appliance can be turned on using the **Power** button. If the appliance cannot be turned on, troubleshooting must be done without using Smart Diagnosis™.

MAINTENANCE

WARNING

To reduce the risk of fire, electric shock, or injury to persons, read this entire owner's manual, including the Important Safety Instructions, before operating this washer.

- Unplug the washer before cleaning to avoid the risk of electric shock. Failure to follow this warning can cause serious injury, fire, electric shock, or death.
- Do not use volatile substances (benzene, paint thinner, alcohol, acetone, etc.), abrasive cleaners, or detergents with strong chemical components when cleaning the washer. Doing so may cause discoloration or damage to the machine, or may cause a fire.
- Certain internal parts are intentionally not grounded and may present a risk of electric shock only during servicing. Service personnel-do not contact the following parts while the appliance is energized. : pump, motor, noise filter cover, and heater (on applicable models).

Regular Cleaning

Care After Wash

After the cycle is finished, wipe the lid (door) and the inside of the lid (door) seal to remove any moisture.

- Leave the lid (door) open to dry the tub interior.
- Wipe the body of the washer with a dry cloth to remove any moisture.

Cleaning the Exterior

Proper care of your washer can extend its life.

Lid (Door):

Wash with a damp cloth on the outside and inside and then dry with a soft cloth.

Exterior:

- Immediately wipe off any spills.
- Wipe with a damp cloth.
- Do not touch the surface or the display with sharp objects.

Care and Cleaning of the Interior

- Use a towel or soft cloth to wipe around the washer lid (door) opening and lid (door) glass.
- Always remove items from the washer as soon as the cycle is complete. Leaving damp items in the washer can cause wrinkling, color transfer, and odor.
- Run the Tub Clean cycle once a month, or more often if needed, to remove detergent buildup and other residue.

Cleaning the Tub

Over time, residue may build up in the tub, leading to mildew or a musty odor. Run the Tub Clean cycle monthly to remove residue and prevent odor. Run the cycle more often under heavy use conditions or if odor is already present.

- 1 Remove any clothing from the tub.
- 2 Add cleaning agents.

Cleaner	Instructions
Tub cleaner	Follow manufacturer's recommendations.
Lime scale remover	
Liquid chlorine bleach	Add to main wash liquid detergent dispenser.
Powdered cleaner	Follow manufacturer's recommendations.
Cleaning tablets	Place directly into washer tub.

- For other tub cleaning products, follow the cleaner manufacturer's instructions and recommendations.
 - Do not exceed the maximum fill line when adding bleach or powdered cleaners. Powdered cleaners may remain in the tub after cleaning.
- 3 Close the lid (door) and press the **Power** button to turn the washer on.
 - 4 Turn the knob or press the cycle buttons to select the **Tub Clean** cycle then press the **Start/Pause** button to begin the cycle.
 - 5 After the cycle ends, open the lid (door) and allow the tub interior to dry completely.

NOTE

- Never load laundry while using Tub Clean. The laundry may be damaged or contaminated with cleaning products. Make sure to run the Tub Clean cycle only when the tub is empty.
- Leave the lid (door) open after finishing the laundry, to keep the tub clean.
- Tub Clean should be repeated monthly.
- If mildew or musty smell already exists, run Tub Clean once a week for three consecutive weeks.
- Do not exceed the manufacturer's recommended amount when adding bleach or powdered cleaners. Powdered cleaner may remain in the tub after cleaning.

Removing Mineral Buildup

In areas with hard water, mineral scale can form on internal components of the washer. Periodically clean the mineral buildup on the internal components to extend the lifespan of the washer. Use of a water softener is recommended in areas with hard water.

- Use a descaler, such as Washer Magic®, to remove visible mineral buildup on the washer tub.
- After descaling, always run the Tub Clean cycle before washing clothing.
- Mineral scale and other spots may be removed from the stainless steel tub using a soft cloth soaked in stainless steel cleaner.
- Do not use steel wool or abrasive cleaners.

Leaving the Lid (Door) Open

- If the washer will not be used for several days, leave the lid (door) open overnight to allow the tub to dry.

Cleaning the Dispenser Drawer

Detergent and fabric softener may build up in the dispenser drawer. Remove the drawer and inserts and check for buildup once or twice a month.

- 1 Remove the drawer by pulling it straight out until it stops. Lift up on the front of the drawer and pull it completely out.

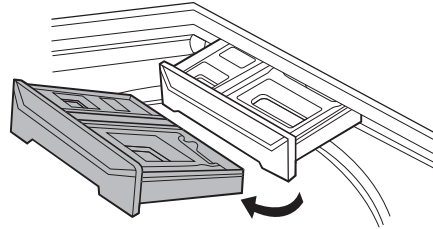

- 2 Remove the inserts from the two compartments.

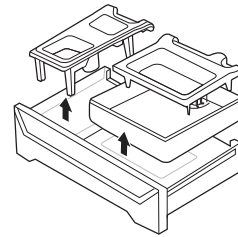

- 3 Clean the inserts and drawer with warm water.
 - Use a soft cloth or brush for cleaning and to remove any residue.

⚠ WARNING

- Do not spray water inside the washer. Doing so may cause fire or electric shock.

- 4 Wipe off any moisture with a dry towel or cloth after cleaning.
- 5 To clean the drawer opening, use a small, non-metal brush to clean the recess. Remove all residue from the upper and lower parts of the recess.
- 6 Return the inserts to the proper compartments and replace the drawer.
 - Set the drawer into the opening at an angle, then lower it and slide it into place.

NOTE

- If you use a descaler or tub cleaner during the Tub Clean cycle, use the Rinse+Spin option to rinse the washer tub before running your next wash cycle.

Cleaning the Bleach Dispenser

Bleach may build up on the bleach dispenser cover. Check for buildup and clean the cover once or twice a month.

Type 1

Remove the cover from the bleach dispenser. Clean the cover and the opening with warm water.

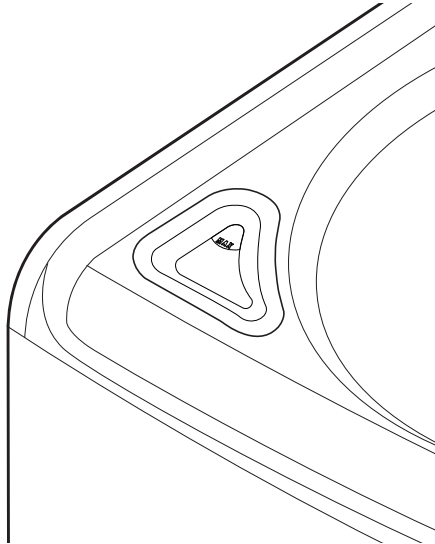

Type 2

The cover cannot be separated from the dispenser. Clean the cover using a brush and warm water.

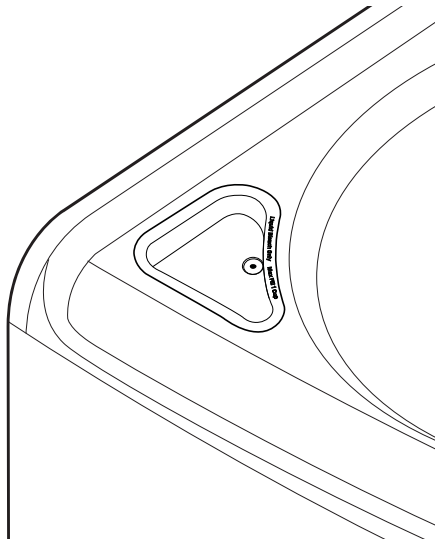

Cleaning the Water Inlet Filters

If the washer does not fill properly, an error message will show on the display. The inlet valve filter screens could be plugged by hard water scale, sediment in the water supply, or other debris.

⚠ CAUTION

- The inlet screens protect the delicate parts of the inlet valve from being damaged by particles that could enter the valves with the water supply. Operating the washer with these filters removed could cause a valve to stick open resulting in flooding and/or property damage.
- Do not use the washer without the inlet filters. If you use the washer without the inlet filters it will cause leaks and malfunction.
- If you use the washer in an area with hard water, the inlet filter may clog due to lime buildup.

- 1 Turn off both water faucets completely.
- 2 Unscrew the hot and cold water hoses from the back of the washer.
- 3 Carefully remove the filters from the water valves.
- 4 Remove foreign objects and soak the filters in white vinegar or a lime scale remover. If using a lime scale remover, follow the manufacturer's instructions. Be careful not to damage the filters while cleaning them.
- 5 Rinse filters thoroughly and press them back into place.
- 6 Flush then reattach the water hoses. Before reattaching the hoses, flush the hoses and water lines by running several gallons of water into a bucket or drain, preferably with the faucets wide open for maximum flow.

NOTE

- An *IE* message may blink on the display when the water pressure is low or an inlet filter is clogged with dirt. Clean the inlet filter.

Care in Cold Climates

Storing the Washer

If the washer will not be used for an extended period of time and is in an area that could be exposed to freezing temperatures, perform the following steps to protect the washer from damage.

Make sure the tub is empty before following these steps.

- 1 Turn off the water supply.
- 2 Disconnect hoses from water supply and drain water from hoses.

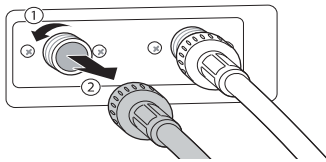

- 3 Plug the power cord into a properly grounded electrical outlet.
- 4 Add 1 gallon of nontoxic recreational vehicle (RV) antifreeze to the empty tub and close the lid (door). Never use automotive antifreeze.
- 5 Press the **Power** button, then select **Spin**.
- 6 Press the **Start/Pause** button to start the drain pump.
- 7 Allow the drain pump to run for one minute, then press the **Power** button to shut off the washer. This will expel some of the antifreeze, leaving enough to protect the washer from damage.
- 8 Unplug the power cord, dry the tub interior with a soft cloth, and close the lid (door).
- 9 Store the washer in an upright position.
- 10 Remove the inserts from the dispenser. Drain any water in the compartments and let them dry.
- 11 To remove the antifreeze from the washer after storage, run a complete Speed Wash cycle using detergent.
 - Do not add laundry to this cycle.

When the Water Line is Frozen

- 1 Turn off the faucets connected with the water lines.
- 2 Pour hot water on the frozen faucets to thaw the water lines and remove water lines.
- 3 Immerse the water lines in hot water to thaw them.
- 4 Connect the water lines with the water inlets of the washer and with the faucets. See Connecting the Water Lines for details.
- 5 Turn on the faucets.
- 6 Press the **Power** button.
- 7 Press **Special Care** repeatedly to select the Rinse+Spin cycle.
- 8 Press the **Start/Pause** button. Verify the water fills properly.

When the Drain Line is Frozen

- 1 Pour hot water in the washer tub and close the lid. Wait for 1-2 hours.
- 2 Press the **Power** button after thawing.
- 3 Press **Special Care** repeatedly to select the Rinse+Spin cycle.
- 4 Press the **Start/Pause** button. Check to make sure the water drains.