

READ AND SAVE THESE INSTRUCTIONS

Whole Room Air Purifier Owner's Guide

LEER Y GUARDAR ESTAS INSTRUCCIONES

Guía para el usuario del Purificador de Aire para todo el ambiente

LISEZ ET CONSERVEZ CES INSTRUCTIONS

Manuel d'utilisation du Purificateur d'Air pour Espace Entier

www.vornado.com

model AC550

Designed, engineered and supported in Andover, Kansas.

Pensado, diseñado y respaldado en Andover, Kansas.

Conception, mise au point et soutien technique effectués à Andover, au Kansas.

Questions or comments?
¿Preguntas o comentarios?
Questions ou commentaires?



www.vornado.com



consumerservice@vornado.com



800.234.0604

Contents

Important Instructions	4
The Vornado Difference	6
Product Information	7
True HEPA Filtration.....	8
Automatic Filter Refill Program	8
Understanding CADR	9
Control Panel	10
How to Use	11
User Tips	13
Filter Replacement.....	14
Storage	16
Cleaning and Maintenance	17
Troubleshooting	18
Warranty.....	19

Español p. 20

Français p. 36

IMPORTANT INSTRUCTIONS

READ ALL INSTRUCTIONS BEFORE USING THIS PRODUCT

This appliance has a polarized plug. (One blade is wider than the other.) To reduce the risk of electric shock, this plug is intended to fit in a polarized outlet only one way. If the plug does not fit fully in the outlet, reverse the plug. If it still does not fit, contact a qualified electrician. Do not attempt to defeat this safety feature.

WARNING – To reduce the risk of fire or electric shock, do not use this product with any solid state control device. Unplug the appliance from the power supply before cleaning, moving or servicing.

- **Do** unplug your Vornado Air Purifier before cleaning.
- **Do** clean your Vornado Air Purifier regularly. Refer to the Cleaning and Maintenance instructions provided. Never clean the Vornado Air Purifier in any manner other than as instructed in this manual.
- **Do Not** tamper with or modify this product in any way.
- **Do Not** use gasoline, thinners, solvents, ammonias or other chemicals for cleaning.
- **Do Not** immerse this product in water or allow water to drip into the motor housing.
- **Do Not** use near furnaces, fireplaces, stoves or other high-temperature heat sources.
- **Do Not** block the top air vent so purified air cannot be circulated throughout the room.
- **Do Not** use this product outdoors.

IMPORTANT INSTRUCTIONS

READ ALL INSTRUCTIONS BEFORE USING THIS PRODUCT

- **Do Not** use this product on wet surfaces.
- **Do Not** use this product in a bathtub or shower.
- **Do Not** operate any purifier with a damaged cord or plug. Discard purifier or return to an authorized service facility for examination and/or repair.
- **Do Not** carry this product by the cord, or use the cord as a handle.
- **Do Not** attempt to repair or replace parts, except for Filters.
- **Do Not** run cord under carpeting. Do not cover cord with throw rugs, runners, or similar coverings. Do not route cord under furniture or appliances. Arrange cord away from traffic area and where it will not be tripped over.
- **Do** use common sense when using this product and/or any electrical appliance.

WARNING: The manufacturer assumes no responsibility for damage or injury caused by failure to follow these instructions, improper product use, or unauthorized product modification. Any such actions will invalidate the product warranty.

Note: This equipment has been tested and found to comply with the limits for a Class B digital device, pursuant to Part 15 of the FCC Rules. These limits are designed to provide reasonable protection against harmful interference in a residential installation. This equipment generates, uses and can radiate radio frequency energy and, if not installed and used in

accordance with the instructions, may cause harmful interference to radio communications. However, there is no guarantee that interference will not occur in a particular installation. If this equipment does cause harmful interference to radio or television reception, which can be determined by turning the equipment off and on, the user is encouraged to try to correct the interference by one or more of the following measures:

- Reorient or relocate the receiving antenna.
- Increase the separation between the equipment and receiver.
- Connect the equipment into an outlet on a circuit different from that to which the receiver is connected.
- Consult the dealer or an experienced radio/ TV technician for help.

This device complies with part 15 of the FCC Rules. Operation is subject to the following two conditions: (1) This device may not cause harmful interference, and (2) this device must accept any interference received, including interference that may cause undesired operation.

This Class B digital apparatus complies with Canadian ICES-003. Cet appareil numérique de la classe B est conforme à la norme NMB-003 du Canada.

Trust.

It is said that trust isn't given, but earned. For decades Vornado has been earning the trust of our customers by offering them only the best. Vornado provides the highest level of performance, coupled with the highest level of support available. Complete satisfaction with no exceptions – this is Vornado's promise to you. If you are not satisfied for any reason, please contact us. Knowledgeable representatives are available at 1-800-234-0604 from 7:00 AM to 6:00 PM CST. A wealth of additional support is also available online at www.vornado.com. On behalf of myself and the entire staff at our Andover, Kansas headquarters – thank you for selecting Vornado.

Sincerely,
Randy Brillhart
CEO, Vornado Air



Find our complete product line at www.vornado.com

The Vornado Difference

Filter All The Air

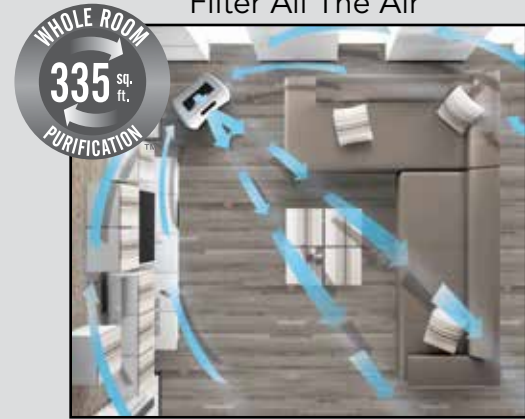

An air purifier, even at 99.97%* capture rate, is only effective if it is able to pull large volumes of air through the unit and disperse the purified air throughout the room. Vornado has combined a powerful blower with precise aerodynamics, to effectively clean all the air in the room. With Vornado's two stage Carbon and True HEPA filtration – the air leaving the unit is 99.97%* filtered of airborne particles such as dust, pollen, dander, smoke, bacteria, mold spores and dust mite debris.

*0.3 microns or larger.

Product Information

1 Front Panel

2 2 Plastic Support Filter Frames

The frame secures both carbon and HEPA filters in place.

3 2 Carbon Filters

Captures larger initial particles and odors passing through the unit.

4 2 HEPA Filters

Captures 99.97% of particles 0.3 microns or larger passing through the unit, allowing only filtered air back into the environment.

5 Control Panel

LED display and push button controls for easy and intuitive operation.

6 Dust Sensor and Access Door

The Dust Sensor continuously monitors the amount of particulates in the air.

7 Power Cord

Convenient 6 ft. cord.

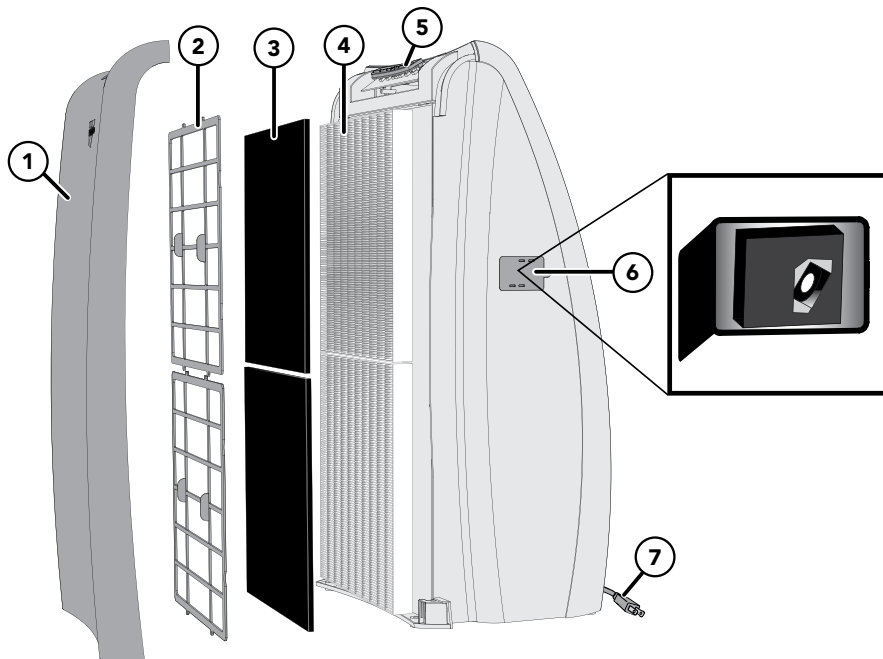

True HEPA Filtration



Vornado Whole Room Air Purifiers Feature Precision True HEPA Calibration

Without properly calibrated airflow, products with a True HEPA Filter will not achieve their full filtration potential. Gaps, poorly sealed filter housings, and excessive air velocity all reduce the ef-

fectiveness of the product. Independent testing laboratory verifies that the precise calibration of a Vornado Air Purifier allows it to perform at True HEPA standards.

2 Stage Filtration

Carbon filtration captures odors and prolongs HEPA filter life. HEPA filtration captures 99.97% of particles 0.3 microns or larger, to effectively clean large volumes of air.

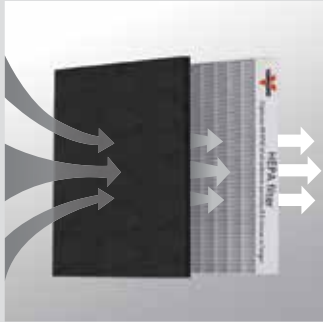

Automatic Filter Refill Program

A convenient and hassle-free way to receive regular shipments of Vornado Filters, direct to your door. Eliminate the hassle of remembering to reorder. Maintain the high efficiency of your Vornado Purifier by regularly replacing used Filters with fresh new ones. How it works: You select a plan and Vornado will send replacement Filters at the recommended maintenance interval. To sign up, visit www.vornado.com, email consumerservice@vornado.com or call 1-800-234-0604. Cancel at anytime.



Part # MD1-0023



Part # MD1-0022

Understanding CADR

What is CADR?

CADR stands for "Clean Air Delivery Rate," which indicates the volume of filtered air delivered by an air purifier. CADR ratings show the effectiveness of the air purifier is at capturing fine particles. Higher CADR rates indicate improved performance in all room sizes.

Note: This air cleaner is suggested for use in a single, closed room up to 335 square feet. Portable air cleaners will be much more effective in rooms when all the doors and windows are closed.

Tested per ANSI/AHAM AC-1 National Standard.

CADR

Clean Air Delivery Rate

Room Size	Room Changes/Hour
14x14	8.3
16x16	6.4
18x18	5.0

smoke 205

dust 218

pollen 245

Source: Independent Testing Laboratory.

This value represents performance that can be expected within the first 72 hours or operation. Subsequent use may vary.

Captures & Eliminates:

Particle Size in Microns				
100	10	1.0	0.5	0.3
		Spores		
		Pet Dander		
		Mold	Insecticide Dust	
Dust Mites/Dust Mite Debris			Bacteria	
	Pollen		Tobacco Smoke	
	Human Hair		Cooking Smoke/Grease	
		Household Dust		

Source: ASHRAE Standard 52.2-2007

Control Panel

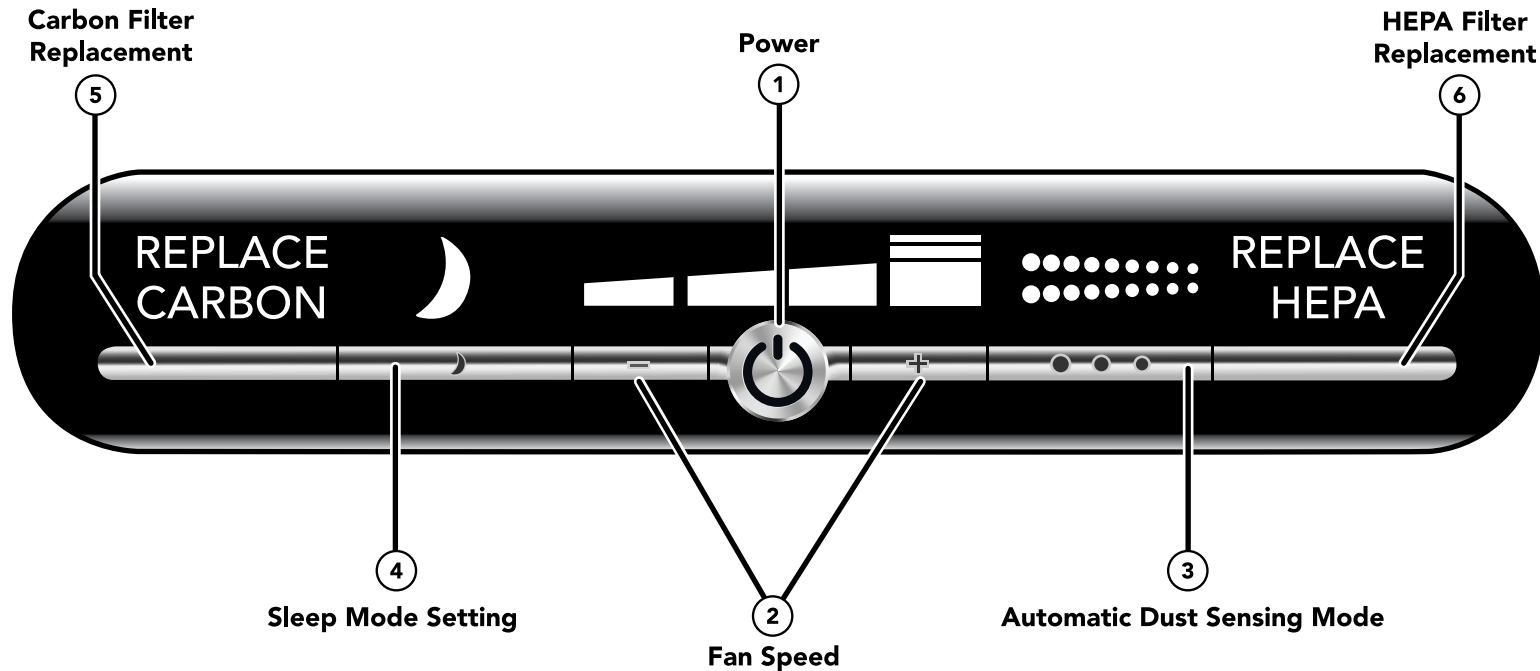

- ① **Power**, Function ON and OFF by pressing the Power button.
- ② **Fan Speed**, 4 fan speed settings. Adjust between Low, Medium, High and Quick Clean.
- ③ **Automatic Dust Sensing Mode**, Advanced technology that reads the amount of particles in the air and adjusts the fan speed accordingly. Refer to HOW TO USE to learn more about this feature.
- ④ **Sleep Mode Setting**, Senses no light or low light conditions, and automatically adjusts the unit to low speed. Refer to HOW TO USE to learn more about this feature.
- ⑤ **Carbon Filter Replacement**, Equipped with Replace Carbon filter indicator light to show when it is recommended to change the carbon filters.
- ⑥ **HEPA Filter Replacement**, Equipped with Replace HEPA filter indicator light to show when it is recommended to change the HEPA filters.

Automatic Light Dimming

After a short period of time, the control panel illumination will dim to not interfere with ambient environment lighting. Particularly ideal for darker rooms. Pressing any button will re-illuminate the control panel.

Fan Speed

Choose one of the 4 fan speed settings, press the “+” button to adjust to a higher speed or press the “-” button to adjust to a lower speed. The LED display will indicate the selected speed.

Note: Dust and allergens are most airborne when persons and pets are active in the room. For best results, set the unit on a higher speed setting during these times for high demand cleaning and circulation. Set the unit to a lower setting for quieter operation when activity is reduced.

Quick Clean Speed



A high-speed filtration setting can be used to rapidly filter the air when airborne particle levels are high. Press the (+) on the fan speed control until the Quick Clean icon (highlighted above) is displayed. You will immediately notice a dramatic increase in airflow that will allow the unit to provide maximum air filtration. Due to increased sound levels, use of this mode is recommended only as conditions require. Low, Medium and High speed settings are designed for day-to-day use.

How To Use

Automatic Dust Sensing Mode

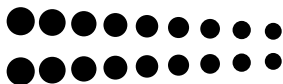

This feature monitors the air quality of the room to detect the presence of particles, then adjusts the fan speed to improve air quality to optimum conditions. Press the Automatic Dust Sensing Mode Button to engage this feature. The screen will display the animated Automatic Dust Sensing icon (shown above), to indicate when this feature is active. The Dust Sensor will continuously monitor the amount of airborne particles in the environment and adjust the fan speed between Low, Medium and High as needed to maintain optimum air quality. The Quick Clean speed is not utilized when Automatic Dust Sensing Mode is enabled. Please note that Automatic Dust Sensing Mode is overridden when Sleep Mode is engaged to ensure the unit is providing a consistent, low noise level during nighttime sleep.

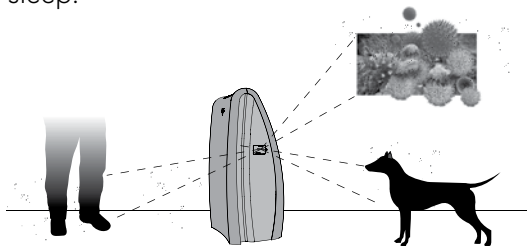

When To Use:

This feature allows the unit to reduce energy usage when fewer airborne contaminants are present in the room. Because active people and pets tend to stir up airborne particles, the unit will tend to increase speed during peak periods of activity in the room until lower readings are obtained. This feature is ideal for rooms where activity fluctuates greatly based on the time of day.

Note: The Dust Sensor will need to be cleaned periodically. Please refer to CLEANING AND MAINTENANCE on page 17.

Sleep Mode Setting



This feature senses no light or low light conditions, and automatically adjusts the unit to low speed. Press the Sleep Mode button to engage this feature. The Sleep Mode icon (shown above) will display. Ideal for use in bedrooms. Higher and more powerful speeds may be used throughout the day with lower speeds and minimal noise being preferable at night.

Note: When in low light or no light, with sleep mode selected, the unit will only operate at low speed. This will override Automatic Dust Sensing Mode and high-speed settings. In regular light, the unit will operate at the previous setting.

Carbon Filter Replacement

Equipped with Replace Carbon filter indicator light to show when it is recommended to change the carbon filters. Please refer to FILTER REPLACEMENT for instructions. This feature is controlled by time of use. The light will illuminate after 4,000 hours of run time has accumulated.

Hepa Filter Replacement

Equipped with Replace HEPA filter indicator light to show when it is recommended to change the HEPA filters. Please refer to FILTER REPLACEMENT for instructions. This feature is controlled by time of use. The light will illuminate after 9,000 hours of run time has accumulated.

REPLACE
CARBON

REPLACE
HEPA

Note: User environments will differ. The filter replacement time is based on average use situations, if you are using the air cleaner in a more demanding environment, you may need to change your filter more frequently. In less polluted environments the filter life may extend beyond the notification.

1. Keep retail carton to store unit when not in use.
2. Use the hand holds on either side of the unit for easy carrying.



3. For best results, position the front of the unit (side with logo) towards the center of the room, leaving at least a 6 inch distance away from walls or furniture on every side.

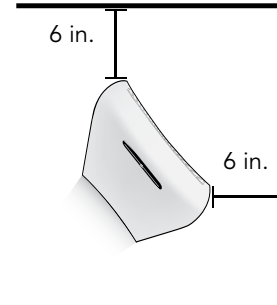

Note: For optimum airflow, air outlet should be unobstructed. Ensure curtains and other items are far enough away from the unit to not be pulled into the side inlets or interfere with airflow.

Filter Replacement

Genuine Vornado Filters Are Recommended

Peak performance is only realized when genuine Vornado Carbon and HEPA filters are used. Others may claim to be compatible with Vornado units, but the Vornado Air Purifier is calibrated to achieve a 99.97% capture rate of particles 0.3 microns or larger, only when used with Vornado Filters.

How To Replace Your Filters

1. Unplug unit.
2. Remove Front Panel by lifting up and away from unit.

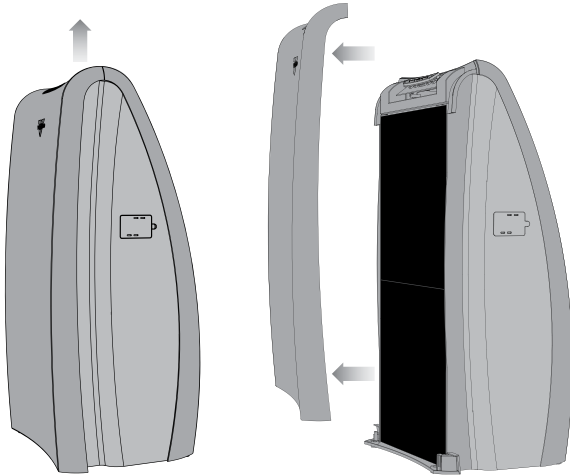

Note: The Front Panel is held in place by magnets, you will need to lift the Front Panel hard enough to overcome the resistance of the magnets.

3. Remove the Plastic Support Filter Frame by pulling on the center tabs (A). You may need to flex the Plastic Support Filter Frame slightly to release the tabs at the top and bottom.

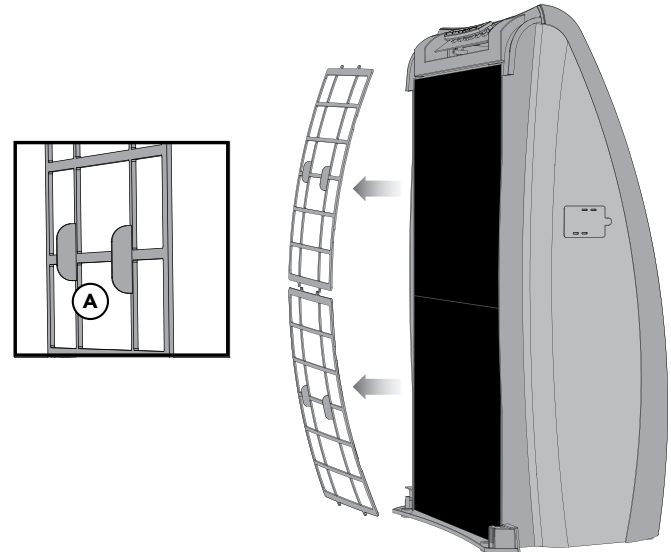

Filter Replacement

4. Remove and discard the Filters you wish to replace. To remove the Carbon Filter, take hold of the Filter at any place along the perimeter and remove. Repeat on the second Filter. To remove the HEPA Filter, after the Carbon Filters have been removed, take hold of the tab (Figure 1) and pull to release. Repeat on the second Filter. Replace with genuine Vornado Filters. Place the Filters in the unit and gently press around the perimeter of the Filter to ensure secure placement (Figure 2).

Note: The HEPA Filters must be placed in the unit before the Carbon Filters. See Product Information for a detailed illustration.

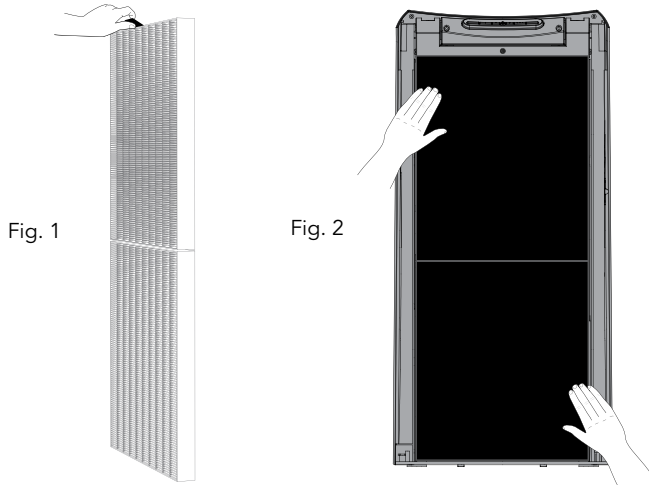

5. Replace the Plastic Support Filter Frame by securing the bottom 2 tabs into bottom slots (B). Slightly flex the Plastic Support Filter Frame to secure the top 2 tabs into the top slots (A).

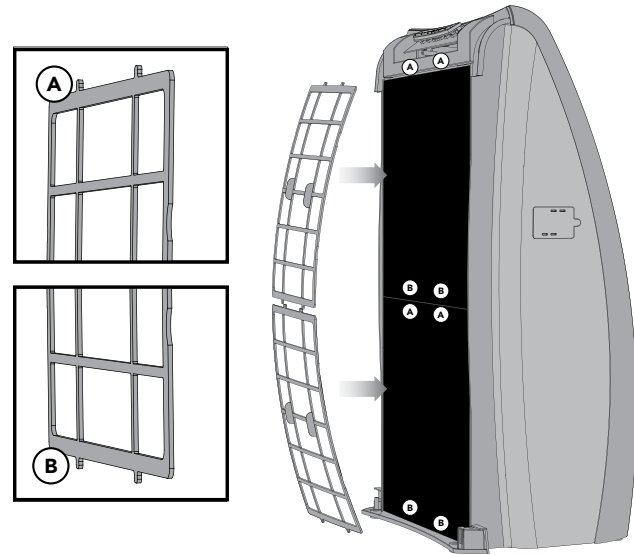

Filter Replacement

- Replace Front Panel by positioning the Panel slightly above the unit and aligning the tabs of the Front Panel with the holes in the unit (A). Gently press the Front Panel down, sliding into the tab slots and allowing the magnets to securely lock the Front Panel in place.

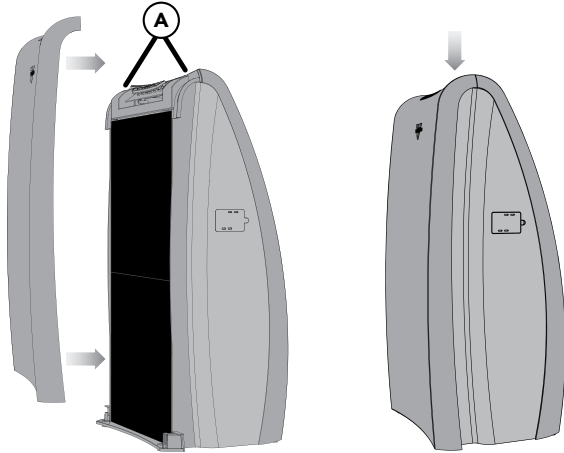

Safety Shut-Off Feature

For your protection, the unit is designed to operate only if the Front Panel is in place. Do not attempt to override this safety feature. If, after the Front Panel has been reinstalled, the unit does not operate, remove and reinstall the Front Panel to assure proper placement.

- To reset the Replace Filter notification - press and hold the REPLACE CARBON or REPLACE HEPA button, depending on which Filter was replaced, for at least 3 seconds. The light will turn off confirming the indicator is reset.

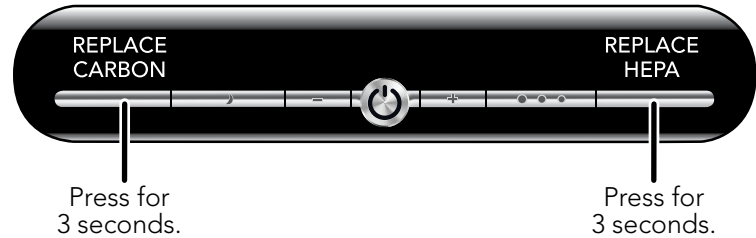

Note: Do not operate the Air Purifier without Vornado Carbon and Vornado HEPA Filters in place.

Storage

Follow the steps listed below when you are ready to store your unit.

- Unplug power cord and bundle loosely.
- Lift unit with both hands, using hand holds. (Refer to USER TIPS on page 13)
- Cover, or place back in retail carton if available. This will prevent the unit from accumulating dust overtime.
- Store unit in a cool and dry location.

Cleaning and Maintenance

How to Clean

Because large volumes of air pass through your Vornado Air Purifier each day, it will need regular cleaning.

1. Unplug the unit before cleaning.

Note: Do not use gasoline, thinners, solvents or other chemicals for cleaning.

2. Wipe down with a soft, damp cloth. (Figure 1)

3. Dust or vacuum the interior and along the sides. It is recommended to clean the interior when the Filters are changed. (Figure 2)

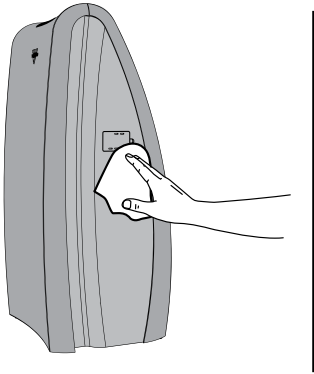

Fig. 1

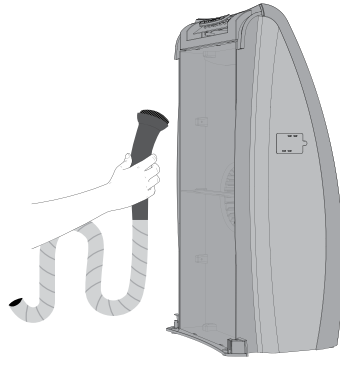

Fig. 2

Cleaning the Dust Sensor

It is recommended to clean the Dust Sensor when replacing the Carbon Filters.

1. Unplug the unit before cleaning.

2. Locate the Dust Sensor Access Door on the right side of the unit. (Figure 1)

3. Open Dust Sensor Access Door.

4. Gently wipe the surface of the Dust Sensor with a cotton swab. (Figure 2)

5. Once cleaned, close Dust Sensor Access Door.

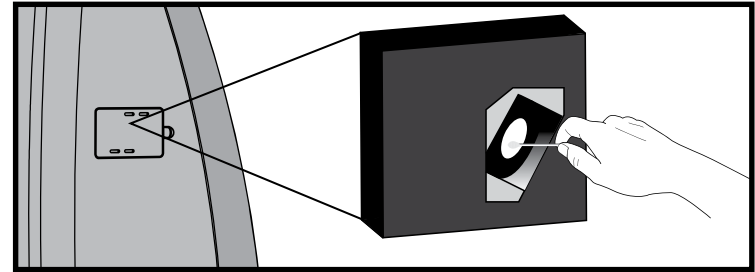

Fig. 1

Fig. 2

Other Maintenance

The motor is permanently lubricated so it needs no service. No other serviceable parts, other than Filters, are contained within the unit.

Troubleshooting

Problem	Possible Cause and Solution
Unit fails to power on.	<p>Unit is not plugged in. Plug power cord into electrical outlet.</p> <hr/> <p>Front Panel may not be properly installed. Remove and reinstall the Front Panel to assure proper placement. Refer to FILTER REPLACEMENT on page 16.</p> <hr/> <p>Household circuit breaker / ground fault interrupter has tripped or blown a fuse. Reset circuit breaker / ground fault interrupter, or replace fuse. For assistance, contact a licensed electrician.</p> <hr/> <p>Unit is damaged or in need of repair. Cease usage and unplug. Contact Consumer Service for assistance.</p>
Airflow is weak or slow.	<p>Unit set to a low speed setting. Adjust to a higher speed setting.</p> <hr/> <p>Debris build-up on filter. Check and replace Filters.</p> <hr/> <p>Airflow is blocked. Remove obstruction.</p>
Sleep Mode is not working.	<p>There may be too much light in the room. Either manually turn the unit to low speed for minimal sound or darken the room.</p>
Automatic Dust Sensing Mode is not working.	<p>Sleep Mode may be selected. When in low light or no light, the unit will only operate at low speed. This will override Automatic Dust Sensing Mode. In regular light, the unit will return to Automatic Dust Sensing Mode operation.</p> <hr/> <p>The Dust Sensor may need to be cleaned to accurately read dust levels. See CLEANING AND MAINTENANCE on page 17 for complete instructions.</p>



Whole Room Air Purifier • 5 Year Limited Warranty

Vornado Air LLC (“Vornado”) warrants to the original consumer or purchaser this Vornado® Air Purifier (“Product”) is free from defects in material or workmanship for a period of five (5) years from the date of purchase, depending on model. If any such defect is discovered within the warranty period, Vornado, at its discretion, will repair or replace the Product at no cost. Repairs not covered by the warranty or outside the warranty period will require a fee to cover the cost of materials, labor, handling and shipping.

This warranty does not apply to defects resulting from abuse of the Product, modification, alteration, repair or service of the Product by anyone other than Vornado, mishandling, improper maintenance, commercial use of the Product, damages which occur in shipment or are attributed to acts of God.

REPAIR OR REPLACEMENT AS PROVIDED UNDER THIS WARRANTY IS THE EXCLUSIVE REMEDY OF THE CONSUMER. VORNADO SHALL NOT BE LIABLE FOR ANY INCIDENTAL OR CONSEQUENTIAL DAMAGES FOR BREACH OF ANY EXPRESS OR IMPLIED WARRANTY ON THIS PRODUCT. EXCEPT TO THE EXTENT PROHIBITED BY APPLICABLE LAW, ANY IMPLIED WARRANTY OF MERCHANTABILITY OR FITNESS FOR A PARTICULAR PURPOSE ON THIS PRODUCT IS LIMITED IN DURATION TO THE DURATION OF THIS WARRANTY.

Some states do not allow the exclusion or limitation of incidental or consequential damages, or allow limitations on how long an implied warranty lasts, so the above limitations or exclusions may not apply to you. This warranty gives you specific legal rights, and you may have other rights that vary from state to state.

The manufacturer assumes no responsibility for damage or injury caused by failure to follow these instructions, improper product use, or unauthorized product modification. Any such actions will invalidate the product warranty.

For warranty or repair service, call 1-800-234-0604 or email consumerservice@vornado.com to obtain a Return Authorization (“RA”) form. Please have or include your Product’s model number and serial number, as well as your name, address, city, state, zip code and phone number when contacting Vornado for warranty service.

After receiving the RA form, ship your Product to:

Vornado Air LLC
Attn: Warranty & Repair
415 East 13th Street
Andover, KS 67002

For your convenience, please have your model number and serial number when contacting Vornado with service inquiries. To assure proper handling, packages must be clearly marked with the RA number. Packages not clearly marked with the RA number may be refused at the receiving dock. Please allow 1-2 weeks for repair and return of your Product after the Product is received. For your records: Staple or attach your original sales receipt to this Owner’s Guide. Please also write your products’s serial number below (located on product specs decal).

Serial No. _____

Product registration available online at www.vornado.com
© 2015 Vornado Air LLC Andover, KS 67002
Patents Pending. Specifications subject to change without notice.
Designed and Engineered in the U.S.A. Manufactured in China.
Vornado® is a trademark owned by Vornado Air LLC.
www.vornado.com consumerservice@vornado.com 800.234.0604



Vornado Air, LLC
415 East 13th Street, Andover, Kansas 67002
800.234.0604 | www.vornado.com

Speak your mind www.vornado.com/reviews