

Tools Required for Installation

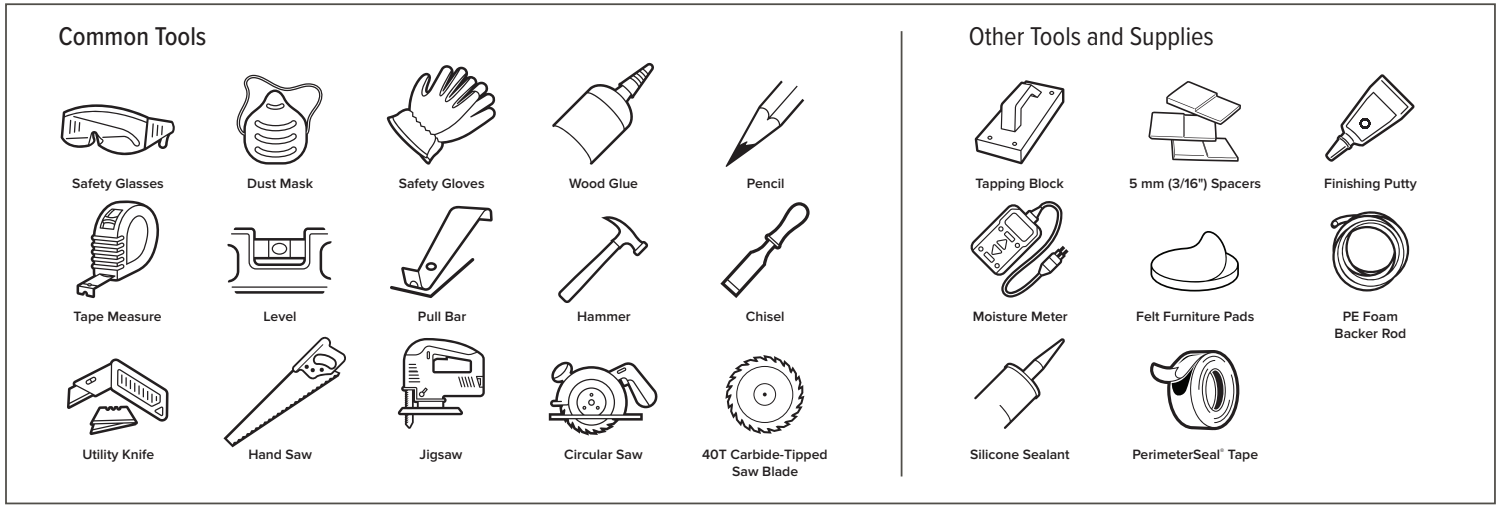

Jobsite

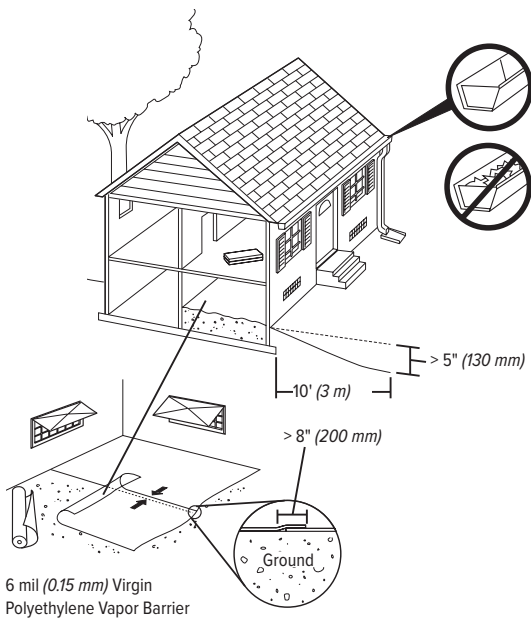

Site Requirements

This product is a durable floor covering, not intended as structural material. This product requires a clean, dry, secure subfloor that meets building codes.

The following requirements are not intended to supersede federal, state, or local building codes, but, as with many other interior finish products, may require modifying existing structural components for successful installation. Owner assumes responsibility for compliance with all building codes.

This product is suitable for use in climate-controlled (35%–65% RH and 60°F–85°F) indoor installations only and should not be installed over any floor with a sump pump or in a room with a floor drain. This product can be installed above, on, or below grade.

A moisture test is required to determine if high moisture exists in the subfloor.

Concrete subfloors must be tested in compliance with ASTM F2659, F1869, or F2170. Acceptable results at the TIME OF INSTALLATION must be recorded and documented and are as follows:

- ASTM F2659 – A meter calibrated for concrete qualified by gravimetric testing must be used. Moisture content must be $\leq 4.0\%$ MC.
- ASTM F1869 – Calcium chloride testing to determine water vapor emissions (MVER) ≤ 5 pounds / 24 hours / 1,000 square feet.
- ASTM F2170 – In-situ probe testing to confirm the Relative Humidity (RH) is $\leq 80\%$.

If any of these test results are outside of requirements, the flooring should not be installed until the concrete subfloor is within the proper range.

Wood subfloors must be tested and acceptable results at the TIME OF INSTALLATION must be recorded and documented and are as follows:

- A pinless (dielectric) or pin-type (electrical resistance) meter must be used to perform and record one moisture test per 100 square feet.
- Moisture content of wood subfloors must be $\leq 12\%$ MC.
- Variance between subfloor and laminate flooring may not exceed 4%.

If the moisture content of the subfloor and this flooring are outside of these tolerances, the flooring should not be installed until it is within the proper range. Acceptable jobsite conditions, including relative humidity and subfloor moisture conditions, must be maintained throughout the lifetime of the flooring.

This product is installed as a floating floor and requires the use of T-moldings in doorways less than 32 inches (0.81 m) or if the installation changes directions through the doorway (regardless of doorway size) and in rooms 50 feet (15.24 m) or larger in length or width. Floor movement must not be constrained by glue, nails, screws, hardware, or other fixed obstructions. This product must be installed in accordance with these installation instructions.

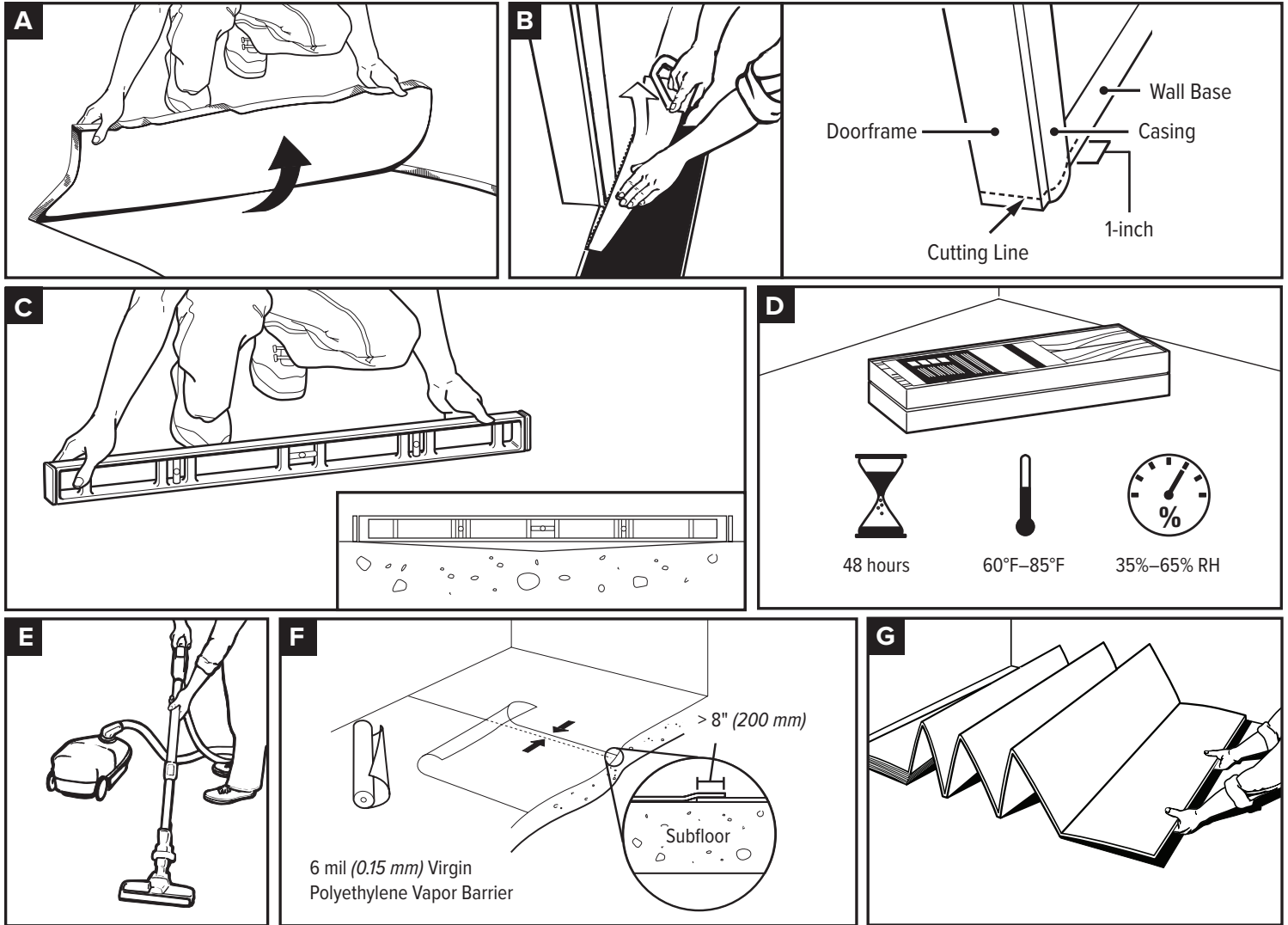

Site and Material Preparation

- A. Remove carpet and padding. Also remove any wood flooring installed on concrete. Do not remove products unless they are asbestos-free.
- B. Undercut doorframe and wall base. Slide the flooring at least 1/4 inch underneath the doorframe and wall base. Also leave a concealed 3/8-inch minimum expansion space under each.
- C. Remove bumps or peaks in subfloor and fill depressions with floor leveling compound to ensure no more than 3/16-inch unevenness per 10-foot span.
- D. If flooring is delivered at a moisture content and temperature that coincides with the expected in-use (e.g., normal living) conditions of the facility, and these conditions are maintained, no on-site acclimation is required. Otherwise, acclimate for 48 hours at 35%–65% RH and 60°F–85°F.
- E. Clean debris from subfloor before installation.
- F. For concrete subfloors, first install vapor barrier with overlapped seams of 8 inches or more.
- G. For planks without attached underlayment, install over single layer of underlayment appropriate for laminate floors. For planks with attached underlayment, it is acceptable to install Pergo FloorMate® underlayment prior to flooring installation if desired. Make sure to follow the Pergo FloorMate installation instructions, taking special care to seal all foam edges with sealing tape and repair all rips and perforations in the underlayment vapor barrier prior to flooring installation. A separate vapor barrier should not be used in conjunction with Pergo FloorMate.

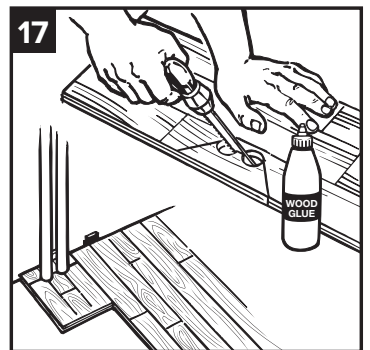
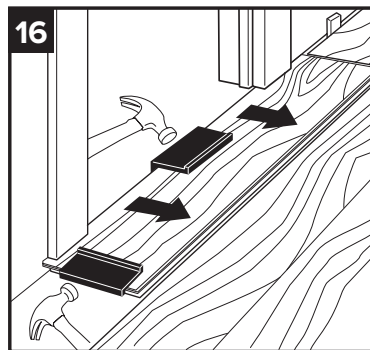
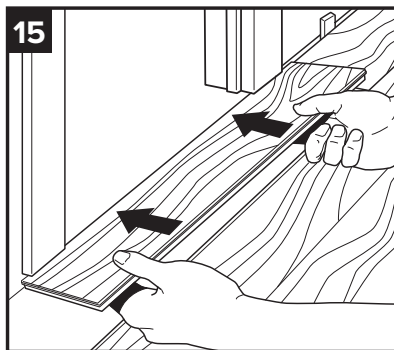
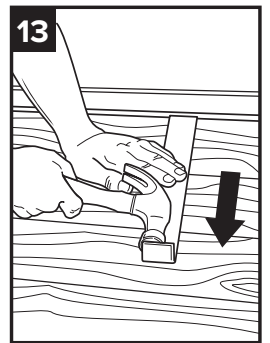
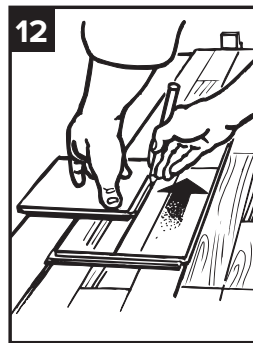
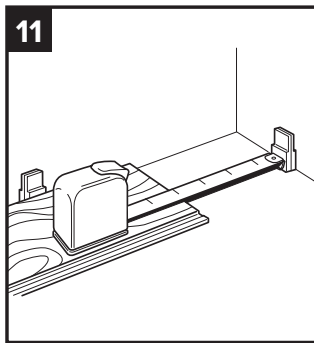
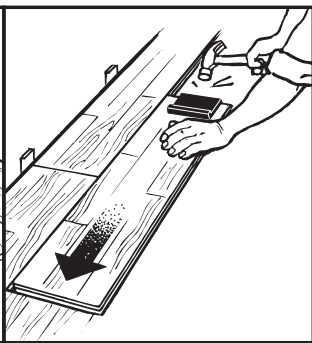
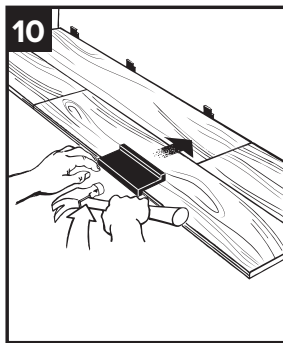
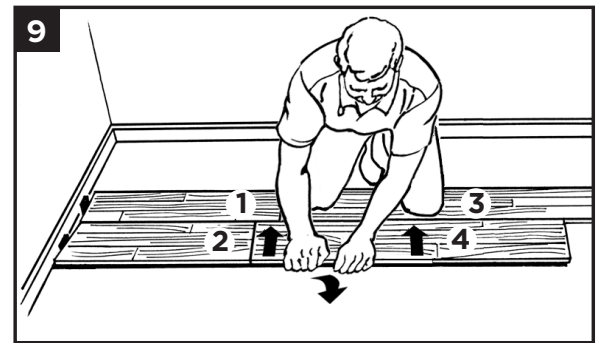
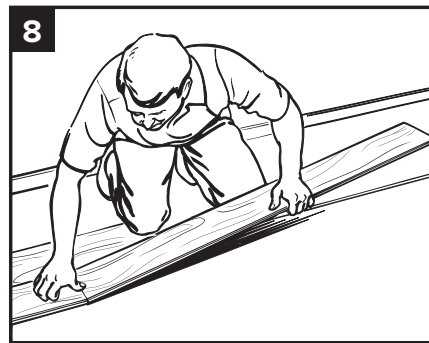
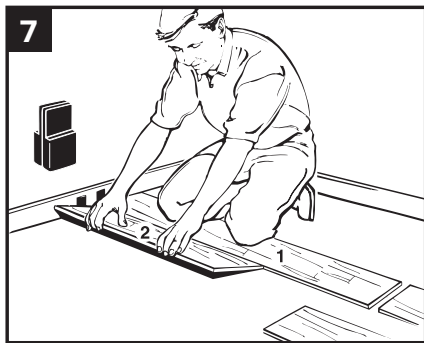
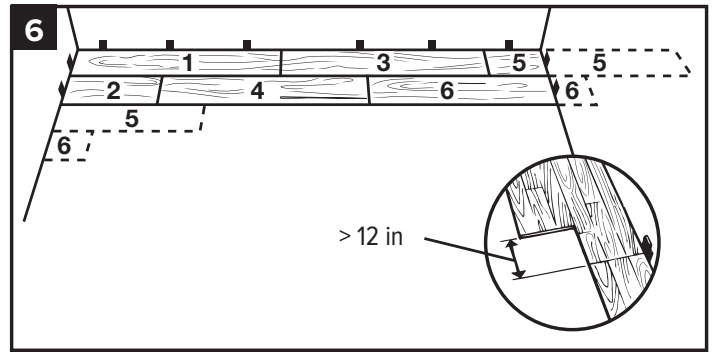
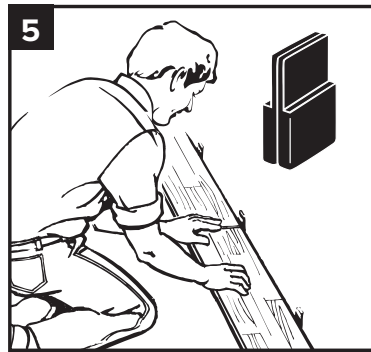
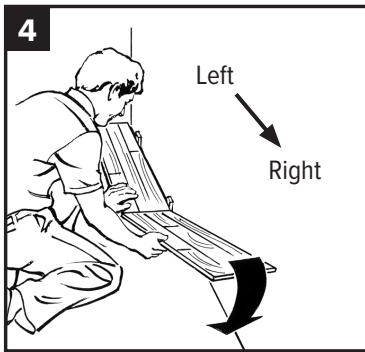
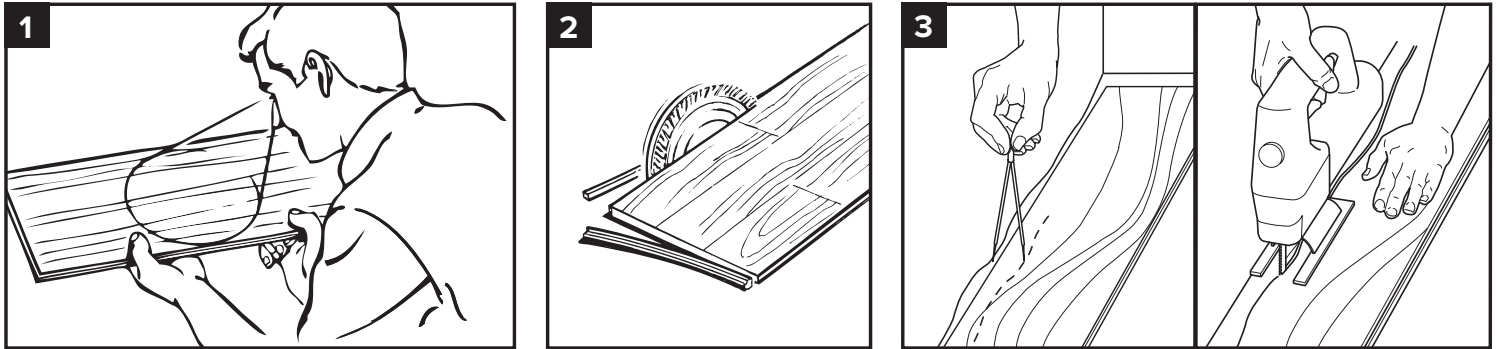

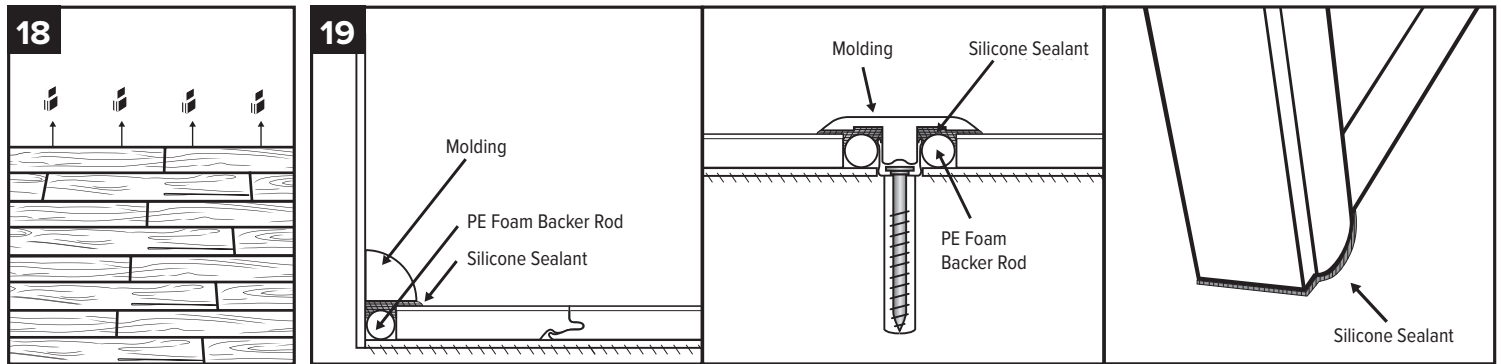

Flooring Installation

1. Inspect each plank. Floor should be installed by blending planks from several cartons at the same time to ensure good color and shade mixture throughout the installation.
2. For the first row along straight walls, remove the tongue on all long-side joints and on the short side of the first plank only.
3. For uneven walls, trace contour on the tongue side of plank and cut.
4. Assemble the first row, tongue side toward wall. Insert the end tongue into the end groove and rotate downward to assemble. Keep the planks aligned and the joints closed.
5. Two spacers thick side to thick side = 3/8 inch.
6. Provide a 3/8-inch space for expansion on all sides. First piece must be at least 8 inches long. Start new rows with pieces trimmed from previous row. Ensure at least a 12-inch end joint offset.
7. At a slight angle, insert the tongue of plank 2 into the groove of plank 1 until the plank edges meet, and then rotate down until the joints lock.
8. Join the short end of the plank first. There will be a gap on the long-side joints when the plank is rotated down.
9. Raise the outside edge of the plank, as well as the first plank in row 2, upward approximately 1 inch. Maintain this angle as you push the plank in until the plank edges meet. Rotate the plank downward until the joint locks. Repeat these steps to complete the installation.
 Installation Tip: Place a carton of planks across the end of the row being installed to keep installed planks in place during installation.
10. Alternate Tap Method: Align the tongues into the grooves of the long and short sides of the planks. Install the long side first by placing a tapping block no closer than 8 inches from either end and tap lightly along the long side until the joint is closed tightly. Then tap the end into a locked position using the tapping block. Note: Uneven tapping or use of excessive force may damage the joint.
11. Ensure there will be a 3/8-inch gap (after the joint is closed) between the plank and the wall for expansion.
12. For the last row, align the plank to be used on top of the second-to-last row. Using a full-width plank as a spacer, trace the wall contour and cut the plank.
13. For the last row, install the long-side tongue into the groove with the end joint aligned. Using a pull bar and hammer, work evenly along the length of the plank and lightly tap the joint closed.
14. After tapping the long-side joint closed, tap the short side closed using a tapping block or a pull bar.

Installation Under Doorway Casing

15. Slide plank under pre-cut door casing.
16. Tap the long-side joint closed first. Then tap the end joint closed.

Installation Around Fixed Objects (Such as Pipes)

17. Allow 3/8-inch expansion space around pipes or other fixed objects.

Finishing the Installation

18. Remove all spacers.

19. The entire perimeter of the installation must be sealed with 100% silicone sealant or PerimeterSeal® tape in accordance with the installaton instructions. For sections where the PerimeterSeal tape cannot be used, seal the perimeter with 100% silicone sealant as follows. **DO NOT** use acrylic sealant.
- First, fill all expansion spaces with 3/8-inch compressible PE foam backer rod and cover with silicone sealant.
 - Prior to installing the moldings, apply silicone sealant to the portion of the molding or transition that will contact directly with the flooring surface.
 - Install moldings and immediately wipe away any excess silicone sealant.
 - Apply silicone at connections to doorframes or any other fixed objects.

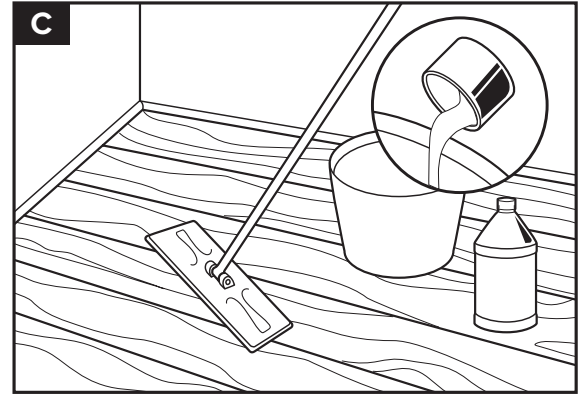
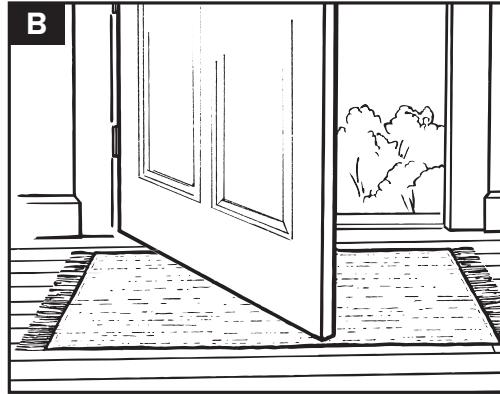

Care and Cleaning

- A. Place felt floor protectors under legs of moveable furniture. Chair casters should be rubber — not plastic or metal. Chair pads should be used under chair casters.
- B. Place walk-off mats at entrances.
- C. Dust mop as primary cleaning method. Occasionally damp mop with water only, using a well-wrung-out mop; **DO NOT** pour liquid directly on floor or use an excessively wet mop that will puddle or leave moisture standing on the floor. If needed, use a solution of 1 cup of vinegar per gallon of water OR 1/3 cup non-sudsing ammonia per gallon of water. **DO NOT** use detergents, abrasive cleaners, soaps, waxes, or polishes. Use correct hard surface vacuum tools. **DO NOT** use rotating beater bars, floor scrubbers, steamers, jet mops, or similar products. Wipe up spills immediately. **DO NOT** allow topical moisture to remain on the floor longer than the time specified in the product warranty.