

FunTime

Carnival Style

8oz Hot Oil Popcorn Machine

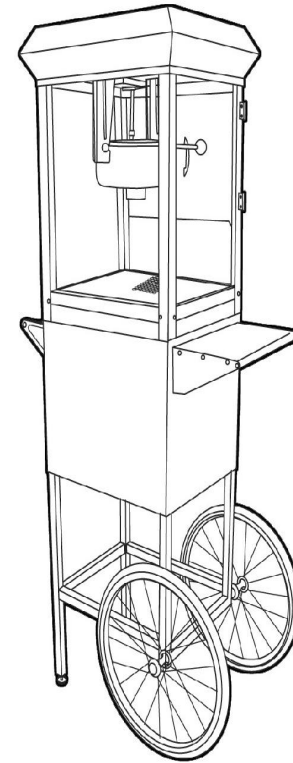

FT862CR/FT862CB
INSTRUCTION MANUAL
(FOR AC 120V/60HZ)

IMPORTANT SAFEGUARDS

When using any electrical appliance, basic safety precautions should always be followed, including the following:

1. **READ ALL INSTRUCTIONS BEFORE USING YOUR POPCORN MACHINE.**
2. Do not touch hot surfaces. Always use handles or knobs to operate.
3. To avoid any risk of electrical shock, do not immerse cord or plug into water or other liquid.
4. Close supervision is necessary when it is being used by or near children.
5. Unplug main power cord from outlet while not in use and before cleaning.
6. Allow HOT parts to cool down before maneuvering.
7. Do not operate the appliance with damaged cord or plug, malfunction or with any mechanical damages. Send the unit to the nearest authorized service center for examination and repairs. (ONLY technicians should open up the unit)
8. It may cause injury by using any accessories or attachments not being provided or recommended by manufacturer.
9. Do not pop the kernel with a dry pot (without oil).
10. Do not immerse kettle set into water.
11. Kettle surface is HOT and should NOT be touched during Popping or just after used.
12. Unplug, clean and cover the unit and store into dry and safe place if not being use for a long time.
13. Do not leave power cord hanging over edge of table or counter or touch with any hot surfaces.
14. Do not place the unit on or near a hot gas or electric burner or in a heated oven.
15. Extreme caution must be paid when moving the appliance containing hot oil or other hot liquids.
16. Turn ALL switches to "OFF" position before disconnecting power plug from the wall supply outlet.
17. Not recommended for outdoor use.
18. Do not use appliance for other than indicated usage.
19. To avoid overheating, always add oil and then kernel before operating.
20. Extreme caution must be paid when unloading popcorns. Always place the unit over a counter-top so that residual hot oil or water running out will not cause burnt.
21. KEEP OUT OF REACH OF CHILDREN.
22. DO NOT CLEAN USING ANY ABRASIVE MATERIAL.
23. NEVER FORCE ANY PARTS OR BRACKETS INTO POSITION.
24. NO PARTS ARE INTENDED FOR THE DISHWASHER.

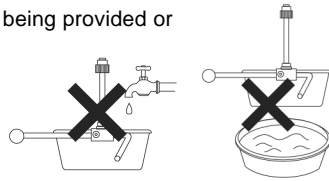

Assembling Parts

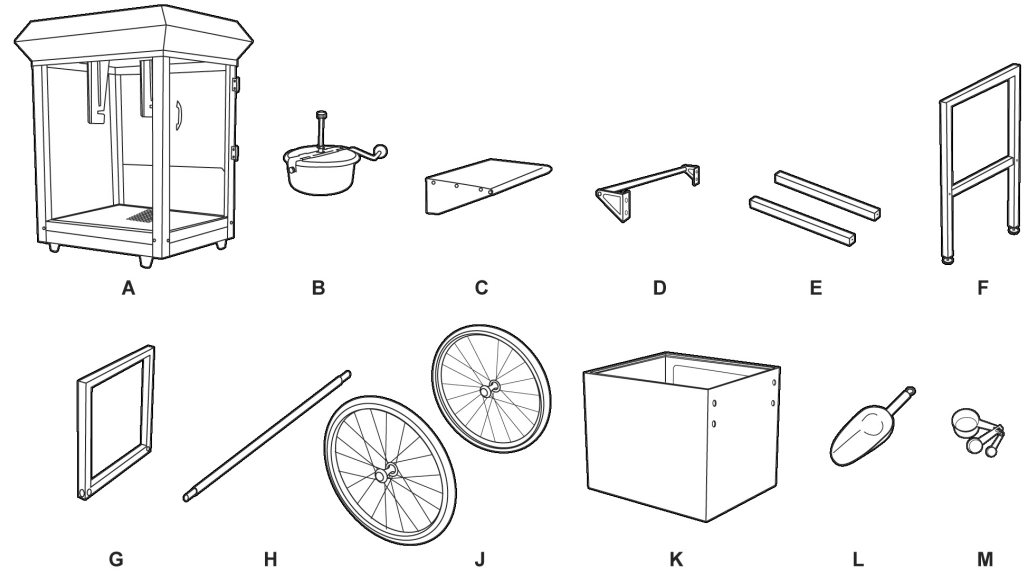

- | | |
|---|---------------------------------|
| A. Main unit x 1 pc | B. Kettle x 1 pc |
| C. Working platform x 1 pc | D. Hand rail x 1 pc |
| E. Square pole x 2 pcs | F. Long stand x 1 set |
| G. Short stand x 1 set | H. Wheel axle x 1 pc. |
| J. Wheels x 2 pcs. | K. Storage cabinet x 1 pc |
| L. Popcorn scoop x 1 pc | M. Kernel scoop + Oil scoop set |
| N. Parts x 1 box include: | |
| - (Package A) gold plated bolts x 8 pcs. + nuts x 8 pcs. + washers x 8 pcs. | |
| - (Package B) bolts x 8 pcs. + washers x 4 pcs., | |
| - (Package C) nuts with round cap x 2 pcs. + washers x 2 pcs. | |
| - (Package D) wrench x 2 pcs. | |

SAVE THESE INSTRUCTIONS FOR HOUSEHOLD USE ONLY

Assembling Parts

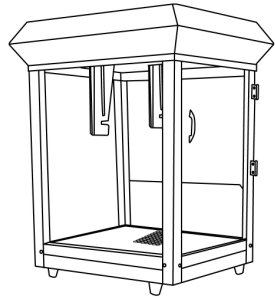

A



B



C



D

- A. Main unit x 1 pc
C. Popcorn scoop x 1 pc

- B. Kettle x 1 pc
D. Kernel scoop + Oil scoop set

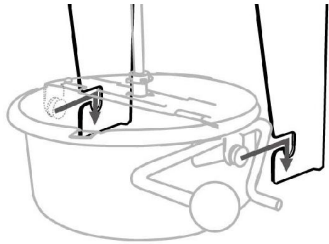

Assemble the kettle (B) on the supporters which are built into the main unit (A), and connect the socket.

FT862CR/FT862CB

Assembling Procedures:

1. Use bolts & washers (Package B) provided to connect the Long stand (F) and the 2 pcs square pole (E) together.
2. Connect the completed above (1) with the short stand (G) by the bolts & washers (Package B).
3. Insert axle (H) into short stand. Place sleeves and washers (Package C) onto each side of wheels (J) and then fix it with round cap nuts by wrenches provided (Package D).
4. Turn the storage cabinet (K) up side down for convenient assembling. Insert both ends of the short and long stand into the bottom of (H) and then fix by bolts in (Package B).
5. Turn the complete unit back to up-right position. Install the handrail (D) onto the left hand & the working platform (C) on the right hand by bolts & nuts with washers included in (Package A).
6. Place the main unit (A) onto the topside of the storage cabinet. (Caution: Power cord outlet should be inserted into the u-shape position.)
7. Hook up the Kettle (B) onto the hanger. (Caution: Roller bar should be on the door side and also check if gears between pot and ceiling are perfectly matched).
8. Connect the power plug from the ceiling with the socket on the bottom of the kettle.
9. Open the door of the storage cabinet and release the spring shaft beneath the main unit in order to fix the main unit with the storage base.

Remark: Main unit alone could be used and placed onto stable counter top for operation

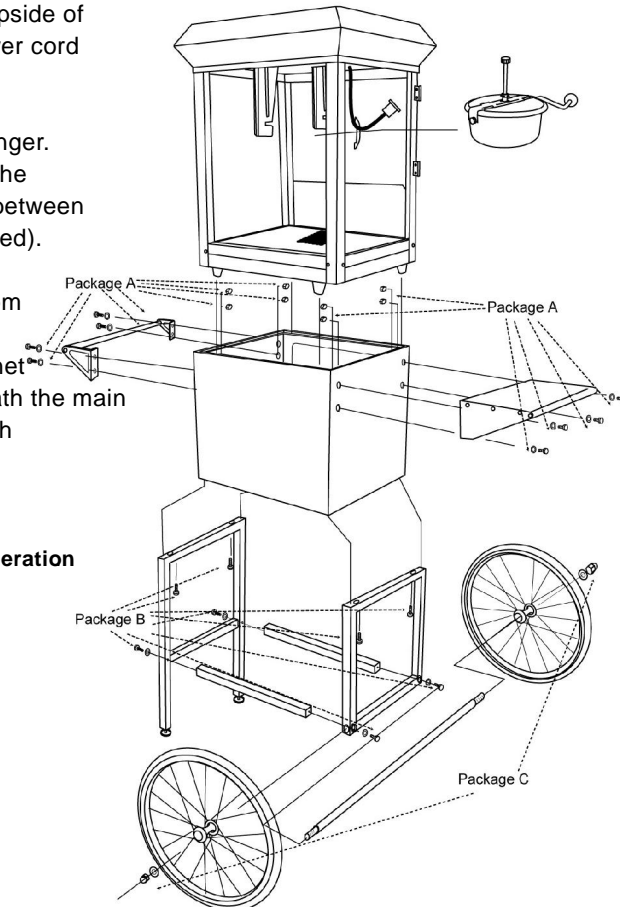

Operation Procedures:

User should follow these procedures:

- 1) Make sure the popcorn maker is unplugged before you do any of the following.
- 2) Before using the unit, please check carefully if voltage is suitable to the country. (Please check if the voltage is matching with rating label specified next to the power cord).
- 3) Clean the internal surface of the kettle and main unit surfaces.
- 4) Main unit has 3 function switches as follows:



Spot light and warmer (I)



Stirrer (II)



Stainless steel Kettle heater (III)

- 5) Hook up the kettle onto the hanger of the main unit.
- 6) Plug in the power cord to the popcorn maker.
- 7) Switch on the light and heater (I & III), and then fill in suitable amount of butter or oil (Fig. 1). Consumer could fill amount of oil (Max. 15g) subject to your own preference.
- 8) Kettle should be pre-heated for 3 to 4 minutes with oil (until steam comes out from the kettle). Please prepare kernels with sugar. (Measure amount of kernels by measuring scoop provided and amount of sugar subject to your own preference, liquid sugar and honey are prohibited to be used.)
- 9) Open the lid and then pour in pre-mixed kernel and sugar. (Fig. 2)
Caution: Lid might be hot and recommend using an oven mitten.
- 10) Switch ON the Stirrer (II) so that it starts stirring. (Fig. 3)
- 11) Close the door carefully.
- 12) Popcorn starts popping out through the lid after about 2 to 3 minutes. (Fig. 4)
- 13) Switch OFF the stirrer & heater (II & III) when popping completed (No more popping sound from kettle). Rotate the roller bar of the kettle and pour out all remaining popcorn from kettle.
- 14) Keep heater switch (III) OFF if the unit is not continuously running. Keep only the spot light and warmer ON to keep the popcorn warm, dry and tasty.
- 15) Serve your popcorn with popcorn scoop provided.
- 16) Remove plug from power supply if the unit is not being used for a long time.
- 17) Repeat steps 7 to 10 for continue popping.

Fig. 1

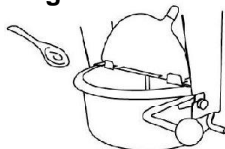

Fig. 2

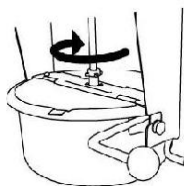
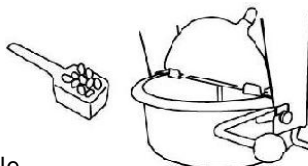
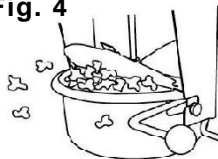

Fig. 4



Cleaning and Maintenance

To avoid burning excess amount of sugar from bottom of the inner pot, it is strongly recommended to clean the kettle after using 3 to 4 times.

After using the popcorn machine, users should use wet towel to clean up the main unit, main body and glasses; rubbish tray is strongly recommended to clean up frequently so that there is no bacteria.

Quick Cleaning Procedure:

Switch OFF (II & III). Pour 300 to 500 ml of water (NO detergent is necessary) into inner pot. Switch ON the stirrer (II) & heater (III) again to boil the water and let the stirrer to turn in order to remove excess amount of sugar stuck on the surface. Pour out the water after about 1 to 2 minutes of boiling. **Caution: Hot kettle!** Repeat the same procedure 2 to 3 times to get better result.

Standard cleaning procedure:

1. Repeat the above "Quick cleaning procedure" until it's relatively clean.
2. Switch off the machine and wait for the popping pot become cold. Clean the inside and outside of the kettle by brush and wet towel. (NEVER immerse the kettle into water.)

Spare part components



Housing
PC862 -105B/R



Block plate
PC862-109



Kettle
PC862-111

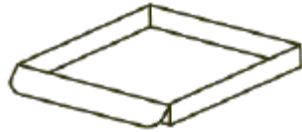

Crumb tray
PC862-110



Right plastic door
PC862-106R



Lamp holder
PC862-104



Left plastic door
PC862-106L



Upper gear housing
PC862-102



Lower gear housing
PC862-103



Side plastic panel
PC862-107

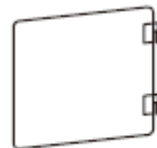

**Hot Buttered Popcorn 5C
Door w/ Hinge & handle
Red/Black**
PC862-120R/B



Back plastic panel
PC862-108

Trolley components

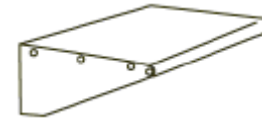

Working platform
PC862-112RG/BS



Short stand
PC862-116R/B

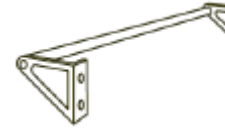

Handrail
PC862-113RG/BS

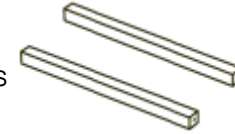

Square poles
PC862-114R/B



Wheels
PC862 -118RG/BS



Long stand
PC862-115R/B



Package B
PC-Package-B



Package C
PC-Package-C



Package A
PC-Package-A

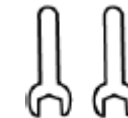

Package D
PC-Package-D



Measuring cup set
PC101B



Popcorn scoop
PC101A



Wheel Axle
PC862-117R/B

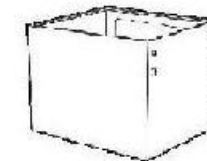

Square Storage Cabinet
PC862-119R/B