

HAMPTON BAY®

Item # 1003514226

Model # 65-7148B7 Tbl/65-7148B7

USE AND CARE GUIDE

CAMBRIDGE RECTANGLE DINING TABLE

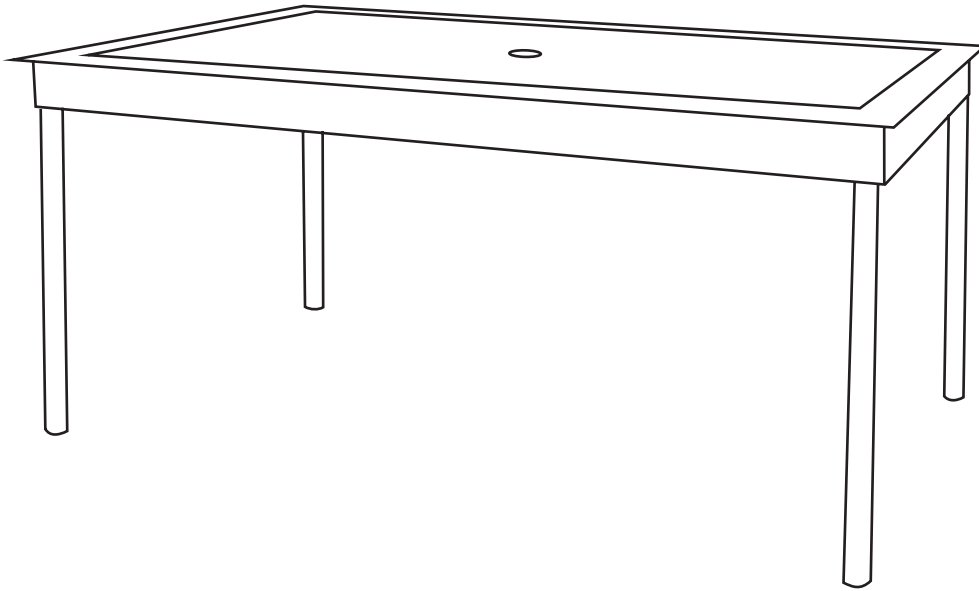

Questions, problems, missing parts? Before returning to the store,
call Hampton Bay Customer Service
8 a.m. - 7 p.m., EST, Monday – Friday, 9 a.m. – 6 p.m., EST, Saturday

1-855-HD-HAMPTON

HAMPTONBAY.COM

THANK YOU

We appreciate the trust and confidence you have placed in Hampton Bay through the purchase of this dining table. We strive to continually create quality products designed to enhance your home. Visit us online to see our full line of products available for your home improvement needs. Thank you for choosing Hampton Bay!

Table of Contents

Table of Contents	2	Pre-Installation	3
THD - TOC2	2	Planning Installation	3
Safety Information	2	Hardware Included	4
What is covered	3	Installation	5
What is not covered	3	Care & Cleaning	6
Warranty	3	Service Parts	7

Important Safety Instructions

SAVE THESE INSTRUCTIONS



WARNING: FUELS USED IN LIQUEFIED PROPANE GAS APPLIANCES, AND THE PRODUCTS OF COMBUSTION OF SUCH FUELS, CAN EXPOSE YOU TO CHEMICALS INCLUDING BENZENE, WHICH IS KNOWN TO THE STATE OF CALIFORNIA TO CAUSE CANCER AND CAUSE BIRTH DEFECTS OR OTHER REPRODUCTIVE HARM. For more information go to: www.P65Warnings.ca.gov.



WARNING: FUELS USED IN WOOD OR CHARCOAL BURNING APPLIANCES, AND THE PRODUCTS OF COMBUSTION OF SUCH FUELS, CAN EXPOSE YOU TO CHEMICALS INCLUDING CARBON BLACK, WHICH IS KNOWN TO THE STATE OF CALIFORNIA TO CAUSE CANCER, AND CARBON MONOXIDE, WHICH IS KNOWN TO THE STATE OF CALIFORNIA TO CAUSE BIRTH DEFECTS OR OTHER REPRODUCTIVE HARM. For more information go to: www.P65Warnings.ca.gov.

READ ALL INSTRUCTIONS BEFORE USE

To reduce the risk of injury to persons:

1. Close supervision is necessary when this furnishing is used by or near children, or disabled persons, if applicable.
2. Use this furnishing only for its intended use as described in these instructions. Do not use attachments not recommended by the manufacturer.
3. This table is not intended to support an umbrella. Umbrellas must have a suitable base or stand.

SET UP YOUR FURNITURE PROPERLY

1. Ensure that all parts are assembled properly and fully tightened as per the instructions.
2. When placing in the desired location, ensure that all legs are resting on the same surface.

EXAMINE YOUR FURNITURE

Examine occasionally to ensure that there are no loose parts. If loose parts are found, they must be re-tightened fully before additional use.

OBERVE WEIGHT LIMITS

The weight limits for the following products are listed below:

- | | |
|--|---|
| <input type="checkbox"/> Chair: 300 lbs | <input type="checkbox"/> Sofa: 700 lbs |
| <input type="checkbox"/> Swivel Chair: 300 lbs | <input type="checkbox"/> Rocking Chair: 300 lbs |
| <input type="checkbox"/> Loveseat: 500 lbs | <input type="checkbox"/> Chaise Lounge: 300 lbs |
| <input type="checkbox"/> Ottoman: 150 lbs | <input type="checkbox"/> Dining Table: 100 lbs |
| <input type="checkbox"/> Table: 50 lbs | <input type="checkbox"/> Dining Chair: 200 lbs |



CAUTION: If you overload your furniture, injuries can occur.

Warranty

TWO YEAR FRAME, WEAVE AND FABRIC LIMITED WARRANTY

WHAT IS COVERED

We warrant the frame, weave and fabric to be free of manufacturing defects to the original purchaser for two years. For glass table top we warrant 30 days from the date of purchase.

WHAT IS NOT COVERED

This warranty does not cover commercial use, hardware, acts of nature, fire, freezing and abusive use. In addition, purchased parts are not covered under this warranty.

We reserve the right to make substitutions with similar merchandise, if the model in question is no longer in production.

Contact the Customer Service Team at 1-855-HD-HAMPTON or visit www.Hamptonbay.com.

Pre-Installation

PLANNING INSTALLATION

To prevent damage, place all parts on a soft surface during assembly. Remove all protective caps before beginning assembly.

HARDWARE INCLUDED

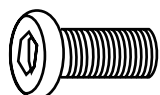

AA



BB

Part	Description	Quantity
AA	Bolt (ϕ 8 x16mm)	8
BB	Hex wrench (5mm)	1

PACKAGE CONTENTS

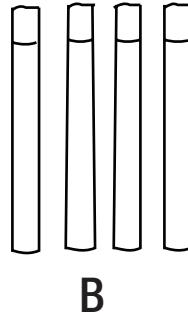
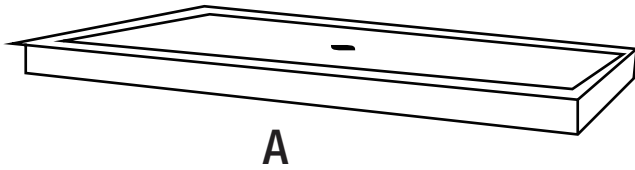

Part	Description	Quantity
A	Table top	1
B	Legs	4

Installation

1 Attaching the leg to the top

- Place the table top (A) on a soft surface.
- Place the metal side of the legs (B) into the four holes of top (A). The legs must be inserted as this image shown.
- Fasten with bolts (AA) and hand-tighten.

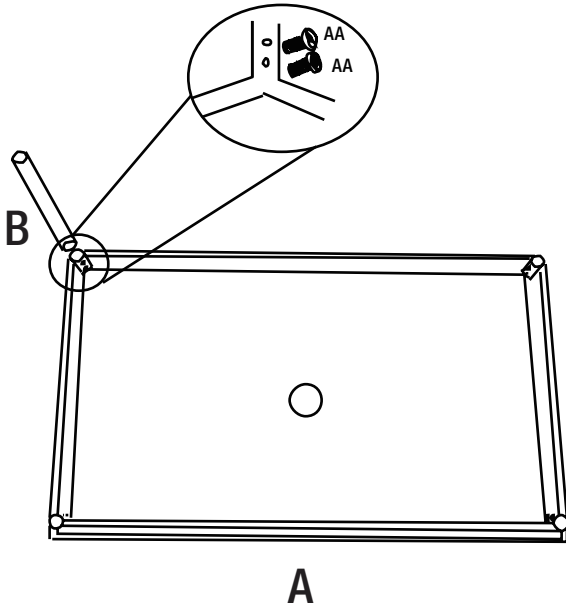

2 Attaching the other legs

- Repeat step 1 for the other legs.

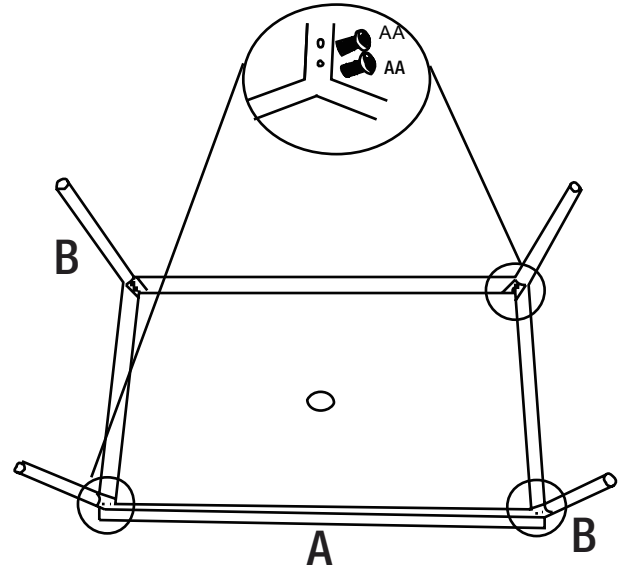

3 Completing the assembly

- Check and make adjustments as needed.
- Fully tighten all the bolts (AA) with the Hex wrench (BB).
- Place the table right side up.
- This table is now ready for your enjoyment.

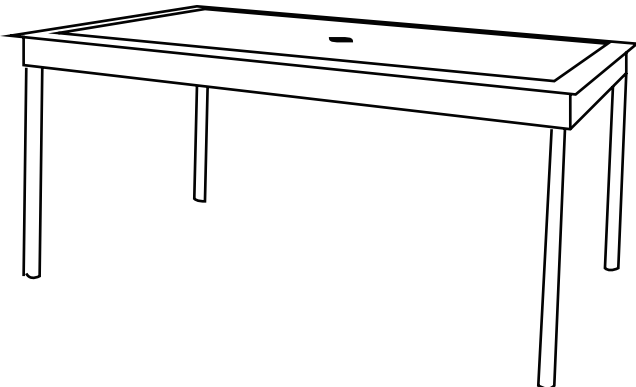

Care and Cleaning

- Before using, wipe with a clean, dry cloth. Do not use bleach or solvents. When not in use, store furniture in a cool, dry place. If your set includes cushions or mesh fabric, they may be cleaned by hand with a mild solution of soap and water.
- Rinse cushion thoroughly and allow to drip dry. Do not machine wash or tumble dry, as cushions may shrink.
- Do not use bleach or solvents on fabrics. When cleaning the table top make sure to use a soft, clean cloth that does not bleed color as well.

Care and Maintenance

- Wash the frame with a mild solution of soap and water, rinse with clean water, and dry thoroughly.
- Cushions may also be cleaned by hand with a mild solution of soap and water. Rinse the cushion cover thoroughly and allow to drip dry. The back cushion and pillow should be spot cleaned with a soft cloth. Do not machine wash or tumble dry, as cushions may shrink. Do not use bleach or solvents on fabrics. Never use cleaners that contain acid or abrasive materials.
- Use and operation: To improve the lifespan of this furniture, cover when not use and store in a dry place in the off season.

Service Parts

MODEL TYPE

Part	Description	Quantity
A	Table top	1
B	Legs	4

HAMPTON BAY®

Questions, problems, missing parts? Before returning to the store,
call Hampton Bay Customer Service
8 a.m. – 7 p.m., EST, Monday – Friday, 9 a.m. – 6 p.m., EST, Saturday

1-855-HD-HAMPTON

HAMPTONBAY.COM

Retain this manual for future use.