

HILTI

WSR 22-A

English

en



1 Information about the documentation



1.1 About this documentation

- Read this documentation before initial operation or use. This is a prerequisite for safe, trouble-free handling and use of the product.
- Observe the safety instructions and warnings in this documentation and on the product.
- Always keep the operating instructions with the product and make sure that the operating instructions are with the product when it is given to other persons.

1.2 Explanation of symbols used



1.2.1 Warnings

Warnings alert persons to hazards that may occur when handling or using the product. The following signal words are used in combination with a symbol:

	DANGER! Draws attention to an imminent hazard that will lead to serious personal injury or fatality.
	WARNING! Draws attention to a potential hazard that could lead to serious personal injury or fatality.
	CAUTION! Draws attention to a potentially dangerous situation that could lead to minor personal injury or material damage.





1.2.2 Symbols in the documentation

The following symbols are used in this document:

	Read the operating instructions before use
	Instructions for use and other useful information

1.2.3 Symbols in the illustrations



The following symbols are used in illustrations:

	These numbers refer to the corresponding illustrations found at the beginning of these operating instructions.
	The numbering reflects the sequence of operations shown in the illustrations and may deviate from the steps described in the text.
	Item reference numbers are used in the overview illustration and refer to the numbers used in the key in the product overview section.
	This symbol is intended to draw special attention to certain points when handling the product.

1.3 Product-dependent symbols

1.3.1 Symbols on the product

The following symbols are used on the product:

	Strokes per minute
	Stroke rate
	Direct current (DC)

1.4 Product information

Hilti products are designed for professional use and may be operated, serviced and maintained only by trained, authorized personnel. This personnel must be informed of any particular hazards that may be encountered. The product and its ancillary equipment may present hazards when used incorrectly by untrained personnel or when used not as directed.

The type designation and serial number are printed on the type identification plate.

- ▶ Write down the serial number in the table below. You will be required to state the product details when contacting Hilti Service or your local Hilti organization to inquire about the product.

Product information

Reciprocating saw	WSR 22-A
Generation:	01
Serial no.:	

2 Safety

2.1 General safety precautions for power tools

⚠ WARNING! Read all safety precautions and other instructions. Failure to observe the safety precautions and other instructions may result in electric shock, fire and/or serious injury. Keep all safety precautions and instructions for future reference.

Working area safety

- ▶ **Keep your working area clean and well lit.** Cluttered or dark working areas can cause accidents.
- ▶ **Do not operate the power tool in explosive atmospheres, such as in the presence of flammable liquids, gases or dust.** Power tools create sparks which may ignite the dust or fumes.
- ▶ **Keep bystanders, children and visitors away while operating the power tool.** Distractions may cause you to lose control of the tool.

Electrical safety

- ▶ **Do not expose the power tool to rain or wet conditions.** Water entering a power tool will increase the risk of electric shock.
- ▶ **Do not allow your body to come into contact with grounded surfaces such as pipes, radiators, ovens and refrigerators.** There is an increased risk of electric shock if your body is grounded.

Personal safety

- ▶ **Stay alert, watch what you are doing and use common sense when operating a power tool. Do not use a power tool while you are tired or under the influence of drugs, alcohol or medication.** A moment of inattention while operating the power tool may result in serious personal injury.
- ▶ **Adopt the correct posture when working. Maintain proper footing and balance at all times.** This will allow you to control the power tool better, even in unexpected situations.
- ▶ **Wear your personal protective equipment and always wear protective glasses.** Depending on the type of power tool you are using and its purpose, wearing safety equipment such as a dust mask, slip-resistant safety shoes, a hard hat or hearing protection will reduce the risk of injury.
- ▶ **Dress properly. Do not wear loose clothing or jewelry. Keep your hair, clothing and gloves away from moving parts.** Loose clothes, jewelry or long hair may be caught in moving parts.
- ▶ **Avoid starting the tool accidentally. Make sure that the power tool is switched off before connecting it to the battery and before picking it up or carrying it.** Carrying power tools with your finger on the switch or plugging in power tools that are already switched on may cause accidents.
- ▶ **Remove accessory tools or wrenches before switching the power tool on.** An accessory tool or a wrench left attached to a rotating part of the power tool may cause personal injury.
- ▶ **If devices are provided for connecting dust extraction and collection equipment, make sure these are connected and used correctly.** The use of a dust extraction system can reduce dust-related hazards.

Using and handling the power tool

- ▶ **Do not overload the tool. Use the correct power tool for your application.** The correct power tool will do the job better and more safely within the performance range for which it is designed.
- ▶ **Do not use a power tool if it has a faulty on/off switch.** Any power tool that cannot be controlled with the switch is dangerous and must be repaired.
- ▶ **Remove the battery from the power tool before making any adjustments, changing accessories or storing the tool.** This precaution reduces the risk of the power tool starting accidentally.
- ▶ **Store power tools out of reach of children when not in use. Do not allow persons who are not familiar with the tool or these instructions to operate it.** Power tools are dangerous in the hands of untrained users.
- ▶ **Maintain power tools properly. Check that moving parts are in correct working order and do not jam, and check whether any parts are broken or so damaged that correct operation of the power**

tool cannot be guaranteed. If any parts are damaged, have these parts repaired before using the tool. Many accidents are caused by poorly maintained power tools.

- ▶ **Keep cutting tools sharp and clean.** Properly maintained tools with sharp cutting edges are less likely to jam and are easier to control.

Using and handling the cordless power tool

- ▶ **Use only the specified batteries in the power tools.** Use of any other batteries may present a risk of injury and fire.
- ▶ **Recharge the batteries only with the chargers specified by the manufacturer.** A charger that is suitable for a certain type of battery may present a risk of fire when used with other types of battery.
- ▶ **When the battery is not in use, keep it away from other metal objects such as paper clips, coins, keys, nails, screws, or other small metal objects that could cause bridging between the terminals.** A short circuit between the battery terminals may cause burns or a fire.
- ▶ **Liquid may leak from the battery if used incorrectly. Avoid contact with this liquid.** Liquid leaking from the battery may cause skin irritation or burns. If contact accidentally occurs, rinse with water. Seek medical attention if the liquid comes into contact with the eyes.

2.2 Safety instructions for jig saws/reciprocating saws/band saws

- ▶ **Hold the power tool by the insulated gripping surfaces when carrying out work in which the accessory tool can come into contact with concealed wiring.** Metal parts of the power tool can also become live, resulting in electric shock, if contact is made with a live cable.

2.3 Additional safety instructions

Personal safety

- ▶ Use clamps or another practical way to secure and support the workpiece to a stable platform. Holding the work by hand or against your body leaves it unstable and may lead to loss of control.
- ▶ **Modification of the power tool is not permitted.**
- ▶ **Wear ear protectors.** Exposure to noise can cause hearing loss.
- ▶ **Respiratory protection must be worn if the power tool is used without a dust removal system for work that creates dust.**
- ▶ **Improve the blood circulation in your fingers by relaxing your hands and exercising your fingers during breaks between working.**
- ▶ **The power tool is not intended for use by inexperienced persons who have received no special training.**
- ▶ **Keep the power tool out of reach of children.**
- ▶ **Wear protective gloves when changing accessory tools as accessory tools get hot during use and cutting edges of saw blades are sharp.**
- ▶ **Switch the product on only after bringing it into the working position.**
- ▶ **Engage the transport lock before storing or transporting the tool.**
- ▶ Avoid unintentional starting. Never carry the power tool with your finger on the control switch. Remove the battery from the power tool during work breaks, before carrying out maintenance, before changing accessory tools and before transporting the power tool.
- ▶ **Observe the national health and safety requirements.**
- ▶ Dust from materials, such as paint containing lead, some wood species, concrete / masonry / stone containing silica, and minerals as well as metal, may be harmful. Contact with or inhalation of the dust may cause allergic reactions and/or respiratory or other diseases to the operator or bystanders. Certain kinds of dust are classified as carcinogenic such as oak and beech dust, especially in conjunction with additives for wood conditioning (chromate, wood preservative). Material containing asbestos may be handled only by specialists. **Use a dust removal system whenever possible. To achieve a high level of dust collection, use a suitable vacuum cleaner. When indicated, wear a respirator appropriate for the type of dust generated. Ensure that the workplace is well ventilated. Follow national requirements for the materials you want to work with.**

Electrical safety

- ▶ **Before beginning work, check the working area (e.g. using a metal detector) to ensure that no concealed electric cables or gas and water pipes are present.** External metal parts of the power tool may become live, for example, when an electric cable is damaged accidentally. This presents a serious risk of electric shock.

Special safety instructions for reciprocating saws

- ▶ **Always guide the power tool away from your body when working with it.**
- ▶ **Never position your hands ahead of or on the saw blade.**

- ▶ **Never cut into unknown materials and keep the line of cut above and below the workpiece free of obstacles.** If the saw blade strikes an object it may cause the power tool to kick back.
- ▶ **Apply moderate pressure and select a suitable stroke rate when using the pipe-cutting adapter (accessory), especially when cutting large-diameter pipes.** This will help to prevent the power tool overheating.
- ▶ **Warning! When cutting through pipes, e.g. when carrying out demolition or installation work, check to ensure that the pipes no longer contain liquids and empty them if necessary. When cutting through pipes, hold the power tool above the level of the pipe you are cutting through.** The power tool incorporates no protective measures to prevent ingress of water or dampness. Liquids running out of pipes may cause a short circuit in the power tool.
- ▶ **Do not attempt to cut material thicker than the specified max. thickness for which the saw is designed and do not use unsuitable saw blades (reciprocating saw blades of the wrong size or not equipped with a 1/2" connection end).**

Careful handling and use of batteries

- ▶ **Observe the special guidelines applicable to the transport, storage and use of lithium-ion batteries.**
- ▶ **Do not expose batteries to high temperatures and keep them away from fire.** There is a risk of explosion.
- ▶ **Avoid ingress of moisture.** Ingress of moisture may cause a short circuit, resulting in burning injuries or fire.
- ▶ **Do not disassemble, crush or incinerate batteries and do not subject them to temperatures over 80°C (176°F).** This presents a risk of fire, explosion or injury through contact with caustic substances.
- ▶ **Never continue to use or attempt to charge damaged batteries, e.g. batteries with cracks, broken parts, bent or pushed-in / pulled-out contacts).**
- ▶ **Do not use the battery as a power source for other unspecified power tools or appliances.**
- ▶ **If the battery is too hot to hold, it may be defective. In this case, place the power tool in a non-flammable location, well away from flammable materials, where it can be kept under observation and allowed to cool down. Contact HiltiService after the battery has cooled down.**

3 Description

3.1 Overview of the product

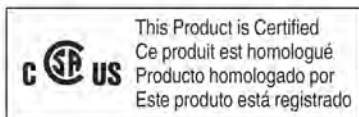
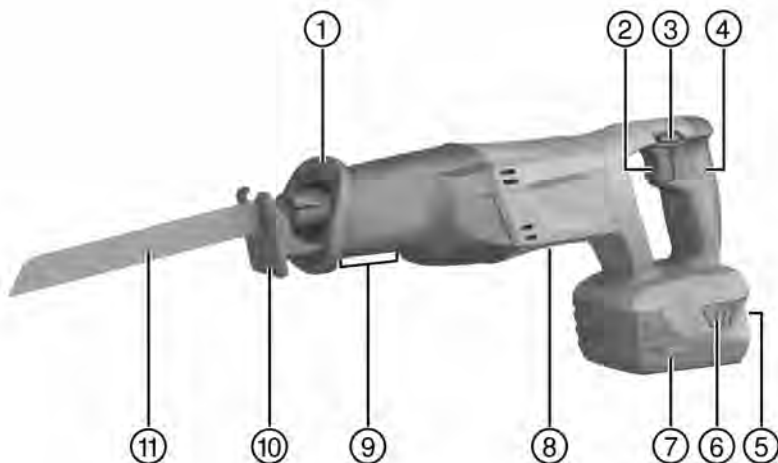

- | | |
|---------------------------------|--------------------------------------|
| ① Chuck (blade holder) | ⑦ Battery |
| ② Control switch | ⑧ Rating plate |
| ③ Safety lock | ⑨ Forward gripping area (hand guard) |
| ④ Grip | ⑩ AVR contact shoe |
| ⑤ Battery charge status display | ⑪ Saw blade |
| ⑥ Battery release button | |

3.2 Intended use

The product described is a cordless reciprocating saw. It is designed for cutting wood, wood-like materials, metals and plastics.

The product is designed for two-handed operation.

- ▶ Use only **Hilti** lithium-ion batteries of the B 18 / B 22 series with this product.
- ▶ Use only **Hilti** battery chargers of the C4/36 series with these batteries.

3.3 Possible misuse

- ▶ Do not use the power tool to cut bricks, concrete, cellular concrete, natural stone or tiles.
- ▶ Do not use the product to cut pipes that still contain liquids.
- ▶ Do not saw into unknown materials.

3.4 Lithium-ion battery status display

The charge status of the Li-ion battery and malfunctions of the power tool are indicated by the display on the Li-ion battery. The charge status of the Li-ion battery is displayed after pressing one of the two battery release buttons.

Status	Meaning
4 LEDs light up.	• Charge status: 75 % to 100 %
3 LEDs light up.	• Charge status: 50 % to 75 %
2 LEDs light up.	• Charge status: 25 % to 50 %
1 LED lights.	• Charge status: 10 % to 25 %
1 LED blinks.	• Charge status: < 10 %
1 LED blinks, the power tool is not ready for use.	• The battery has overheated or is completely discharged.
4 LEDs blink, the power tool is not ready for use.	• The power tool is overloaded or has overheated.



Note

Battery charge status cannot be displayed while the control switch is pressed and for up to 5 seconds after releasing the control switch. If the battery display LEDs blink, please observe the instructions given in the Troubleshooting section.

3.5 Items supplied

Reciprocating saw, operating instructions.



Note

To help ensure safe and reliable operation, use only genuine Hilti spare parts and consumables. Spare parts, consumables and accessories approved by Hilti for use with the product can be found at your local **Hilti** Center or online at: www.hilti.com

4 Technical data

4.1 Reciprocating saw

	WSR 22-A
Rated voltage	21.6 V
Weight	8.4 lb (3.8 kg)

	WSR 22-A
Stroke rate	0 /min ...3,000 /min
Stroke	1.1 in (28 mm)
Keyless chuck for standard accessory tools	1/2 in

5 Operation

5.1 Safe operation



CAUTION

Risk of injury! Inadvertent starting of the product.

- ▶ Remove the battery before making any adjustments to the power tool or before changing accessories.



WARNING

Risk of injury! Risk of kickback.

- ▶ Always use saw blades of adequate length. The end of the saw blade must always project beyond the workpiece over the entire blade stroke.



WARNING

Risk of injury! Caused by the chuck / accessory tool retaining mechanism

- ▶ Always hold the power tool securely with both hands on the grips provided. Never use the power tool without a fully functional hand guard.



Note

The power tool must be pressed against the workpiece until the AVR contact shoe makes firm contact. This helps ensure maximum safety and good performance.

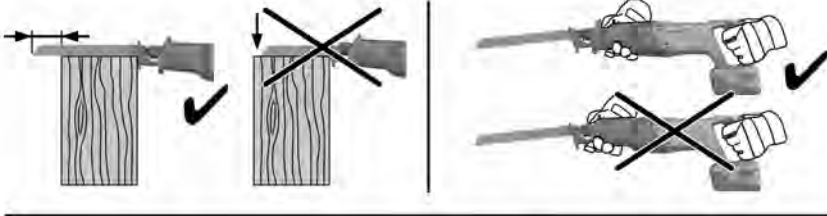

- ▶ Pull the battery out of the product to the rear.

5.2 Removing the battery



1. Press the two release buttons and hold them in the pressed position.
2. Pull the battery out of the product to the rear.

5.3 Fitting the saw blade



Note

Use only saw blades equipped with a 1/2" connection end.

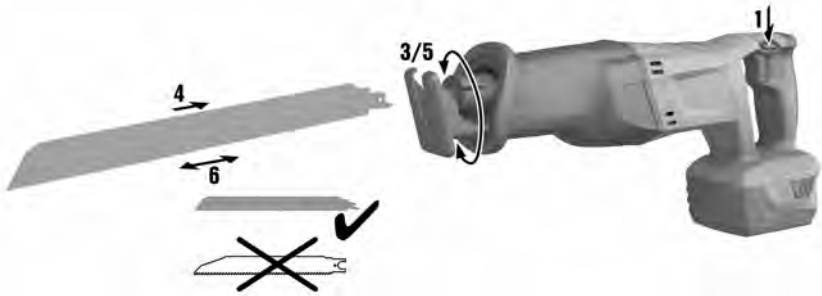

1. Engage the transport lock.
2. Check that the connection end of the accessory tool is clean and lightly greased. Clean it and grease it if necessary.
3. Turn the chuck locking sleeve counterclockwise and hold it in this position.
4. Push the saw blade into the chuck from the front end of the tool.
5. Release the locking sleeve and allow it to click back and engage in its original position.
6. Grip and pull the saw blade to check that it is locked in position.

5.4 Removing the saw blade

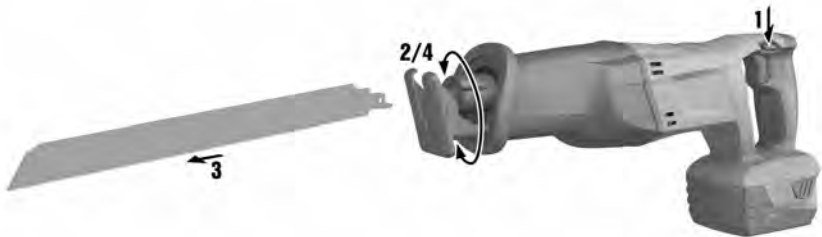

1. Engage the transport lock.
2. Turn the chuck locking sleeve counterclockwise and hold in this position.
3. Pull the blade forward out of the chuck.
4. Release the locking sleeve and allow it to move back to its original position.

5.5 Inserting the battery



WARNING

Electrical hazard! Risk of short circuiting.

- ▶ Before inserting the battery, check to ensure that the battery terminals and the contacts on the reciprocating saw are free from foreign objects.



WARNING

Risk of injury! Hazard presented by a falling battery.

- ▶ A falling battery may present a risk of injury to yourself and others. Check that the battery is securely seated in the reciprocating saw.



- ▶ Push the battery into the product from the rear as far as it will go and until it is heard to engage with a double click.

5.6 Switching on

1. Disengage the transport lock.
2. Press the control switch.

5.7 Switching off



WARNING

Risk of injury! Caused by the saw continuing to run.

- ▶ Do not lift the product away from the workpiece until it has stopped completely.
- ▶ Wait until the product stops completely before you lay it down.

1. Release the control switch.
2. Engage the transport lock.

5.8 Plunge cutting



WARNING

Risk of injury! Risk of kickback.

- ▶ Apply the appropriate safety measures at the rear of the workpiece when plunge sawing. Use only suitable saw blades (length as short as possible).



Note

Use the plunge cutting technique only on soft materials and with short saw blades. The product can be used in one of two plunge cutting positions: in the normal position or in the reversed position.

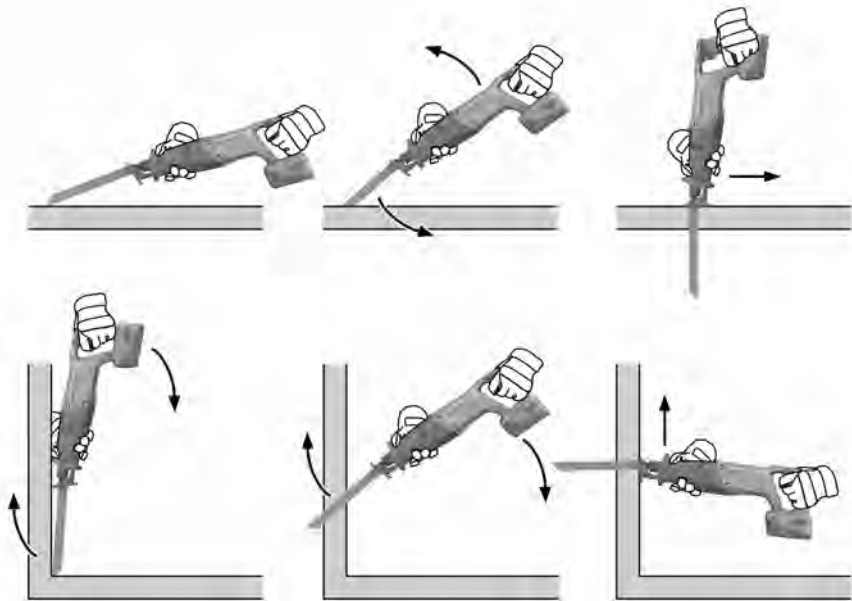

1. Bring the forward edge of the AVR contact shoe into contact with the workpiece.
2. Disengage the transport lock.
3. Press the control switch.
4. Press the forward edge of the contact shoe against the workpiece and begin the plunge action by slowly increasing the angle of attack.



Note

To prevent stalling, it is important that the product is running before the saw blade is brought into contact with the surface.

5. Once the saw blade has penetrated right through the material, bring the product into the normal working position (AVR contact shoe flush with the workpiece) and then continue sawing along the cutting line.

5.9 Changing the AVR contact shoe



Note

The AVR contact shoe can be changed when required.

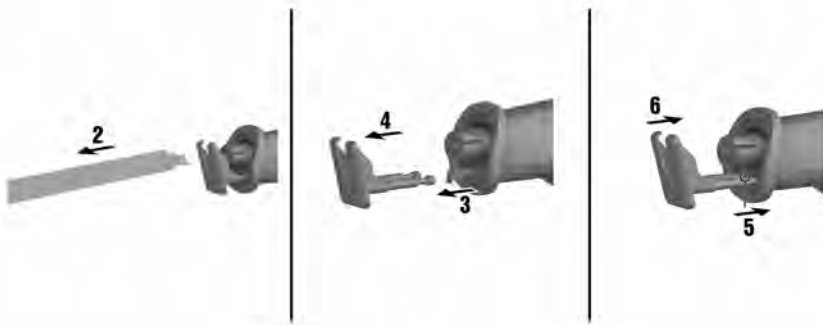

1. Engage the transport lock.
2. Remove the saw blade.
3. Pull the rectangular plastic pin forward.



Note

It is located between the two AVR contact shoe guide pins.

4. Pull the AVR contact shoe out.
5. Press the rectangular plastic pin back into the original position.
6. Grease the AVR contact shoe lightly and insert it fully in the guides.
7. Check that the contact shoe has engaged.

6 Care, maintenance, transport and storage

6.1 Care and maintenance of cordless tools



WARNING

Danger of electric shock! Carrying out care and maintenance while the battery is fitted presents a risk of serious physical injury and burning injury.

- ▶ Always remove the battery before carrying out all care and maintenance tasks.

Care and maintenance of the tool

- Carefully remove any dirt that may be adhering to parts.
- Clean the air vents carefully with a dry brush.
- Use only a slightly damp cloth to clean the casing. Do not use cleaning agents containing silicone as these may attack the plastic parts.

Care of the lithium-ion batteries

- Keep the battery free from oil and grease.
- Use only a slightly damp cloth to clean the casing. Do not use cleaning agents containing silicone as these may attack the plastic parts.
- Avoid ingress of moisture.

Maintenance

- Check all visible parts and controls for signs of damage at regular intervals and make sure that they all function correctly.
- Do not operate the cordless tool if signs of damage are found or if parts malfunction. Have the tool repaired by **Hilti** Service immediately.
- After cleaning and maintenance, fit all guards or protective devices and check that they function correctly.



Note

To help ensure safe and reliable operation, use only genuine Hilti spare parts and consumables. Spare parts, consumables and accessories approved by Hilti for use with the product can be found at your local **Hilti** Center or online at: www.hilti.com

6.2 Transport and storage of cordless tools

Transport



CAUTION

Inadvertent starting during transport. Uncontrolled starting during transport may occur if the battery is fitted, thereby resulting in damage to the tool.

- ▶ Always remove the battery before transporting the tool.

- ▶ Remove the battery.
- ▶ Transport the tool and batteries individually packaged.
- ▶ Never transport batteries in bulk form (loose, unprotected).
- ▶ Check the tool and batteries for damage before use after long periods of transport.

Storage



CAUTION

Inadvertent damage caused by defective battery. A leaking battery may damage the tool.

- ▶ Always remove the battery before storing the tool.

- ▶ Store the tool and batteries in a place that is as cool and dry as possible.
- ▶ Never store batteries in direct sunlight, on heating units or behind a window pane.
- ▶ Store the tool and batteries in a place where they cannot be accessed by children or unauthorized persons.
- ▶ Check the tool and batteries for damage before use after long periods of storage.

6.3 Checks after care and maintenance work

- ▶ After carrying out care and maintenance, check that all protective and safety devices are fitted and that they function faultlessly.

7 Troubleshooting

- ▶ If the trouble you are experiencing is not listed in this table or you are unable to remedy the problem by yourself, please contact **Hilti Service**.

7.1 The reciprocating saw is not operational.

Malfunction	Possible cause	Action to be taken
The LEDs indicate nothing.	The battery is not fully inserted.	▶ Push the battery in until it engages with a double click.
	The battery is empty.	▶ Charge the battery.
	The transport lock is engaged.	▶ Disengage the transport lock.
1 LED blinks.	The battery is discharged.	▶ Change the battery and charge the empty battery.
	The battery is too hot or too cold.	▶ Bring the battery to the recommended working temperature.

7.2 The reciprocating saw is operational.

Trouble or fault	Possible cause	Action to be taken
The tool does not achieve full power.	The control switch is not fully pressed.	▶ Press the control switch fully.
	The battery is discharged.	▶ Change the battery and charge the empty battery.
The saw blade can't be removed from the chuck.	The locking sleeve is not turned as far as it will go.	▶ Turn the locking sleeve as far as it will go and remove the saw blade.

8 Disposal



WARNING

Risk of injury. Hazards presented by improper disposal.

- ▶ Improper disposal of the equipment may have the following consequences: The burning of plastic components generates toxic fumes which may present a health hazard. Batteries may explode if damaged or exposed to very high temperatures, causing poisoning, burns, acid burns or environmental pollution. Careless disposal may permit unauthorized and improper use of the equipment. This may result in serious personal injury, injury to third parties and pollution of the environment.
- ▶ Dispose of defective batteries right away. Keep them out of reach of children. Do not disassemble or incinerate the batteries.
- ▶ Batteries that have reached the end of their life must be disposed of in accordance with national regulations or returned to **Hilti**.

 Most of the materials from which **Hilti** tools and appliances are manufactured can be recycled. The materials must be correctly separated before they can be recycled. In many countries, your old tools, machines or appliances can be returned to **Hilti** for recycling. Ask **Hilti** Service or your Hilti representative for further information.

9 Manufacturer's warranty

- ▶ Please contact your local **Hilti** representative if you have questions about the warranty conditions.

HILTI

Hilti Corporation

LI-9494 Schaan

Tel.: +423/234 21 11

Fax: +423/234 29 65

www.hilti.com

Hilti = registered trademark of Hilti Corp., Schaan
20160714

