

## User manual

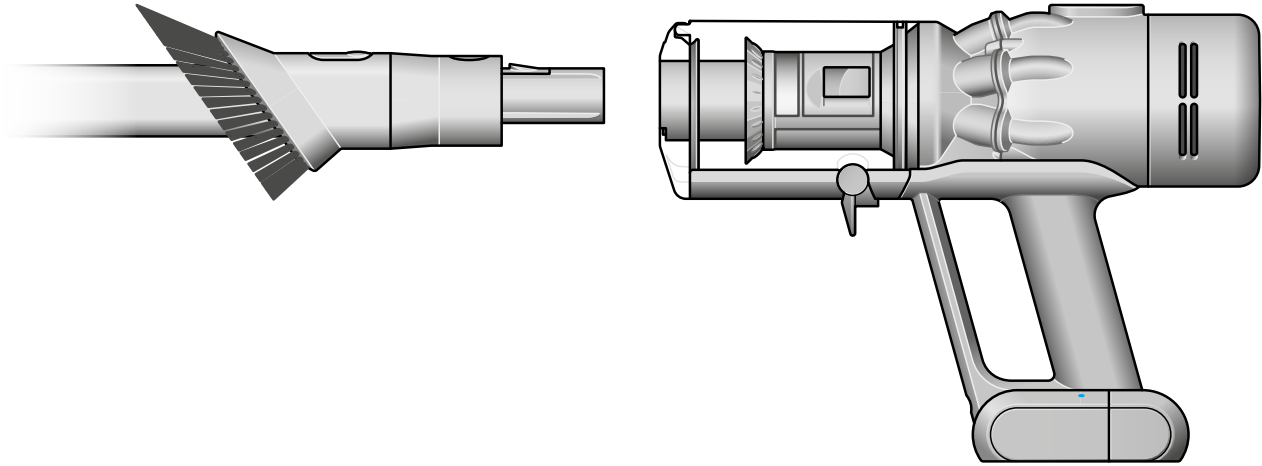

---

### Contents

In the box

Getting started

Charging your machine

Emptying your bin

Cleaning your bin

Washing your filter

Clearing blockages

Clearing blockages from your

Hair screw tool

Cleaning your tools

Looking after your machine

# In the box

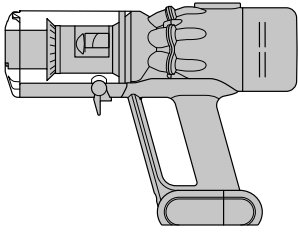

Main body showing the handle and bin attached.

**Vacuum cleaner**



The charger is a one piece unit with the plug, connector end and cable.

**Charger**

Charges your vacuum with or without a dock.

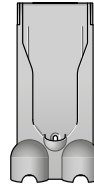

A rectangular dock that needs to be fixed to a wall with screws.

**Wall dock**

The Dyson cordless vacuum drops into the wall-mounted charging dock, ready for your next clean.

---

Some tools may not be included.

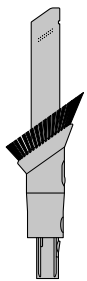

This tool has a combination of brush head and crevice tool together in one unit. The brush head slides down the crevice tool when needed.

**Combi-crevice tool**

Two tools in one – narrow nozzle and brush, for quick switching between cleaning and dusting tasks.

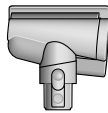

A small cleaner head with an angled body housing the motor and an electrical connector to attach to the wand or directly to the machine.

**Hair screw tool**

Anti-tangle conical brush bar spirals hair off and into the bin. Motor-driven cleaning for smaller spaces.



This tool is angled and has a nozzle end.

**Worktop tool**

Engineered for cleaning kitchen worktops, tables and hard surfaces.

# Getting started

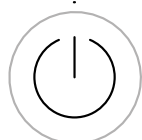

**Power button**  
Press the Power button once for comfortable, continuous cleaning.

Location of the power button on the top of the machine.



**MAX**



**Power modes**  
Press the button to change power modes.

**Max mode**  
Delivers maximum power. For intensive cleaning of ground-in dirt.

**Eco mode**  
The optimum balance of power and run time

The main body with the power button and mode button at the base of the handle and bin with the bin base closed.

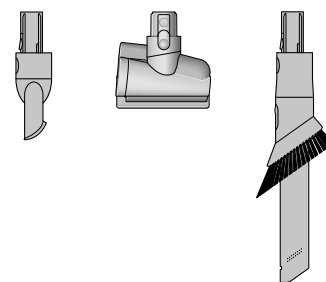
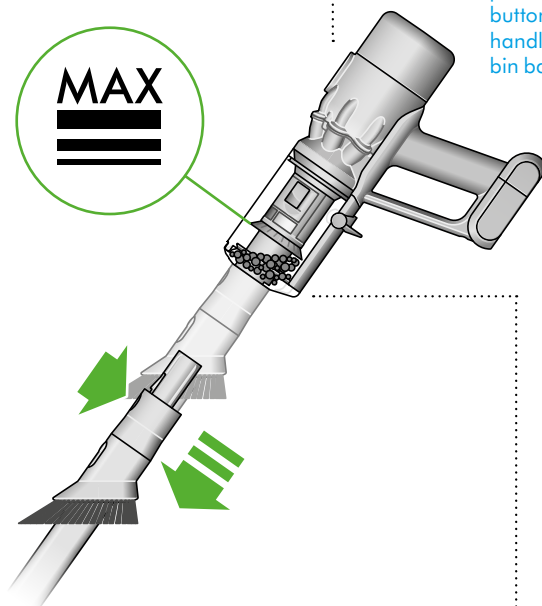

# Charging your machine

For the best experience, we recommend fully charging your machine, and any additional batteries, as soon as you open the box and after every clean.

The LED light on the end of the handle will flash when the power is running low and you need to put your battery on to charge.

Connect the charger directly to the charging point on the base of the handle of your machine. You can also connect to your dock as shown in the installation instructions supplied with your dock.

The LED light on the end of the handle will pulse with a blue LED light when charging, and the light will go out when fully charged.

It can take up to 3.5 hours to fully charge your battery. Your battery has been designed to be left on charge.

Your machine won't operate or charge if the ambient temperature is below 5°C (41°F). This is designed to protect both the motor and battery.

You can help prolong the battery life by leaving your machine to cool down before recharging.

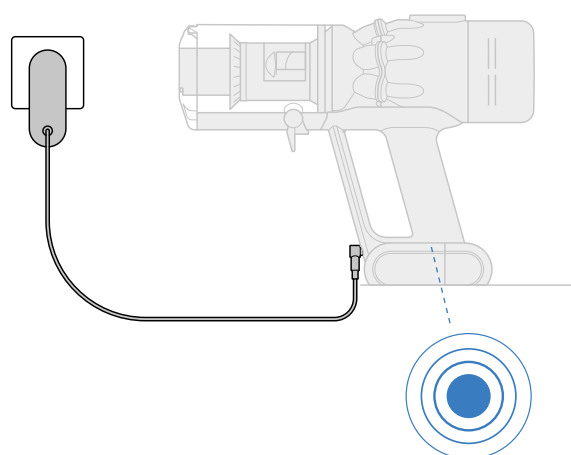
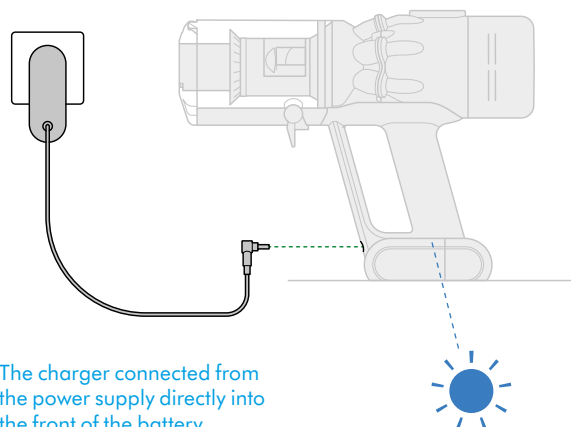

# Emptying your bin

The MAX mark on the bin of the machine, showing that the dirt should not be filled over the Max mark when the machine is at the angle of normal use.

Empty your bin as soon as the dirt reaches the MAX mark. You may need to clean the filter more often if you use your machine with a full bin.

## Release the dirt

Hold your vacuum over a bin.

Push the red bin release button, taking care not to press the power button. The bottom of the bin will open and the shroud will slide down inside the bin, wiping away any dirt.

If the bin doesn't open, check the bin release button is pushed down fully.

## To remove the bin for emptying:

If the bin doesn't empty fully, remove the bin and empty the dirt.

Press the red button located on the bin runner to release the bin and slide your bin off the runner.

## Minimize dust contact

Cover your bin tightly in a dust proof bag while you empty. Remove your bin carefully, seal the bag tightly and dispose.

## Reassemble your machine

If you have removed your bin, slide it back on to the runner. Make sure that the bin and lid are both securely in position.

Push the bin base upwards until the bin and lid both click into place. Reconnect the wand.

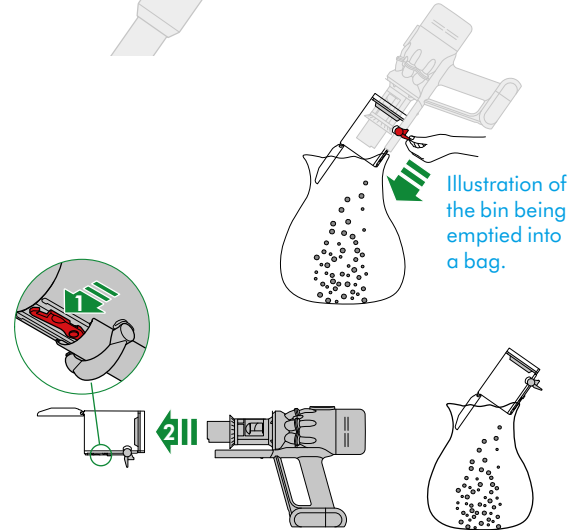
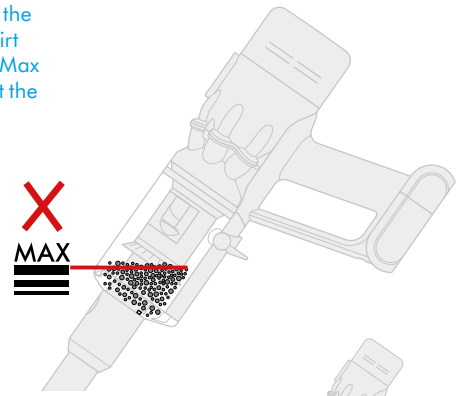

The bin lid closing with an audible click and the bin being pushed upwards with another click once it is fully in place.

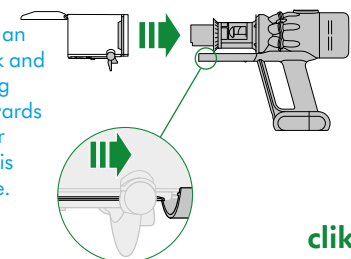

Two images of the bin with arrows showing the bin lid closing and a click symbol and the bin being pushed upwards with another click symbol.

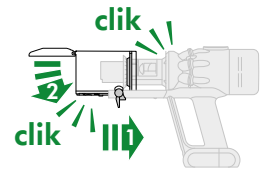

# Cleaning your bin

Don't put any part of your machine in a dishwasher or use detergents, polishes or air fresheners.

## Clean your bin

If it is necessary to clean your bin, empty it as shown in the 'Emptying your bin' section.

Press the red button located on the bin runner to release the bin and slide your bin off the runner.

Only use a damp, lint-free cloth to clean your bin.

Make sure that your bin and seals are completely dry before replacing.

## Replace your bin

Insert the spine on to the bin runner.

Close your bin by pushing the bin base upwards until the bin and bin base click into place.

The bin being removed and the location of the bin release lever on the underside of the bin runner.

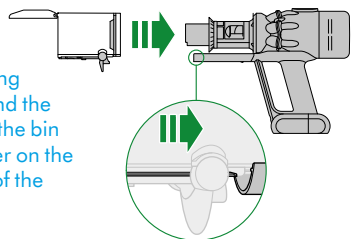

The bin being pushed back into position on the bin runner.

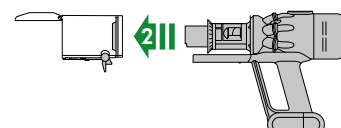

# Washing your filter

Wash your filter at least once a month to maintain the best performance.

Make sure the filter is completely dry before refitting.

## Twist off your filter

Don't put any part of your machine in a dishwasher or use detergents, polishes or air fresheners.

Turn your filter counter-clockwise and pull it away from your machine.

Before washing your filter, tap it gently over a bin to remove any loose dust and debris.

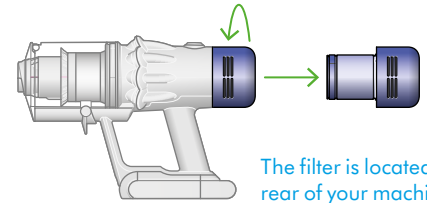

The filter is located at the rear of your machine.

## Wash your filter

Wash the outside of the filter, rubbing with your fingers to remove the dirt.

Carefully rinse the inside filter, without allowing water to fill the filter.

Repeat these steps until the water runs clear.

Holding the filter by the hard, plastic end, tap the other end over the bin.

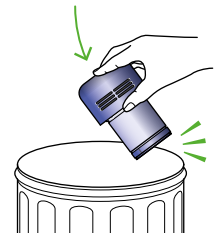

Filter held in upright position, with the wider end in the palm of a hand. Water running from a tap into the narrower end.



Filter with hand over the open end with arrows showing a shaking motion.

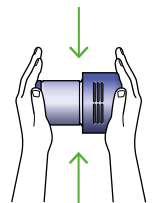

A hand holding the filter with the narrow end pointing downwards with droplets of water being shaken from the filter and again, with the end pointing downwards shaking water out.

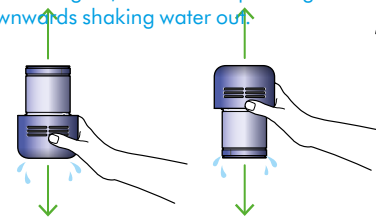

## Shake and dry

Empty the filter and shake firmly to remove excess water.

Keep shaking until there's no water coming from the filter.

Place your filter end up, as shown.

Place the filter on its end and leave to dry for at least 24 hours in a well ventilated, warm place.

Don't dry your filter in a tumble dryer, microwave or near a naked flame.

Important: your filter must be completely dry before you put it back into the machine. Your machine could be damaged if used with a damp filter.

## Refit your filter

To refit your filter, slide it onto the handle and turn it clockwise until it clicks into place.

Your filter may need more frequent washing if you vacuum fine dust, use Max mode frequently or use with the bin full.

The filter is left to dry with the pleated filter end facing upwards.



# Clearing blockages

If your machine detects a blockage, the motor will pulse six times. You won't be able to use your machine until the blockage has been cleared.

If you try to use your machine when the motor is pulsing, it will automatically cut out.

Leave your machine to cool down before looking for blockages and, for your safety, take care not to touch the power button.

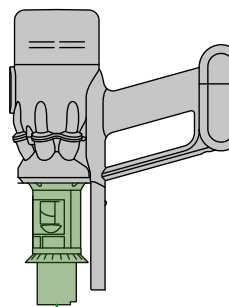

Check for blockages in the filter end and bin ends of the machine.



The bin being removed and the location of the bin release lever on the underside of the bin runner.

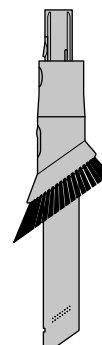
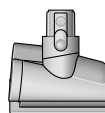
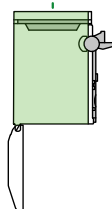

# Clearing blockages from your Hair screw tool

Your Hair screw tool doesn't have a washable brush bar. To maintain optimum performance, check your brush bar regularly and clear any obstructions.

Make sure your machine is disconnected from the charger.

## Remove the cover and brush bar

Remove the Hair screw tool from the wand or machine.

Push the base plate open. Press the red lever down to release the cleaner head cover.

Pull the cleaner head cover off the main body of the tool.

## Look for obstructions

Pull your brush bar firmly to remove it from the main body.

Check and remove any obstructions from all three parts of your Hair screw tool.

Your Hair screw tool isn't washable. Wipe over with a damp lint-free cloth.

Don't put any part of your machine in a dishwasher or use detergents, polishes or air fresheners.

## Reassemble Hair screw tool

Put your brush bar back into position and press firmly until it clicks back into position.

Check the red locking lever is in the unlocked position. Align the cleaner head cover with the guide on the main body. Push it down until it clicks into position.

Push the red locking lever up until it clicks into position and push the base plate back into place.

Location of the lever to release the brush bar is located at the back of the Hair screw tool.

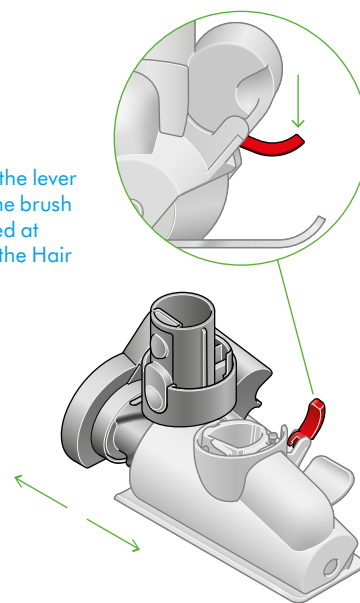

Slide the housing back on to the brush bar and push the lever on the back of the Hair screw tool upwards to lock.

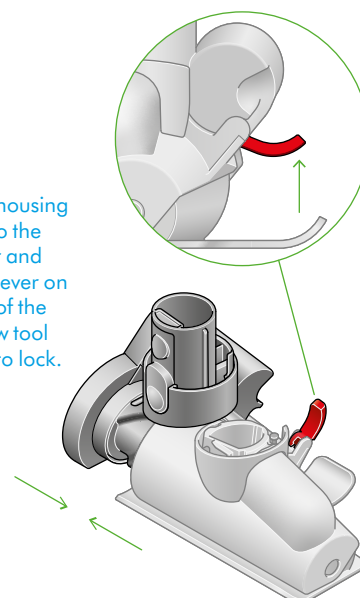



# Cleaning your tools

Don't put any part of your machine in a dishwasher or use detergents, polishes or air fresheners.

Wipe with a damp, lint-free cloth, without touching the connector end.

Make sure your tools are completely dry before using.

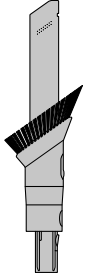

Combi-crevice tool

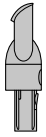

Worktop tool

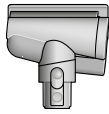

Hair screw tool

# Looking after your machine

To always get the best performance from your machine, it's important to clean it regularly and check for blockages.

## **Look after your machine**

If your machine is dusty, wipe with a damp lint-free cloth.

Check for blockages in the cleaner head and tools of your machine.

Wash your filter regularly and leave to dry completely.

Don't use detergents or polishes to clean your machine.

## **Look after your battery**

To get the best performance and life from your battery, use Eco mode.

Your machine won't operate or charge if the ambient temperature is below 5°C (41°F). This is designed to protect both the motor and battery.

## **Your serial numbers**

You can register your machine using the serial number found on the bottom of your machine.

You can find your serial numbers on your machine, battery and charger. Use your serial number to register.