

John Deere D105 Lawn Tractor

Parts and Maintenance Information

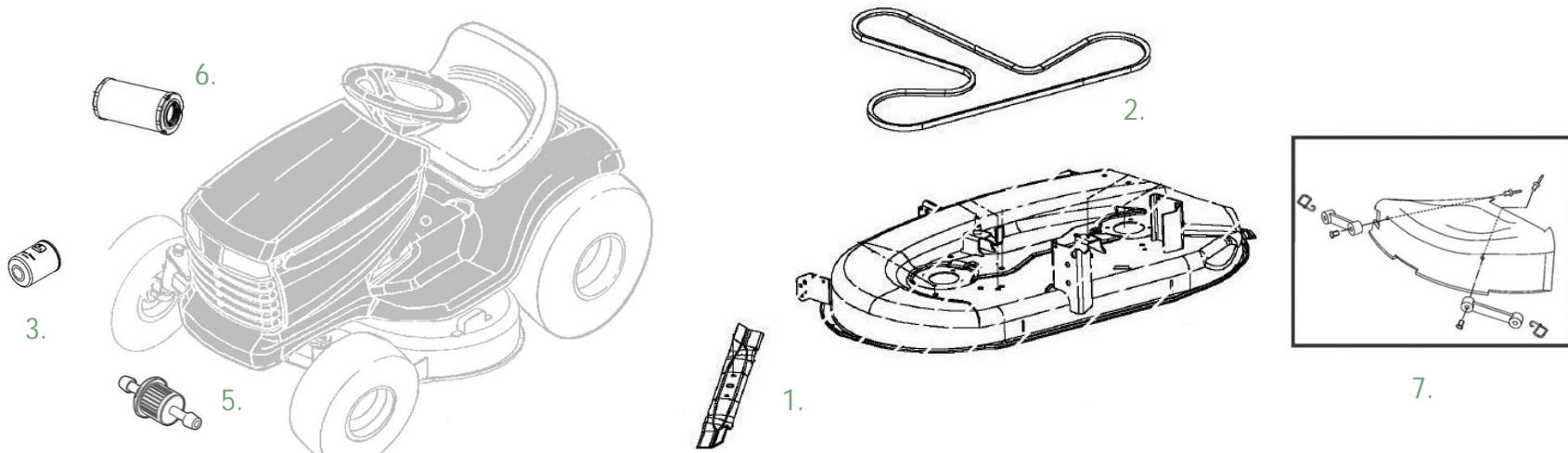

Key	Description	Part Number	THD Store SKU	THD Online SKU
1.	42 inch Mower Blade (3n1)	GY20850	469-318	100543327
2.	42 inch Mower Deck Belt	GY20072	374-857	100330463
3.	Oil Filter	GY20577	226-963	100175070
4.	Oil	TY22029	226-971	100127512
5.	Fuel Filter	GY20709	289-625	100126418
6.	Air Filter	GY21435	876-771	202722487
7.	Mulch Cover	GY00115	178-452	100670936

John Deere D105 Lawn Tractor

Parts and Maintenance Information

Service Intervals

After 8 Hours	Every 50 Hours or Annually
Change engine oil	Change engine oil & replace filter. (Service more frequently under dusty conditions.)
Check & adjust mower deck belt tension	Clean/replace air filter precleaner & element. (Service more frequently under dusty conditions.)
Check & adjust mower deck spindle brakes	Replace fuel filter.
Lubricate mower spindles	Sharpen/replace mower blades.
Lubricate pivot points	Check/replace mower drive belt.
Lubricate front axle wheel spindles & bushings	Check/adjust mower deck belt tension.
Every 25 Hours	Check/adjust mower deck spindle brakes.
Lubricate mower spindles.	Every 200 Hours
Lubricate pivot points.	Check/adjust valve clearance. See your John Deere dealer for this service.
Lubricate front axle wheel spindles & bushings	

For complete parts information for 100 Series Tractors: Visit your local John Deere Dealer or www.Deere.com

*Refer to Operators Manual for a complete listing of service intervals.

