

# B50

## Installation Instructions

Emergency Lighting Equipment

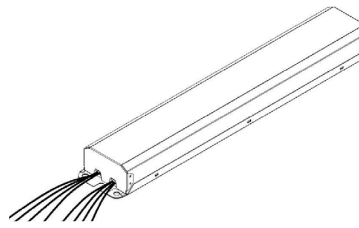

# bodine



### **! IMPORTANT SAFEGUARDS !**

**WHEN USING ELECTRICAL EQUIPMENT, BASIC SAFETY PRECAUTIONS SHOULD ALWAYS BE FOLLOWED, INCLUDING THE FOLLOWING:**

## **READ AND FOLLOW ALL SAFETY INSTRUCTIONS**

1. To prevent high voltage from being present on red & yellow output leads prior to installation, inverter connector must be open. Do not join inverter connector until installation is complete and AC power is supplied to the emergency ballast.
2. This product is for use with one or two T8, T9, T10, T12 fluorescent lamps or one 14 – 55 W (2' – 4') T5 lamp, including standard, energy saving, HO, VHO, circline, U-shaped lamps, and long compacts. It also operates one 13 – 42W 4-pin compact fluorescent lamp. It also operates one 8.5 – 16W Philips LED T8 InstantFit lamp: 9290002840, 9290002841, 9290002842, 9290002862, 9290002880, 9290002881, 9290002882, 9290002883, 9290011183, 9290011184, 9290011185, 9290011186, 9290011179, 9290011180, 9290011181, 9290011182.
3. Make sure all connections are in accordance with the National Electrical Code and any local regulations.
4. To reduce the risk of electric shock, disconnect both normal and emergency power supplies and inverter connector of the emergency ballast before servicing.
5. This emergency ballast is for factory or field installation in either the ballast channel or on top of the fixture.
6. This product is suitable for use in damp locations where the ambient temperature is 0°C minimum, +50°C maximum. Product is also suitable for installation in sealed and gasketed fixtures. Product is not suitable for heated air outlets and wet or hazardous locations.
7. An unswitched AC power source is required (120 through 277 VAC, 50 or 60 Hz).
8. Do not install near gas or electric heaters.
9. Do not attempt to service the battery. A sealed, no-maintenance battery is used that is not field replaceable. Contact the manufacturer for information on service.
10. The use of accessory equipment not recommended by the manufacturer may cause an unsafe condition.
11. Do not use this product for other than intended use.
12. Servicing should be performed by qualified service personnel.
13. Equipment should be mounted in locations and at heights where it will not be subjected to tampering by unauthorized personnel.

**CAUTION:** Verify that all replacement lamp types marked on the installed luminaire are also identified as suitable for use with this inverter/charger pack.

## **SAVE THESE INSTRUCTIONS**

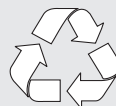

Ni - Cd

**THIS PRODUCT CONTAINS A RECHARGEABLE NICKEL-CADMIUM BATTERY.  
THE BATTERY MUST BE RECYCLED OR DISPOSED OF PROPERLY.**

02/22/19

Bodine © 2018 Signify Holding. All rights reserved.

236 Mt. Pleasant Rd. • Collierville, TN USA 38017-2752 • Tech Support 888-263-4638 • Fax 901-853-5009 • www.bodine.com  
443529060932

# INSTALLATION

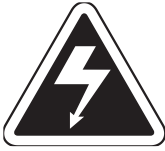

**WARNING: TO PREVENT HIGH VOLTAGE FROM BEING PRESENT ON RED & YELLOW OUTPUT LEADS PRIOR TO INSTALLATION, INVERTER CONNECTOR MUST BE OPEN. DO NOT JOIN INVERTER CONNECTOR UNTIL INSTALLATION IS COMPLETE AND AC POWER IS SUPPLIED TO THE EMERGENCY BALLAST.**

**NOTE:** Make sure the necessary branch circuit wiring is available. An unswitched source of power is required. The emergency ballast must be fed from the same branch circuit as the AC ballast.

## STEP #1 ▶ INSTALLING THE EMERGENCY BALLAST

- > Disconnect AC power from the fixture. Remove the ballast channel cover and install the emergency ballast either in the ballast channel or on top of the fixture. \* **Remote mounting distance must be less than half the maximum remote mounting distance for the AC ballast. Consult AC ballast manufacturer before remote installation.**
- > Depending on the type of fixture in use install emergency ballast using one of the methods illustrated below.
- > **Mounting Height:** This product meets or exceeds the NFPA minimum light requirements with all loads, down to the smallest rated lamp load, at heights up to 7.17ft (2.2m). Many factors influence emergency illumination levels, such as the lamp load selected, luminaire design, and environmental factors therefore end use verification is necessary. For field installations, when the attached luminaire is mounted at heights greater than 7.17ft (2.2m), the level of illumination must be measured in the end application to ensure the requirements of NFPA 101 and local codes are satisfied.

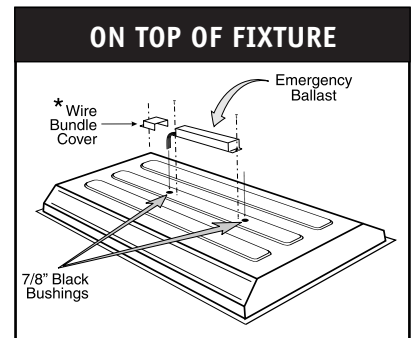
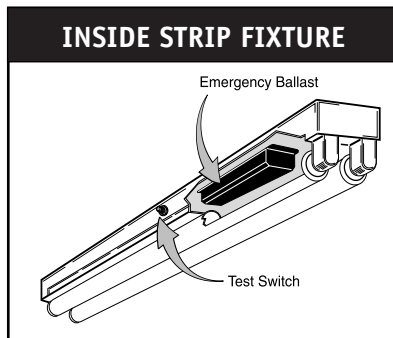
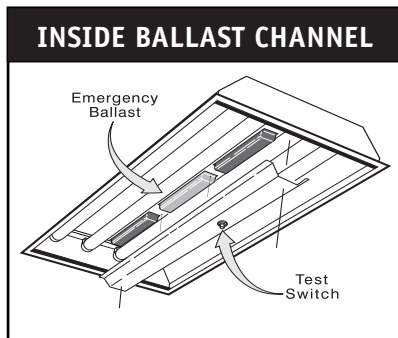

\* For installation on top of the fixture, wire bundle covers (RMC-60) may be required by state or local codes. These covers are available from the manufacturer as an accessory kit and must be ordered separately. Call your local distributor or the factory for complete information.

## STEP #2a ▶ INSTALLING THE 2W-ITS ON FIXTURE SURFACE

- > Drill a 1/2" hole and install the test switch as shown.
- > Wire the test switch per wiring diagrams provided on these instructions.
- > If wired correctly, the 2W-ITS indicator light should be ON when AC power is supplied to the fixture, indicating that the emergency ballast battery is charging. After installing, mark with the "PUSH TO TEST" and "CHARGING INDICATOR LIGHT" labels.

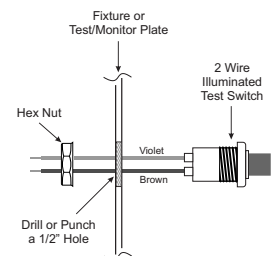

## STEP #2b ▶ INSTALLING THE 2W-ITS ON THE BALLAST CHANNEL COVER

- > Drill or punch a 7/8 inch hole in ballast channel cover and insert bushing.
- > Slide the 2W-ITS tube up or down to adjust the height and visibility of the charging indicator light.
- > If the tube is too long, cut the plastic tubing to necessary length.
- > After cutting the tube to the proper length, assemble the 2W-ITS. To assemble the 2W-ITS:
- > Feed the switch leads through the plastic tubing.
- > Insert the white bushing in the opposite end of tube from the switch body.
- > Pull switch leads and use provided tie wrap to secure leads snug against white bushing.
- > Unscrew hex nut to apply tension to leads.

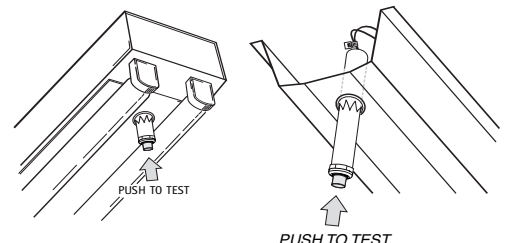
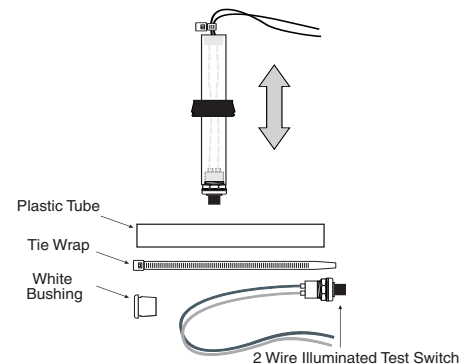

**NOTE:** After installing the test switch, mark with the appropriate label.

# INSTALLATION

## STEP #3 ► WIRING THE EMERGENCY BALLAST

- > Determine the type of AC ballast installed in the fixture.
- > Select the appropriate wiring diagram on back to connect the emergency ballast to the AC ballast and lamp(s). Make sure all connections are in accordance with the National Electrical Code and any local regulations.
- > After installation is complete, supply AC power to the emergency ballast and join the inverter connector.
- > At this point, power should be connected to both the AC ballast and the emergency ballast, and the Charging Indicator Light should illuminate indicating the battery is charging.
- > A short-term discharge test may be conducted after the emergency ballast has been charging for one hour. Charge for 24 hours before conducting a long-term discharge test. Refer to OPERATION.
- > In a readily visible location, attach the label "**CAUTION - This Unit Has More Than One Power Connection Point. To Reduce The Risk Of Electric Shock, Disconnect Both The Branch Circuit-Breakers Or Fuses And Emergency Power Supplies Before Servicing.**"

## OPERATION

During normal operation AC power is applied, the charging indicator light is illuminated, indicating that the battery is being charged. When power fails, the ballast automatically switches to emergency power (internal battery), operating either one or two lamps for a minimum of 90 minutes. When AC power is restored, the emergency ballast returns to the charging mode and delays AC ballast operation for three seconds to prevent false-tripping of AC ballast (end-of-lamp-life) shutdown circuits.

## MAINTENANCE

Although no routine maintenance is required to keep the emergency ballast functional, it should be checked periodically to ensure that it is working. The following schedule is recommended:

1. Visually inspect the charging indicator light monthly. It should be illuminated.
2. Test the emergency operation of the fixture at 30-day intervals for a minimum of 30 seconds. One or two lamps should operate at reduced illumination.
3. Conduct a 90-minute discharge test once a year. One or two lamps should operate at reduced illumination for at least 90 minutes.

**! REFER ANY SERVICING INDICATED BY THESE CHECKS TO QUALIFIED PERSONNEL !**

## WIRING DIAGRAMS

The following diagrams are typical schematics only. May be used with other ballasts. Consult the factory for other wiring diagrams. Emergency Ballast and AC Ballast must be fed from the SAME BRANCH CIRCUIT.

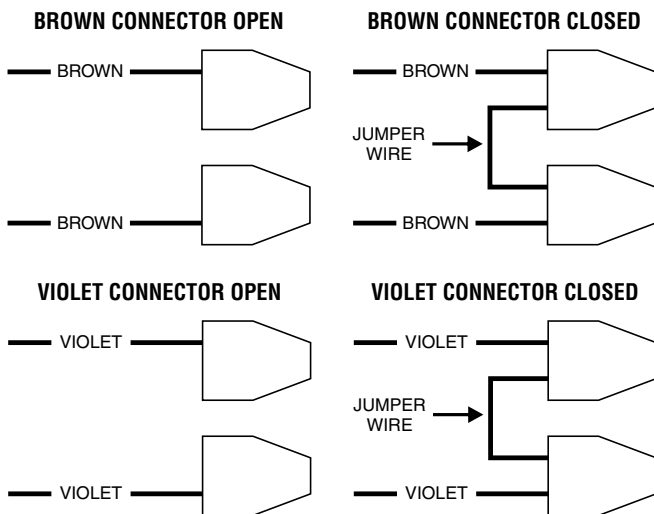

**IMPORTANT TEXT: REFER TO TABLE 1 REGARDING BROWN AND VIOLET CONNECTOR**

**Table 1**

LAMP (DIAMETER)	BASE TYPE	WATTAGE (Length)	NO. of LAMPS (EMERGENCY)	BROWN CONNECTOR	VIOLET CONNECTOR
(1", 1¼", 1½") T8, T9, T10, T12	Single or Bipin	17 - 40 W (2'-4')	1	CLOSED	OPEN
		40 - 215 W (5'-8')	2	OPEN	CLOSED
LONG COMPACT	4-PIN (2G11)	18 - 39 W	1	OPEN	CLOSED
		40 - 55 W	1	CLOSED	OPEN
TWIN/QUAD/TRIPLE TWIN-TUBE COMPACT	4-PIN (G24q, Gx24q)	13 - 42 W	1	CLOSED	OPEN
T5 & T5 HO	MINIATURE BIPIN	14 - 54 W (2'-4')	1	CLOSED	OPEN
	HO CIRCLINE	22 - 55 W	1	CLOSED	OPEN
2D	4-PIN (GR10q)	16 - 55 W	1	CLOSED	OPEN
Philips LED T8 InstantFit	Bipin	8.5 - 16.5 W	1	CLOSED	OPEN

**"The supplied brown jumper wire can be used to connect either the brown wires or the violet wires."**

**EMERGENCY BALLAST AND AC BALLAST MUST BE FED FROM THE SAME BRANCH CIRCUIT**  
 TYPICAL SCHEMATICS ONLY. MAY BE USED WITH OTHER BALLASTS. CONSULT THE FACTORY FOR OTHER WIRING DIAGRAMS.

**WIRING DIAGRAM for 1-LAMP emergency operation**

FIG A ONE (1) LAMP RAPID START BALLAST

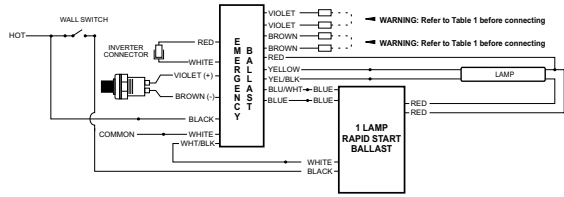

FIG B ONE (1) LAMP INSTANT START BALLAST

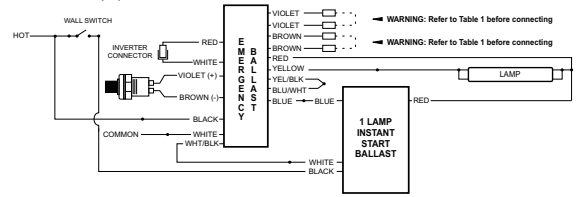

FIG C TWO (2) LAMP RAPID START BALLAST

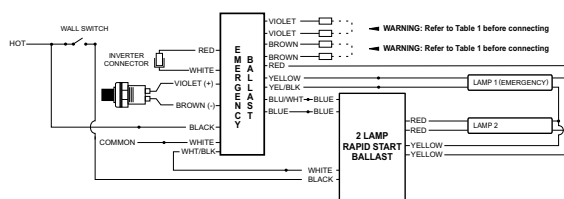

FIG D TWO (2) LAMP INSTANT START BALLAST

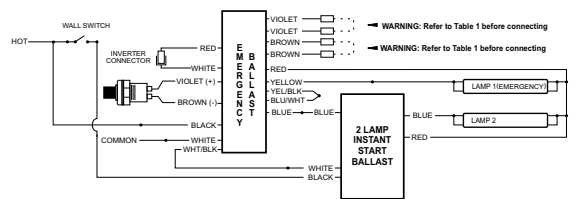

FIG E THREE (3) LAMP RAPID START BALLAST

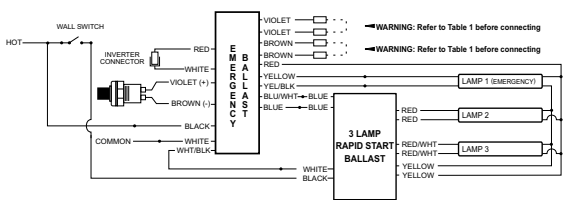

FIG F THREE (3) LAMP INSTANT START BALLAST

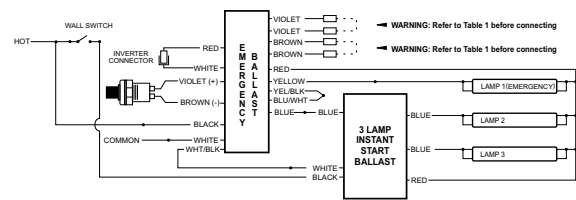

FIG G FOUR (4) LAMP RAPID START BALLAST

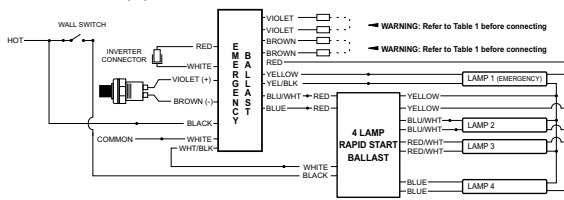

FIG H FOUR (4) LAMP INSTANT START BALLAST

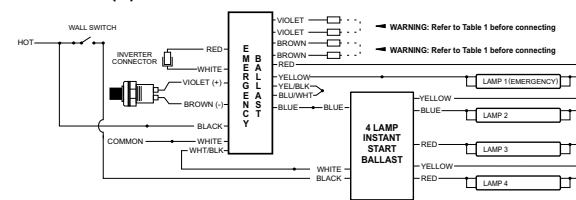

FIG I ONE (1) LAMP COMPACT RAPID START BALLAST

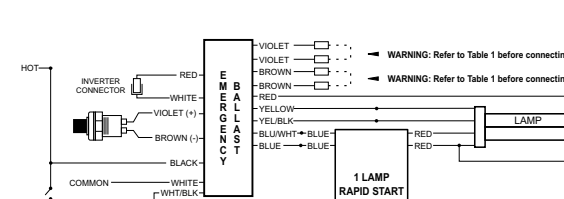
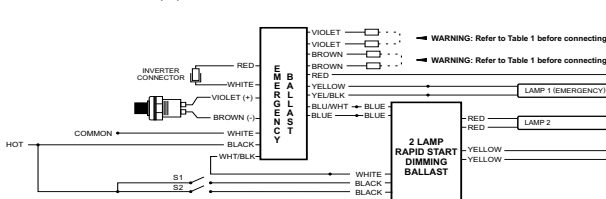

FIG J TWO (2) LAMP RAPID START STEP DIMMING BALLAST



# WIRING DIAGRAMS FOR 2-LAMP EMERGENCY OPERATION (2 - 4', 17- 40 W LAMPS ONLY)

Two-lamp emergency operation is not possible with all ballasts.  
Consult the factory for any ballast other than those shown.

FIG K TWO (2) LAMP RAPID START BALLAST

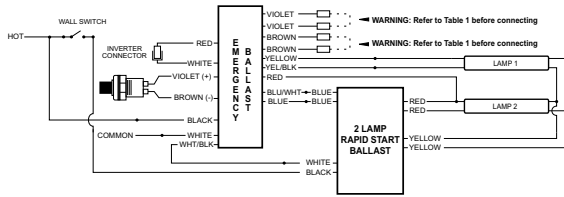

FIG L TWO (2) LAMP INSTANT START BALLAST

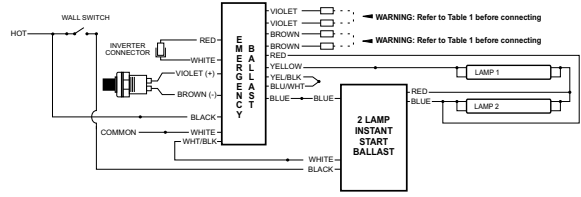

FIG M THREE (3) LAMP RAPID START BALLAST

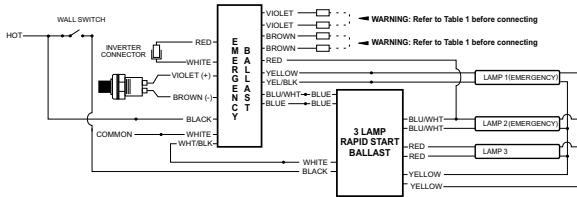

FIG N THREE (3) LAMP INSTANT START BALLAST

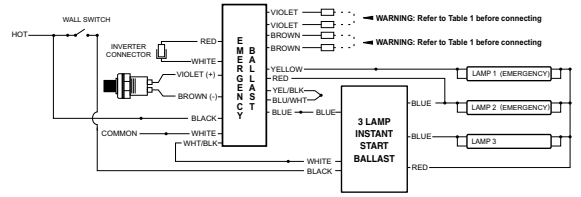

FIG O FOUR (4) LAMP RAPID START BALLAST

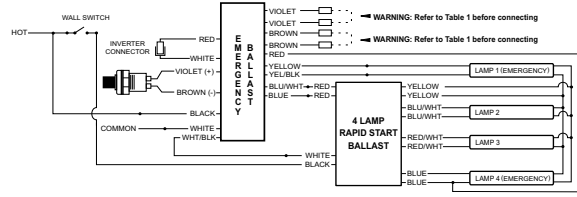
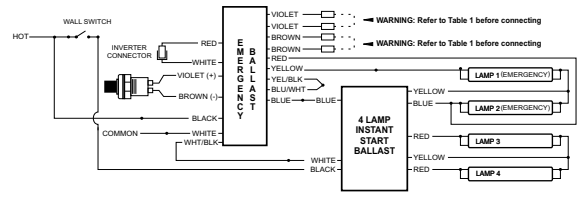

FIG P FOUR (4) LAMP INSTANT START BALLAST



## WIRING DIAGRAMS for EMERGENCY-ONLY fixtures

FIG R ONE (1) LAMP WITHOUT AC BALLAST (16W-215W)

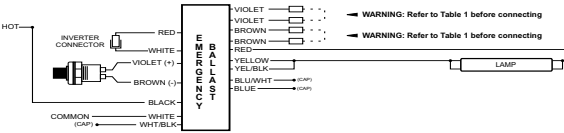

FIG S TWO (2) LAMPS WITHOUT AC BALLAST (17W-40W)

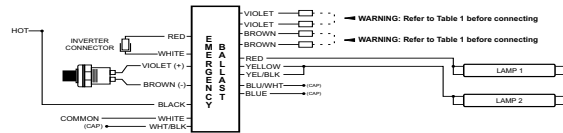

FIG T ONE (1) 4-PIN COMPACT LAMP WITHOUT AC BALLAST (16W-55W)

