



MODEL W1667

8¹/₂" Oscillating Drill Press



INSTRUCTION MANUAL

Phone: 1-360-734-3482 • On-Line Technical Support: tech-support@shopfox.biz

COPYRIGHT © 2000 BY WOODSTOCK INTERNATIONAL, INC. REVISED FEBRUARY, 2004.

WARNING: NO PORTION OF THIS MANUAL MAY BE REPRODUCED IN ANY SHAPE OR FORM WITHOUT
THE WRITTEN APPROVAL OF WOODSTOCK INTERNATIONAL, INC.

WARNING

Some dust created by power sanding, sawing, grinding, drilling, and other construction activities contains chemicals known to the State of California to cause cancer, birth defects or other reproductive harm. Some examples of these chemicals are:

- Lead from lead-based paints.
- Crystalline silica from bricks, cement, and other masonry products.
- Arsenic and chromium from chemically treated lumber.

Your risk from these exposures varies, depending on how often you do this type of work. To reduce your exposure to these chemicals: work in a well ventilated area, and work with approved safety equipment, such as those dust masks that are specially designed to filter out microscopic particles.

CONTENTS

INTRODUCTION	2
About Your W1667 8 1/2" Oscillating Drill Press	2
Woodstock Service and Support	2
Warranty and Returns	3
Specifications	3
SAFETY	4
Standard Safety Instructions	4
Additional Safety Instructions for Drill Presses	5
Avoiding Potential Injuries	6
ELECTRICAL	7
110V Operation	7
Grounding	7
Extension Cords	7
ASSEMBLY	8
Box Contents	8
Base and Column	9
Dust Port	9
Table	10
Headstock	11
Drill Chuck	12
Handles	12
ADJUSTMENTS	13
Belt Tension	13
Feed Shaft Spring Tension	14
Quill-Shaft Screw	15
Table Height / Tilt	16
Drilling Speed	17
Drill Press RPM Chart	18
Drilling Depth	18
Drill, Cutter, and Hole Saw Suggested RPM Chart	19
OPERATIONS	21
Starting the Drill Press	21
Drill/Drum Changes	22
Using the Oscillator	23
MAINTENANCE	25
General	25
Lubrication	25
Table and Base	25
Sanding Sleeves	25
Troubleshooting	26
Parts Diagram	27
Parts List	28
Drill Press Accessories	29



INTRODUCTION

About Your W1667 8 1/2" Oscillating Drill Press

This new **SHOP FOX®** Model W1667 8 1/2" Oscillating Drill Press has been specially designed by Woodstock International, Inc. to provide many years of trouble free service. Close attention to detail, ruggedly built parts and a rigid quality control program assure safe and reliable operation.

The Model W1667 8 1/2" Oscillating Drill Press is a drill press and an oscillating sander in one compact machine. It is capable of a wide variety of drilling and sanding operations. A sanding spindle is included for use with drums ranging in size from 1" to 2" diameter and 4 1/4" long. Purchasing drums and sleeves will allow you to sand small or finely detailed pieces; and with the oscillating feature, your abrasives will last longer and provide a better finish. The tilting table allows surfaces to be sanded at many different angles. Included are table inserts to give maximum support for the workpiece and a dust port for connection to your dust collection system. The Model W1667 is packaged with a drill chuck, motor and paddle switch with removable safety key.

Woodstock International, Inc. is committed to customer satisfaction in providing this manual. It is our intent to make sure all the information necessary for safety, ease of assembly, practical use and durability of this product be included.

If you need the latest revised edition of this manual, you can download it from <http://www.shopfox.biz>. If you still have questions after reading the latest revised manual, or if you have comments please contact us at:

Woodstock International, Inc.
Attn: Technical Department
P.O. Box 2309
Bellingham, WA 98227

Woodstock Service and Support

We stand behind our machines! In the event that a defect is found, parts are missing or questions arise about your machine, please contact Woodstock International Service and Support at 1-360-734-3482 or at tech-support@shopfox.biz. Our knowledgeable staff will help you troubleshoot problems, send out parts or arrange warranty returns.

Warranty and Returns

Woodstock International, Inc. warrants all **SHOP FOX**[®] machinery to be free of defects from workmanship and materials for a period of 2 years from the date of original purchase by the original owner. This warranty does not apply to defects due directly or indirectly to misuse, abuse, negligence or accidents, lack of maintenance, or to repair or alterations made or specifically authorized by anyone other than Woodstock International, Inc.

Woodstock International, Inc. will repair or replace, at its expense and at its option, the **SHOP FOX**[®] machine or machine part which in normal use has proven to be defective, provided that the original owner returns the product prepaid to the **SHOP FOX**[®] factory service center or authorized repair facility designated by our Bellingham, WA office, with proof of their purchase of the product within 2 years, and provides Woodstock International, Inc. reasonable opportunity to verify the alleged defect through inspection. If it is determined there is no defect, or that the defect resulted from causes not within the scope of Woodstock International Inc.'s warranty, then the original owner must bear the cost of storing and returning the product.

This is Woodstock International, Inc.'s sole written warranty and any and all warranties that may be implied by law, including any merchantability or fitness, for any particular purpose, are hereby limited to the duration of this written warranty. We do not warrant that **SHOP FOX**[®] machinery complies with the provisions of any law or acts. In no event shall Woodstock International, Inc.'s liability under this warranty exceed the purchase price paid for the product, and any legal actions brought against Woodstock International, Inc. shall be tried in the State of Washington, County of Whatcom. We shall in no event be liable for death, injuries to persons or property or for incidental, contingent, special or consequential damages arising from the use of our products.

Every effort has been made to ensure that all **SHOP FOX**[®] machinery meets high quality and durability standards. We reserve the right to change specifications at any time because of our commitment to continuously improve the quality of our products.

Specifications

Motor Type:	TEFC Capacitor Start Induction
Motor:	1/2 HP, 110V, 5 Amp., Single Phase / 60 Hz
RPM:	1725
Power Transfer:	V-Belt Drive
Bearings:	Shielded & Lubricated Ball Bearings
Switch:	Toggle ON/OFF Switch, W/ Safety Lock Tab
Oscillating Stroke Length:	1/2"
Spindle Travel:	1 5/8"
Maximum Distance, Spindle to Base:	11"
Maximum Distance, Spindle to Table:	8"
Overall Height:	23"
Dust Port Size:	2 1/4"
Spindle Taper:	JT-33
Table Swing:	8 1/2"
Table Tilt:	90°
Chuck Size:	1/2" (1-13mm JT-33), Keyed
Speeds:	5, Belt Controlled
Range of Speeds:	620, 1100, 1720, 2340, 3100 RPM
Drilling Capacity:	1/2" Diameter in Steel
Approximate Shipping Weight:	54 lbs.

SAFETY

READ MANUAL BEFORE OPERATING MACHINE FAILURE TO FOLLOW INSTRUCTIONS BELOW WILL RESULT IN PERSONAL INJURY



Indicates an imminently hazardous situation which, if not avoided, **WILL** result in death or serious injury.



Indicates a potentially hazardous situation which, if not avoided, **COULD** result in death or serious injury.



Indicates a potentially hazardous situation which, if not avoided, **MAY** result in minor or moderate injury and damage to the machine. It may also be used to alert against unsafe practices.

NOTICE

This symbol is used to alert the user to useful information about proper operation of the equipment.

Standard Safety Instructions

1. **Thoroughly read the instruction manual before operating your machine.** Learn the applications, limitations and potential hazards of this machine. Keep manual in a safe, convenient place for future reference.
2. **Keep work area clean and well lighted.** Clutter and inadequate lighting invite potential hazards.
3. **Ground all tools.** If a machine is equipped with a three-prong plug, it must be plugged into a three-hole electrical outlet or grounded extension cord. If using an adapter to aid in accommodating a two-hole receptacle, ground the adapter using a screw to a known ground.
4. **Wear eye protection at all times.** Use safety glasses with side shields or safety goggles, meeting the national safety standards, while operating this machine.
5. **Avoid dangerous environments. DO NOT** operate this machine in wet or open flame environments. Airborne dust particles could cause an explosion and severe fire hazard.
6. **Ensure all guards are securely in place** and in working condition.
7. **Make sure switch is in the “OFF” position** before connecting power to machine.
8. **Keep work area clean;** free of clutter, grease, etc.
9. **Keep children and visitors away.** All visitors should be kept at a safe distance away while operating unit.
10. **Childproof workshop** with padlocks, master switches or by removing starter keys.
11. **Disconnect machine when cleaning, adjusting or servicing.**

12. **DO NOT force tool.** The machine will do a safer and better job at the rate for which it was designed.
13. **Use correct tool. DO NOT force machine or attachment to do a job for which it was not designed.**
14. **Wear proper apparel. DO NOT wear loose clothing, neck ties, gloves, jewelry, etc.**
15. **Remove adjusting keys and wrenches.** Before turning the machine on, make it a habit to check that all adjusting keys and wrenches have been removed.
16. **Use proper extension cord.** When using an extension cord, make sure it is in good condition. When extension cord is 100' and less in length, use those that are rated Standard Service (grade S) or better, and that have a conductor size of 16 A.W.G. A drop in line voltage, loss of power and overheating can result when using an undersized cord. The extension cord should have a ground wire and ground plug pin, as well.
17. **Keep proper footing and balance at all times.**
18. **DO NOT leave machine unattended.** Wait until it comes to a complete stop before leaving the area.
19. **Perform machine maintenance and care.** Follow lubrication and accessory attachment instructions in the manual.
20. **Keep machine away from open flame.** Operating machines near pilot lights and/or open flames creates a high risk if dust is dispersed in the area. Dust particles and an ignition source may cause an explosion. Do not operate the machine in high risk areas, including but not limited to, those mentioned above.

Additional Safety Instructions for Drill Presses

1. **Always operate your drill press at speeds that are appropriate for the drill bit size and the material that you are drilling.**
2. **Feed the drill bit evenly into the workpiece.** Back the bit out of deep holes and clear the chips with a brush after you have turned the machine off.
3. **Make sure the drill bit you are using is tightened properly.** Use only round, hex or triangular shank drill bits.
4. **Never do maintenance or change speeds with this machine plugged in.**
5. **Never use tools that are in poor condition.** Cutting tools that are dull or damaged are difficult to control and may cause serious injury.
6. **Never drill sheet metal unless it is clamped securely to the table.**
7. **Properly position workpieces to avoid drilling into the table.**
8. **A face guard used with safety glasses is recommended.**
9. **Always clamp workpiece securely to table before drilling.** Never hold a workpiece by hand while drilling.
10. **Always remove handles before using oscillating feature.**
11. **Habits - good and bad - are hard to break.** Develop good habits in your shop and safety will become second-nature to you.

Avoiding Potential Injuries

SAFETY

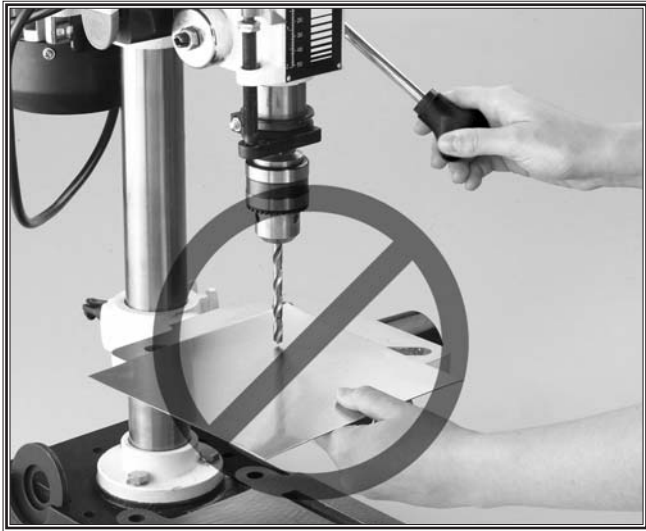

Figure 1. Never drill while holding the workpiece by hand.



Figure 2. Keep fingers away from spinning drill bits, cutters, and sanding surfaces.



Figure 3. Remove switch safety key when not in use.



Figure 4. Remove handles when using the oscillating sanding feature.

ELECTRICAL

110V Operation

The SHOP FOX® W1667 8 1/2" Oscillating Drill Press can only be operated at 110 volts (see Figure 5). The motor draws approximately 5 amps. Choose an outlet with a 10 amp circuit breaker or fuse protection. Remember circuits being used by other machines at the same time add to the total electrical load being applied by this machine. If this total amperage load exceeds the amperage rating of the circuit breaker or fuse, use a different circuit with a higher amperage rating.

DO NOT modify an existing low-amperage circuit by only replacing the circuit breaker with a breaker rated for a higher amperage. The breaker and the complete circuit must be replaced by a qualified electrician.

Grounding

Ground this machine! The electrical cord supplied with the W1667 8 1/2" Oscillating Drill Press comes with a grounding pin. **DO NOT** remove the pin if your outlet does not accept a ground pin, see Figure 5a. Have the outlet box replaced by a qualified electrician or have an appropriate adapter installed. Remember, an adapter with a grounding wire does not guarantee the machine will be grounded. A ground source must always be verified in the electrical circuit within the wall or conduit.

Extension Cords

Using an extension cord with an undersized gauge or one that is too long, generates heat in the cord that may cause fire or circuit damage. If you must use an extension cord, use the guidelines below to determine the correct cord length and gauge. The amp rating of the motor is 9 amps and can be found on its nameplate.

- Use a cord rated for Standard Service (Grade S)
- Use a cord that is 16 gauge and 100 feet or less only
- Use a cord with a ground wire and pin
- Use only undamaged cords

⚠ WARNING

DISCONNECT power to machine before performing any electrical or mechanical service or maintenance. Seek assistance from a qualified electrician if you do not understand the wiring diagram in this manual. Always follow the applicable electrical codes and standards. Otherwise serious personal injury or death may occur!

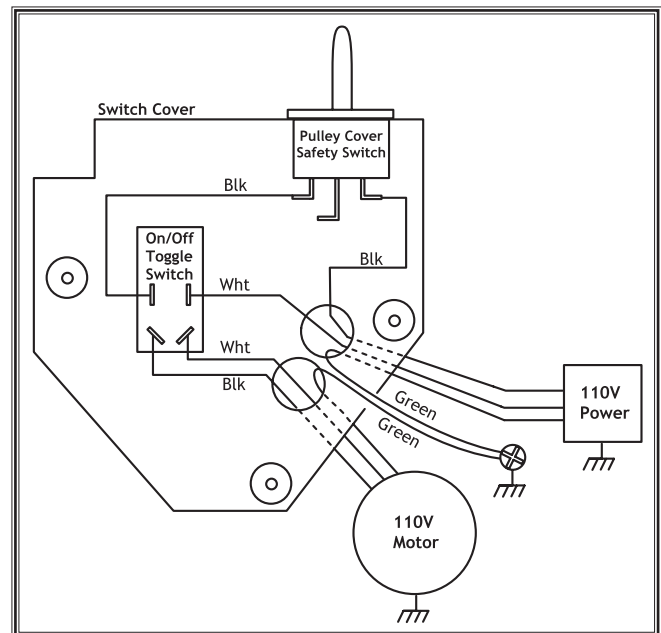

Figure 5. Model W1667 wiring diagram.

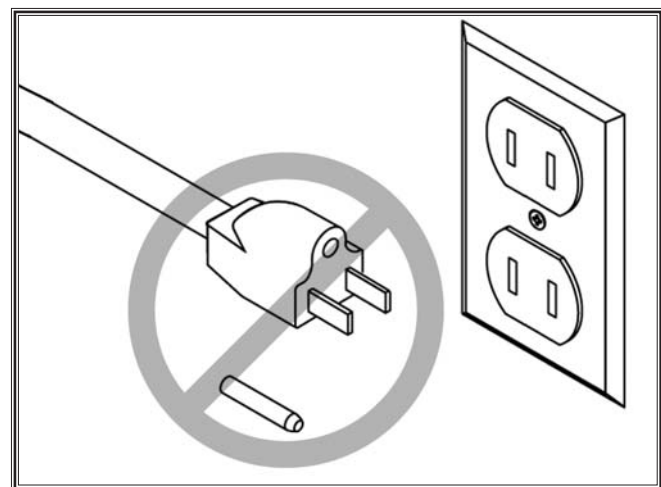
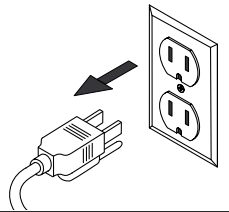

Figure 5a. Never remove grounding pin.

ELECTRICAL

ASSEMBLY



⚠ WARNING
UNPLUG machine before any assembly procedures. Otherwise serious personal injury may occur!



⚠ WARNING
WEAR safety glasses during all assembly procedures. Otherwise serious personal injury may occur!

Box Contents

The following is a list of the components shipped with the W1667 8 1/2" Oscillating Drill Press. Inventory the components in a similar fashion as shown in Figure 6, and assembly will be quicker and easier. If any part is missing, examine the packaging carefully and check under the belt guard. If any parts are still missing, contact Woodstock International, Inc. at 1-360-734-3482 or tech-support@shop-fox.biz.

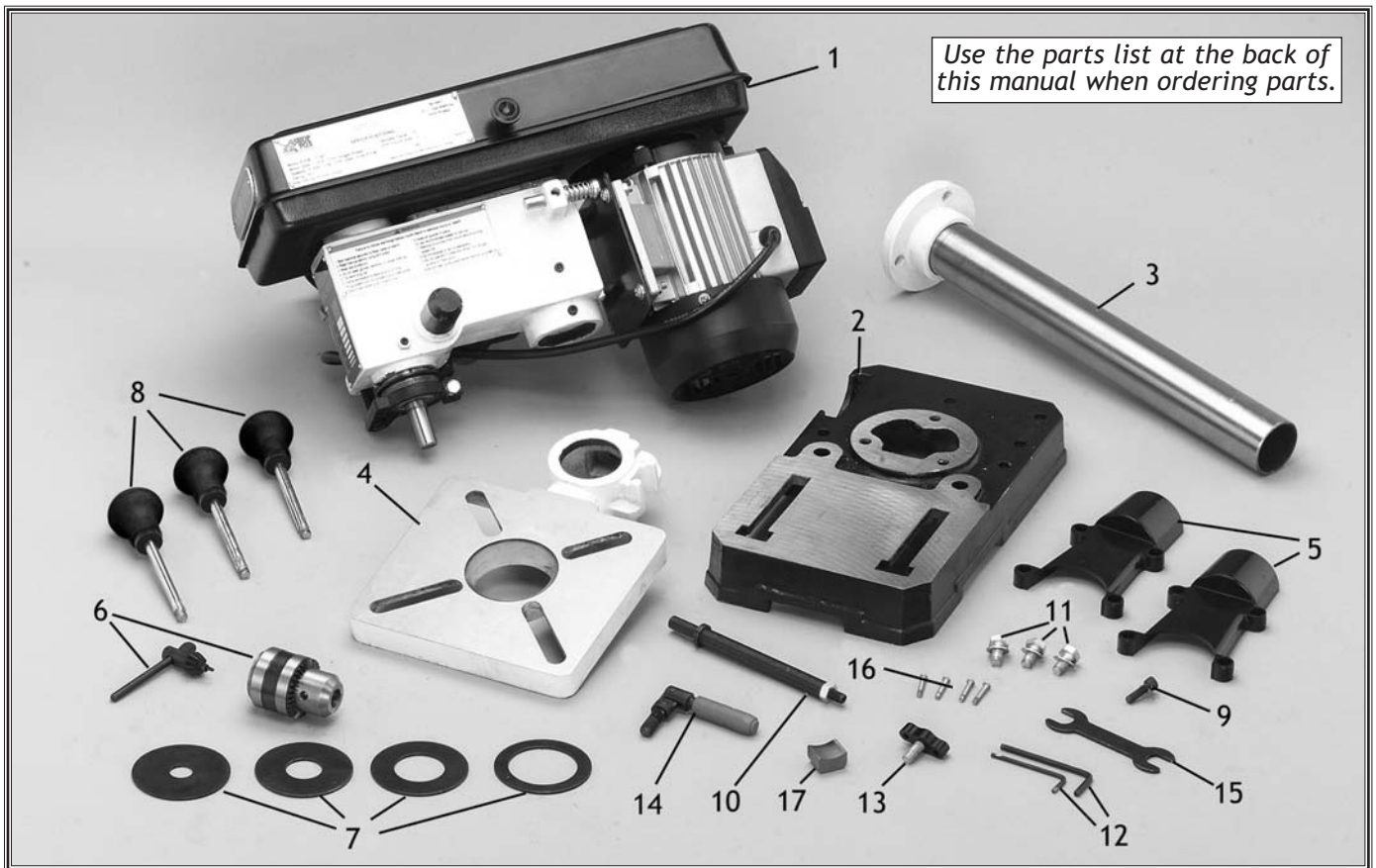

Figure 6. Components laid out for identification.

- | | | |
|------------------------|--------------------------|------------------------------|
| 1. Headstock | 7. Table Inserts (4) | 13. Belt Tension Knob |
| 2. Base | 8. Spindle Handles (3) | 14. Table Lock Knob |
| 3. Column | 9. Cap Screw and Washers | 15. Open End Wrench |
| 4. Table | 10. Sanding Spindle | 16. Phillips Head Screws (4) |
| 5. Dust Port | 11. Hex Head Bolts (3) | 17. Lock Shoe |
| 6. Drill Chuck and Key | 12. Hex Wrenches (2) | |

Base and Column

The base and column must be securely mounted, so if drilling an odd-shaped workpiece the machine will not fall over.

To install the base and column, do these steps:

1. Position the drill press base on a flat and stable surface.
2. Using two clamps, clamp the base to the mounting surface.
3. Use the holes provided in the bottom of the base as a drill guide, and drill holes in the mounting surface. See **Figure 7**.
4. Secure the base using $\frac{5}{16}$ " lag bolts or supplied through bolts with washers and nuts.
5. Place the column on the base, line up the 3 mounting holes, and secure tightly with the three M8-1.25 x 16mm hex head bolts using the open-end wrench provided.

Dust Port

The dust port directs suction to the sanding sleeve, removing hazardous dust and increasing abrasive life.

To install the dust port, do these steps:

1. Position the two-piece dust port to the bottom of the table. See **Figure 8**.
2. Insert the four M4-0.7 x 22mm Phillips head screws and tighten.



Figure 7. Using holes as a drill guide.



Figure 8. Installing the dust port.

Table

When installed correctly, the table should lock in position with firm lever torque.

To install the table, do these steps:

1. Thread the table lock handle 3 turns into the table support bracket.
2. Insert the lock shoe into the pocket located inside the hole of the table support bracket. See **Figure 9**.
3. Slide the table support bracket onto the column until the table support bracket is near the bottom of the column.
4. Tighten the table lock handle to lock the table in position.

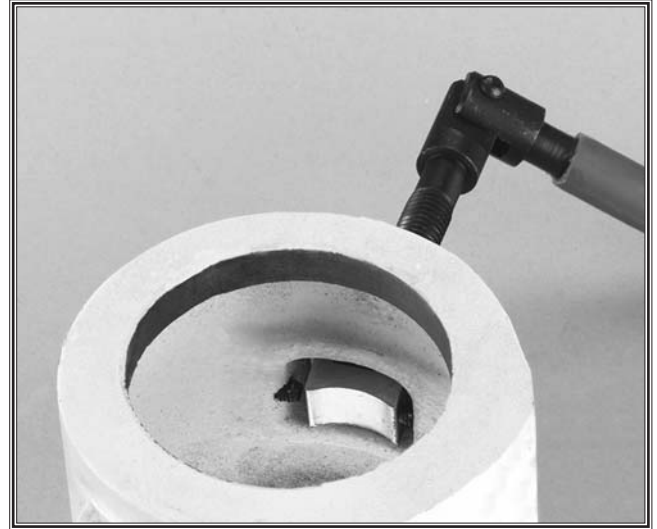
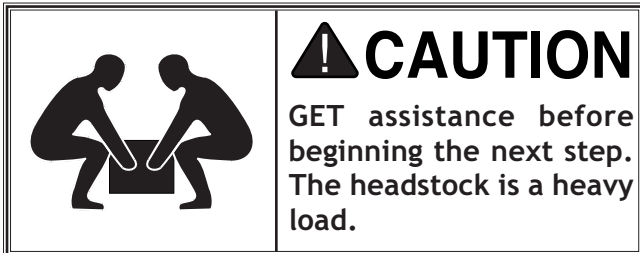

Figure 9. Loosely installing table lock lever.

Headstock

The headstock must be tightened in position with the setscrew so the headstock is aligned with the drill press base for balance and weight distribution. **DO NOT** over tighten the set screw and strip the threads or bend the column.



To install the headstock, do these steps:

1. With an assistant, position the pocket over the column and allow the headstock to slide down until the column fully seats up and into the headstock (approximately 2"). See **Figure 10**.
2. Align the headstock directly over the foot of the base as viewed from the front of the drill press.
3. Tighten the two setscrews to secure the headstock to the column. See **Figure 11**.



Figure 10. Aligning the pocket in the headstock with the column.

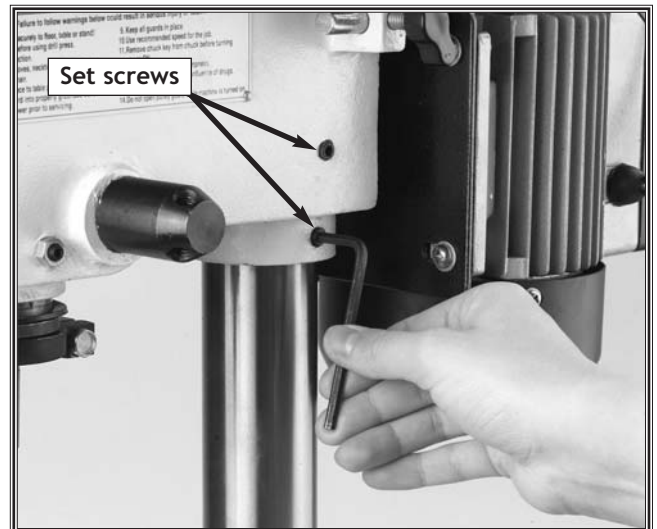

Figure 11. Securing the headstock to the column.

Drill Chuck

The drill chuck is seated to the spindle with a JT-33 tapered surface and a screw.

To install the drill chuck, do these steps:

1. Clean the drill chuck and spindle with mineral spirits and follow all safety warnings on the container. Failure to clean the tapered-mating surfaces of the spindle and drill chuck will result in the chuck falling off during use.
2. Use the provided chuck key to adjust the jaws of the chuck until they are well inside the drill chuck body. See **Figure 12**.



Figure 12. Jaws adjusted inside chuck body.

NOTICE

DO NOT use a hammer to seat the drill chuck onto the spindle. You will damage the oscillating mechanism.

3. Place the drill chuck on the spindle, and insert the cap screw into the hole of the drill chuck. See **Figure 13**.
4. Tighten the cap screw so the drill chuck is seated securely on the spindle.
 - If the chuck fails to remain secure on the spindle, repeat **Step 1**, **DO NOT** use a hammer to seat the drill chuck onto the spindle!

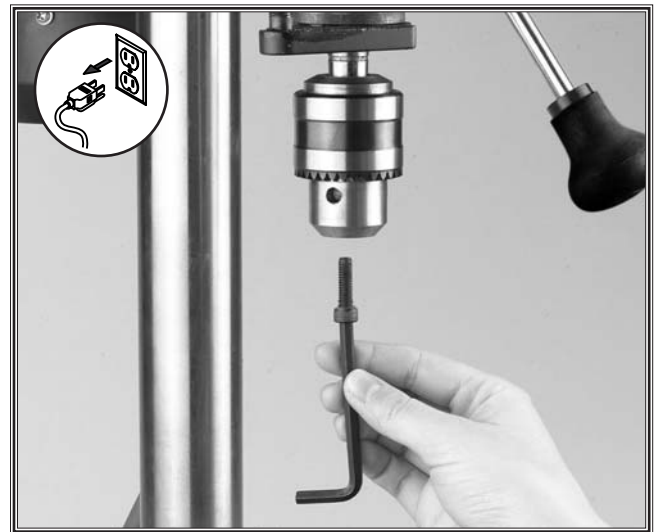

Figure 13. Inserting the caps crew.

Handles

Three handles are supplied for drilling operations. **NOTE:** remove these handles when you use the oscillating feature.

To install the handles, do these steps:

1. Thread the handles into the hub as shown in **Figure 14**.
2. Tighten the handles until they are snug, **DO NOT** over-tighten.



Figure 14. Installing spindle handles.

ADJUSTMENTS

Belt Tension

The drill press drive belt lasts a long time; however, during its life the belt may stretch slightly, which can cause the pulleys to slip under a load. You will then need to adjust the drive belt tension.

NOTICE

The oscillator belt is not adjustable. If the belt shows cracks or is slipping, replace the belt with a new one.

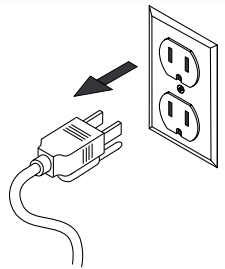

WARNING

MAKE SURE your machine is unplugged during all assembly, adjustments, or maintenance procedures. Otherwise serious personal injury may occur!

To adjust the drive belt tension, do these steps:

1. **UNPLUG THE DRILL PRESS!**
2. Open the belt cover. See **Figure 15**.
3. Loosen the motor lock screw at the side of the headstock. See **Figure 16**.
4. Gently pivot the motor away from the pushrod rubber until the belt is taut.
5. Hold the motor in position so the rubber pad is held against the motor.
6. Tighten the lock screw, and make sure the belt deflection gap is correct when pinched together between the pulleys. See **Figure 17**.
 - If the gap between both inner sides of the belt is greater or less than 1½" repeat **Steps 3** through **6** until the deflection gap is 1½".
 - If the deflection gap is 1½," close the belt cover until it snaps shut. **The motor will not start until the cover is closed.**

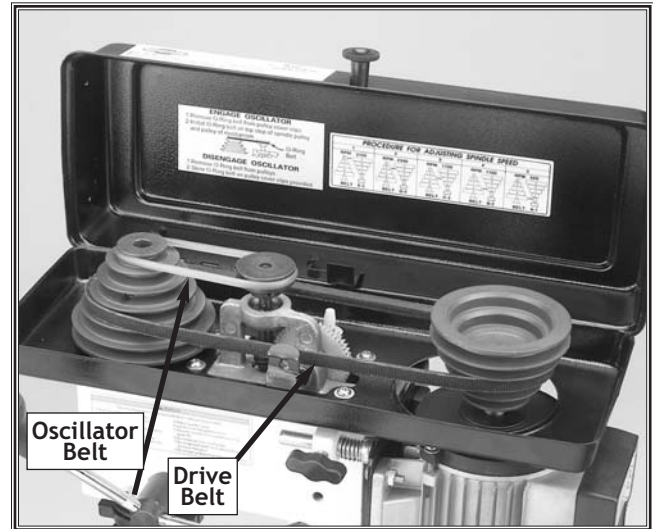

Figure 15. Belt drive system.

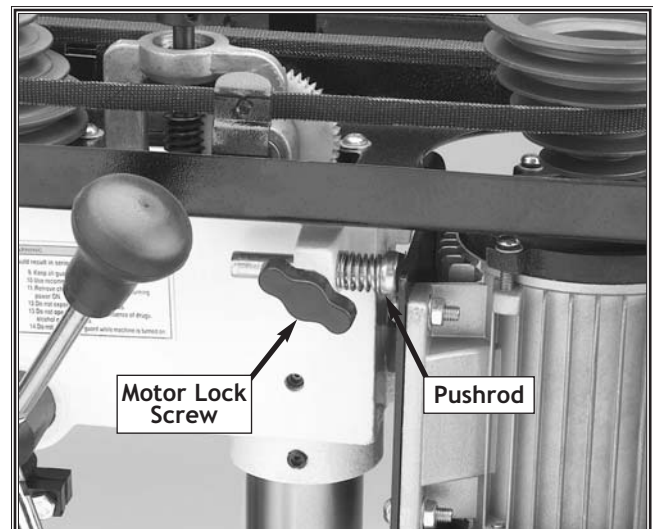

Figure 16. Motor lock screw.



Figure 17. Measuring belt deflection.

Feed Shaft Spring Tension

The feed shaft return spring is adjusted at the factory; however, during the life of the drill press you may want to adjust the feed shaft return spring at a stronger return pressure.

	<p>⚠ WARNING MAKE SURE your machine is unplugged during all assembly, adjustments, or maintenance procedures. Otherwise serious personal injury may occur!</p>
--	---

	<p>⚠ WARNING WEAR safety glasses when adjusting springs. Serious injury may occur if this warning is ignored!</p>
--	--

To adjust the feed shaft spring tension, do these steps:

1. **UNPLUG THE DRILL PRESS!**
2. Wipe off any oil on the spring lock cover so it will not slip in your fingers when you hold the cover from spinning. See **Figure 18**.
3. Make sure the quill shaft is completely seated and the depth stop reads "0". See **Figure 19**.
4. Put on thick leather gloves and hold the spring cover against the side of the headstock so the cover stays splined with the locking lug; remove the jam nut and loosen the cover nut approximately $\frac{1}{4}$ " (6.4mm). See **Figure 19**.
5. Pull the cover outward just enough to disengage the spring-cover lock slot from the locking lug. See **Figure 20**.
6. Rotate the cover counter clockwise to increase spring tension, or let the cover slowly unwind in the clockwise direction to reduce spring tension. See **Figure 20**.

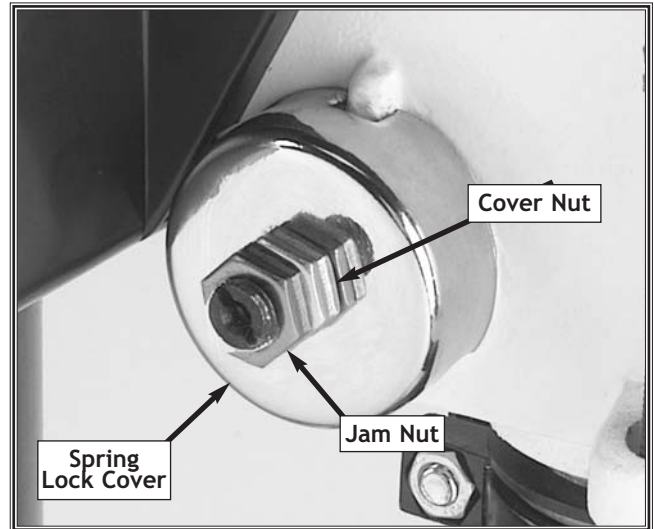

Figure 18. Feed shaft return spring assembly.

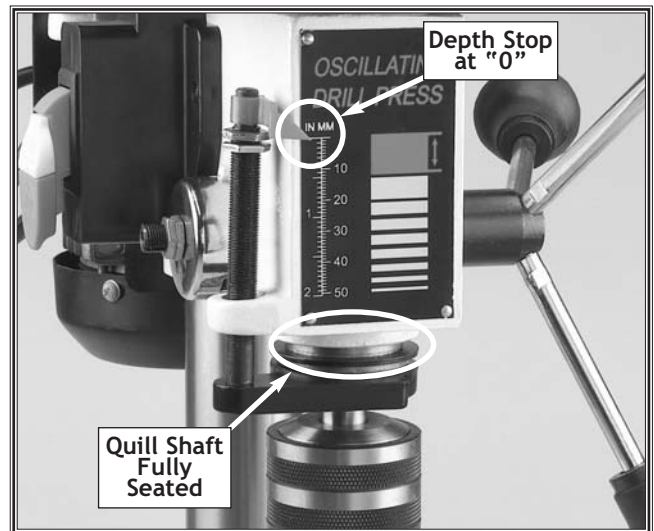

Figure 19. Quill shaft fully seated.

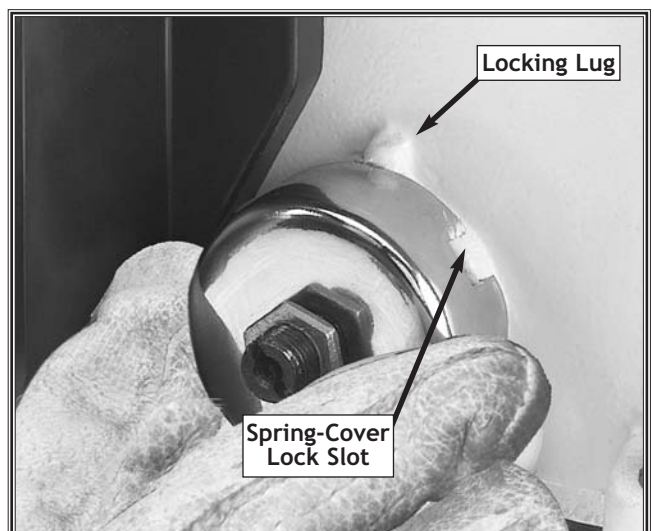
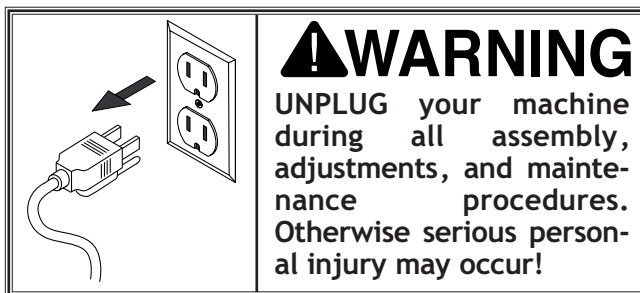

Figure 20. Typical spring cover lock slot and locking lug.

7. Engage the next available spring-cover lock slot with the locking lug, and hold the spring lock cover tightly against the side of the headstock. See **Figure 21**.
8. Snug the cover nut against the spring cover just until the nut stops, and then back-off the nut approximately $\frac{1}{3}$ turn, or just enough so there is no binding anywhere along complete spindle travel.
9. Hold the cover nut and tighten the jam nut against the cover nut. See **Figure 21**.

Quill-Shaft Screw

While you may never have to adjust the quill-shaft screw, you should understand its function and know how to adjust it should you ever need to remove the quill for cleaning. This screw prevents the quill from rotating during drilling and sanding procedures, and if adjusted incorrectly, the quill may have lash or bind.



To adjust the quill-shaft screw, do these steps:

1. Unplug the drill press.
2. Clean and lubricate the quill shaft with a thin coat of light oil, and make sure the quill travels freely. See **Figure 22**.
3. Loosen the jam nut. See **Figure 23**.
4. Turn the quill-shaft screw clockwise or counterclockwise to establish free, unbinding travel while moving the quill up and down through its entire range of travel.
5. When the quill-shaft screw is screwed inward against the quill as far as the screw can go without binding the quill, hold the screw and tighten the jam nut.
6. Recheck for quill binding and looseness while moving the quill up and down through its entire range of travel and re-adjust as required.



Figure 21. Hold the spring cover tightly.



Figure 22. Clean and oil quill shaft.

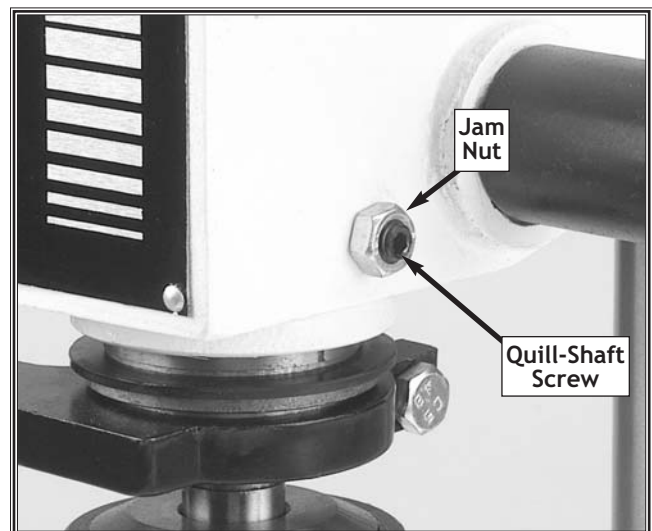
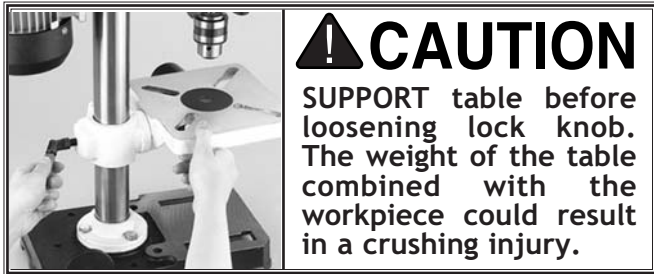

Figure 23. Typical quill-shaft screw and jam nut.

Table Height / Tilt

You can adjust the table height and angle to accommodate for workpiece height or achieve special drilling/sanding angles. You can also move the table out of the way and use the drill press base as a table for drilling/sanding.



To adjust the table, do these steps:

1. Hold onto the table with one hand and loosen the table lock knob. See **Figure 24**.
2. Lift or lower the table to the desired height, and then position the table so the opening in the installed table insert is centered to the drill bit or sanding drum.
 - If the table is not needed, pivot the table to the back side of the column so you can support the workpiece on the base (drilling operations only). See **Figure 25**.
3. Tighten the table lock knob.
4. Loosen the table tilt lock bolt and use the tilt scale to find your desired drilling or sanding angle. See **Figure 26**.
5. Tighten the tilt table lock bolt.



Figure 24. Support table while loosening lock.



Figure 25. Table adjusted behind column.

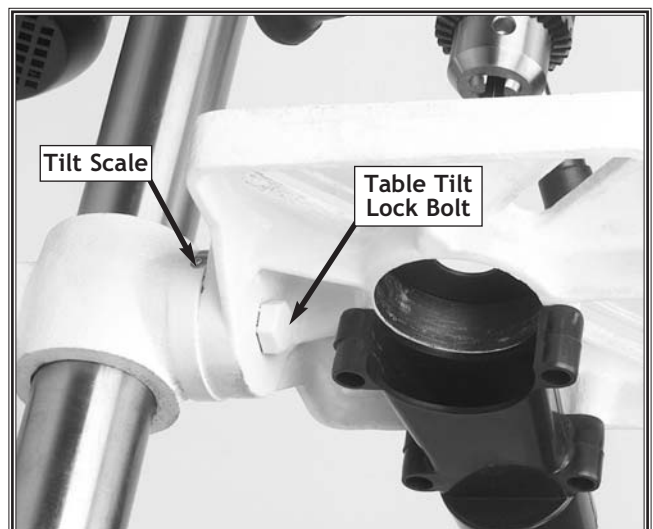
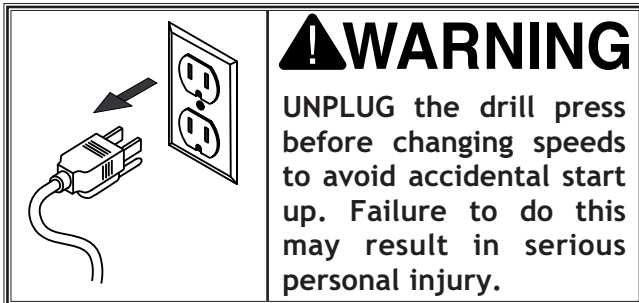

Figure 26. Table tilt lock bolt.

Drilling Speed

The Model W1667 8 1/2" Oscillating Drill Press has 5 speeds ranging from 620 to 3100 RPM. Refer to the speed charts located under the belt guard while following the instructions below.



To change the drilling speed, do these steps:

1. **UNPLUG THE DRILL PRESS!**
2. Refer to the speed chart located under the belt cover or refer to the "Drill Press RPM Chart" on Page 18 and choose the desired speed.
3. Loosen the v-belt tension lock. See Figure 27.
4. Pull the motor toward the front of the drill press to remove tension from the V-belt.
5. Move the V-belt to the desired V-grooves on the motor and spindle pulleys. See Figure 28.
6. Push the motor toward the back of the headstock, the motor pushrod rod is spring loaded and will follow the motor. See Figure 29.
7. Tighten the lock knob.
8. Tighten the lock screw, and make sure the belt deflection is 1 1/2" between both inner sides when the belt is pinched together between the pulleys. Refer to "Belt Tension" in the ADJUSTMENTS section on Page 13 for details.
9. Close the cover. **The motor will not start until the cover is closed.**



Figure 27. Loosening the lock knob.



Figure 28. Adjusting belt to desired speed.

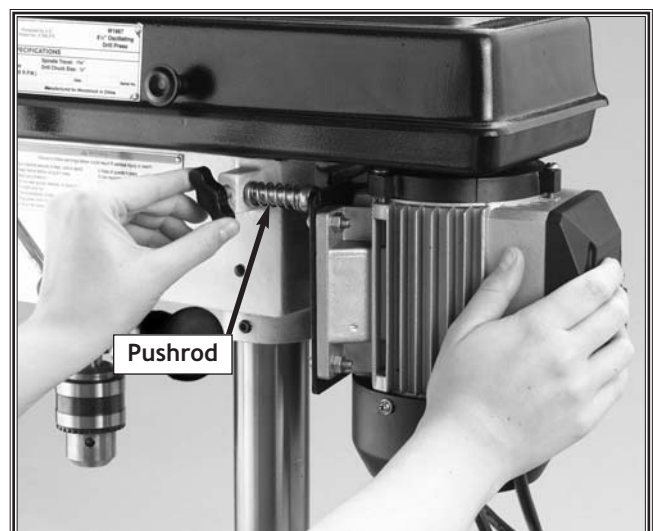

Figure 29. Motor support rod follows motor.

Drill Press RPM Chart

Use **Figure 30** to select the optimum motor-to-spindle pulley ratio for drilling, cutting, and sanding operations. Refer to the **Drill, Cutter, and Saw RPM Chart** on **Page 19** for suggested tool RPMs.

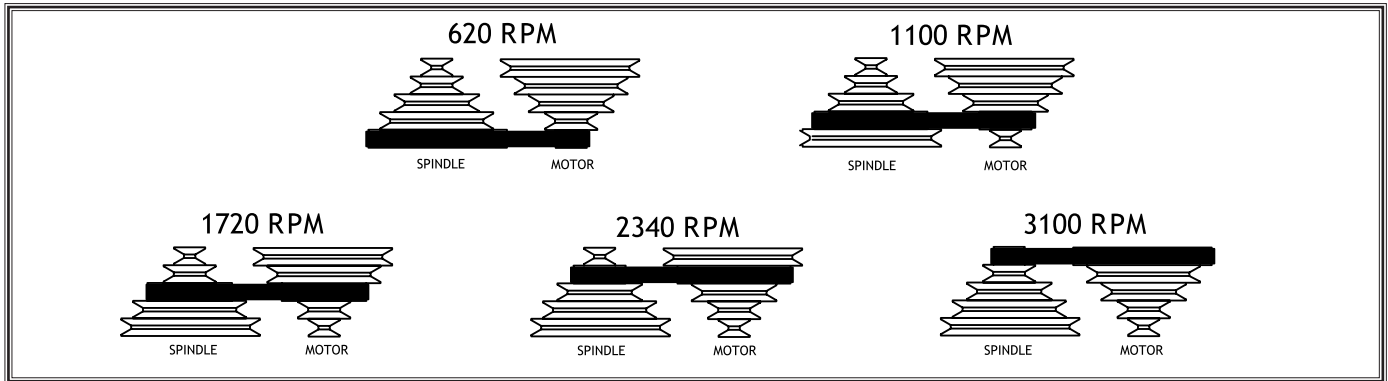

Figure 30. Drill Press RPM Chart.

Drilling Depth

Your new drill press comes fitted with a depth stop that allows drilling holes at a preset depth.

NOTICE

BACK-OFF the depth stop completely and secure the stop nuts before using the oscillating feature. If the depth stop is left adjusted for a shallow hole, or the nuts rattle down to the stop while in operation, the depth stop will bottom out and break the oscillator.

To adjust the drilling depth, do these steps:

1. **UNPLUG THE DRILL PRESS!**
2. Rotate the oscillator pulley until the depth stop pointer indicates "0". See **Figure 30**.
3. Loosen the jam nut on the depth stop rod.
4. Move the spindle down while watching the pointer-to-scale relationship and stop at the desired depth.
5. Turn the lower nut while maintaining this depth until the nut comes into contact with the stop flange. See **Figure 31**.
6. Allow the spindle to return to its original position and tighten the jam nut against the stop nut while making sure the stop nut does not move.
7. Drill a test hole into scrap stock before drilling into any workpiece, and readjust depth stop if necessary.

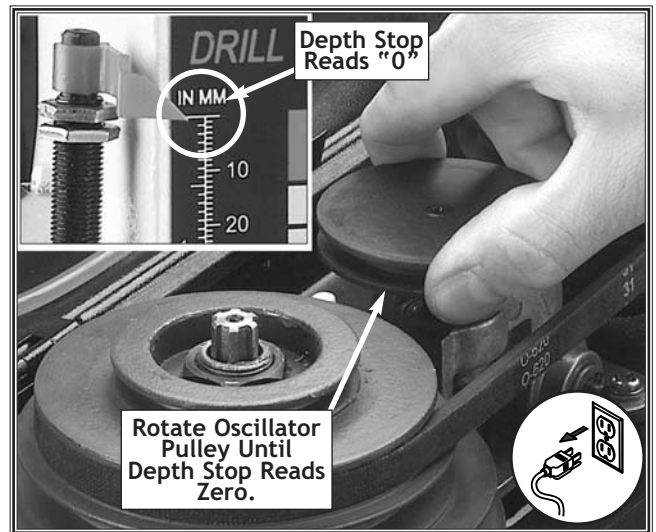

Figure 30. Retracting the oscillator for drilling.

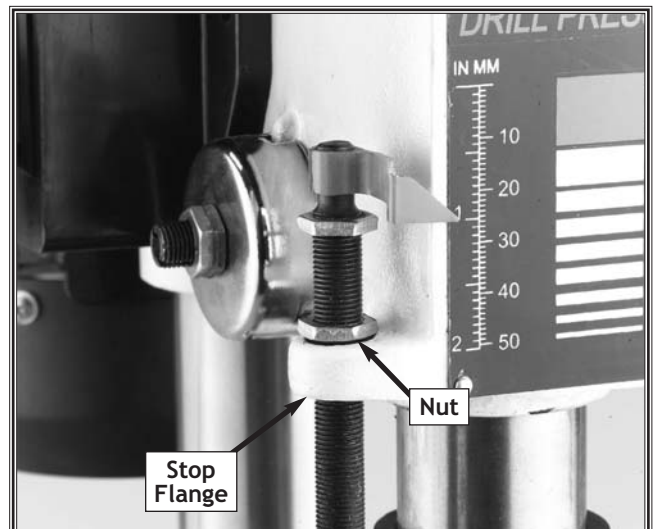

Figure 31. Nut contacting stop flange.

Drill, Cutter, and Hole Saw Suggested RPM Chart

ALWAYS follow the drill, saw, or cutter manufacturer's recommended RPM specifications. **ALWAYS** wear safety glasses. **DO NOT** use your drill press to exceed the drilling, cutting, or sawing RPM or the feed rate of your bit or cutter. Otherwise serious personal injury can occur.

The RPMs listed below are merely suggestions to help you use your drill press in the event that you cannot find a basic starting RPM point. The final RPMs may differ based on the material drilled, the pressure you apply, and the cut-quality needed. Remember, even if the RPM and all other settings are correct, cooling the tool with a lubricant and drilling a pilot hole may also be required. Refer to **WARNINGS** and **TIPS**, trade journals, training manuals, and other educational resources for in-depth instructions and safety knowledge.

For current product line, refer to: <http://www.steelix.biz/drilling.cfm>.

Sanding Sleeves or Grinding Bits	Soft Wood	Hard Wood	Plastic	Brass	Aluminum	Mild Steel
1", 1-1/2", 2"	2000	1725	1000	3100	3100	3100
Twist Type Drill Bits: (Wood, Plastic, and Metal)						
1/16" to 3/16"	3000	3000	2500	3000	3000	3000
1/4" to 3/8"	3000	1500	2000	1200	2500	1000
7/16" to 5/8"	1500	750	1500	750	1500	600
11/16" to 1"	750	500	-	400	1000	350
Spade Drill Bits: (Wood)						
1/4" to 1/2"	2000	1500	-	-	-	-
5/8" to 1"	1750	1500	-	-	-	-
1-1/8" to 1-1/2"	1500	1000	-	-	-	-
Spade with Spur Drill Bits: (Wood and Plastic)						
3/8" to 1"	2000	1800	500	-	-	-
Brad Point Drill Bits: (Wood and Plastic)						
1/8"	1800	1200	1500	-	-	-
1/4"	1800	1000	1500	-	-	-
3/8"	1800	750	1500	-	-	-
1/2"	1800	750	1000	-	-	-
5/8"	1800	500	750	-	-	-
3/4"	1400	250	750	-	-	-
7/8"	1200	250	500	-	-	-
1"	1000	250	250	-	-	-
Forstner Drill Bits: (Wood and Plastic)						
1/4" to 11/16"	2400	1600	250	-	-	-
3/4" to 1-1/16"	1800	1200	250	-	-	-
1-1/8" to 1-7/16"	1200	800	250	-	-	-
1-1/2" to 2-1/8"	600	450	-	-	-	-
2-1/4" to 3-1/8"	480	250	-	-	-	-
Multi-Spur Drill Bits: (Wood)						
2-1/8" to 4"	250	250	-	-	-	-
Countersink Cutters: (Wood, Plastic, and Metal)						
2-Flute Cutter	1400	1400	-	-	-	-
5-Flute Cutter	1000	750	750	250	250	250
Plug Cutters: (Wood)						
3/8" to 1/2"	1200	1000	-	-	-	-
5/8" to 1"	800	600	-	-	-	-
Carbide Rosette Cutters: One-Piece Shear Type (Wood)						
2-1/2" to 3"	1800	500	-	-	-	-
Rosette Cutters: Replaceable Carbide-Knife Type (Wood)						
2-1/4" to 3-1/8"	350	250	-	-	-	-

WARNINGS and TIPS

- **WARNING:** The larger the drill bit or hole saw and the slower the RPM, the greater the chance the tool could aggressively grab the workpiece, damage the tool and workpiece and cause injury. High RPMs can melt plastic, burn wood, and dull the tool.
- **WARNING:** Use a 5-Flute cutter when cutting into plastics, brass, aluminum, and mild steel. A 2-Flute cutter can aggressively grab the workpiece and damage the tool.
- **TIP:** To increase the life of drill bits, cutters, hole saws, and improve cut quality, use a lubricant equivalent to these:
 - Plastics:** use a soapy-water lubricant
 - Brass:** use a water-based lubricant
 - Mild Steel:** use an oil-based lubricant
 - Aluminum:** use a paraffin-based lubricant
 - Cast Iron:** use a pipe-thread cutting lubricant
 - Wood:** use no lubricant.
- **TIP:** Raise the drill bit, cutter, or hole saw often to clear chips and cool the tool.
- **TIP:** When drilling plastics with spade bits, use a spade bit with spurs.
- **TIP:** Plug cutters and rosette cutters are for wood only; however, carbide-tipped bits and cutters cut at a higher RPM, and can cut materials other than wood depending on cutter type. Carbide makes better cuts and lasts longer than HSS steel.
- **TIP:** When using hole saws, apply firm and even pressure, so the saw teeth contact the surface all at the same time-not at an angle. You can also flip the workpiece and finish drilling from the other side.
- **TIP:** To prevent drill bit wandering, use a center punch to start the drill bit.

ADJUSTMENTS

Saws: Bi-Metal Hole Saws (Most Materials)															
Hole Saw Diameter	Soft Wood	Hard Wood	Plastic	Mild Steel	Cast Iron	Brass	Aluminum	Hole Saw Diameter	Soft Wood	Hard Wood	Plastic	Mild Steel	Cast Iron	Brass	Aluminum
9/16"	1150	870	1320	580	400	790	900	2-7/8"	240	180	275	120	80	160	180
5/8"	1100	825	1250	550	365	730	825	3"	230	170	260	115	75	150	170
11/16"	1000	750	1140	500	330	665	750	3-1/16"	220	165	250	110	75	150	170
3/4"	920	690	1050	460	300	600	690	3-1/8"	220	165	250	110	70	140	165
13/16"	850	635	970	425	280	560	635	3-3/16"	210	155	240	105	70	140	165
7/8"	780	585	890	390	260	520	585	3-1/4"	210	155	240	105	70	140	155
15/16"	740	555	845	370	245	495	555	3-5/16"	200	150	225	100	70	130	155
1"	700	525	800	350	235	470	525	3-3/8"	200	150	225	100	65	130	150
1-1/16"	650	480	740	325	215	435	480	3-7/16"	200	150	225	100	65	130	150
1-1/8"	600	450	685	300	200	400	450	3-1/2"	190	140	215	95	65	130	145
1-3/16"	570	430	650	285	190	380	425	3-9/16"	190	140	215	95	65	120	145
1-1/4"	550	410	625	275	180	360	410	3-5/8"	190	140	215	95	60	120	140
1-5/16"	520	390	595	260	175	345	390	3-11/16"	180	135	205	90	60	120	140
1-3/8"	500	375	570	250	165	330	375	3-3/4"	180	135	205	90	60	120	135
1-7/16"	480	360	545	240	160	315	360	3-13/16"	180	135	205	90	60	120	135
1-1/2"	460	345	525	230	150	300	345	3-7/8"	180	135	205	90	60	120	135
1-9/16"	440	330	500	220	145	290	330	4"	170	130	195	85	55	110	130
1-5/8"	420	315	475	210	140	280	315	4-1/16"	170	130	195	85	55	110	120
1-11/16"	410	310	465	205	130	260	295	4-1/8"	160	120	180	80	55	110	120
1-3/4"	390	290	445	195	130	260	295	4-3/16"	160	120	180	80	55	110	120
1-13/16"	380	285	435	190	125	250	285	4-1/4"	160	120	180	80	55	100	120
1-7/8"	360	270	400	180	120	240	270	4-5/16"	160	120	180	80	55	100	120
2"	340	255	385	170	115	230	255	4-3/8"	160	120	180	80	50	100	120
2-1/16"	330	245	375	165	110	220	245	4-7/16"	150	110	170	75	50	100	105
2-1/8"	320	240	365	160	105	210	240	4-1/2"	150	110	170	75	50	100	105
2-3/16"	310	230	355	155	105	205	240	4-9/16"	150	110	170	75	50	95	100
2-1/4"	300	225	340	150	100	200	225	4-5/8"	150	110	170	75	50	95	100
2-5/16"	290	215	330	145	100	195	225	4-11/16"	150	110	170	75	50	95	100
2-3/8"	280	210	320	140	95	190	220	4-3/4"	150	110	170	75	50	95	95
2-7/16"	280	210	320	140	95	185	210	4-13/16"	130	100	150	65	45	90	95
2-1/2"	270	200	310	135	90	180	205	4-7/8"	130	100	150	65	45	90	90
2-9/16"	270	200	310	135	85	175	200	5"	130	100	150	65	45	90	90
2-5/8"	260	195	295	130	85	170	195	5-1/4"	120	90	135	60	40	85	85
2-11/16"	260	195	295	130	85	165	190	5-1/2"	120	90	135	60	40	85	85
2-3/4"	250	185	285	125	80	160	185	5-3/4"	110	80	125	55	35	75	75
2-13/16"	250	185	285	125	80	160	185	6"	110	80	125	55	35	75	75

OPERATIONS

Starting the Drill Press

Once assembly is complete and adjustments are done to your satisfaction, you are ready to start the drill press. Every time you start the drill press, you should follow these basic instructions.

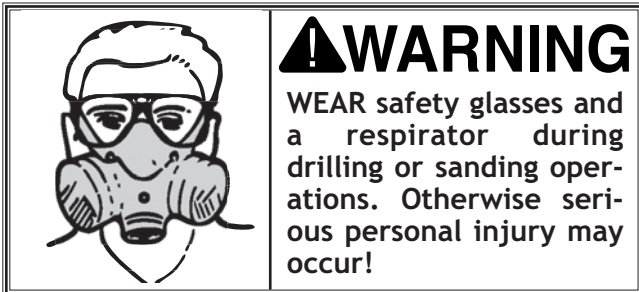

To start the drill press, do these steps:

1. Make sure the starting switch paddle is down for **OFF**.
2. Make sure all fasteners and lock handles are tight.
3. Make sure the drill chuck key is removed.
4. Plug in the power cord.
5. Lift the **ON/OFF** switch to start the drill press, and make sure that your finger is poised over the paddle, as shown in **Figure 32**, just in case there is a problem.
6. Listen and observe the drill press, it should run smoothly, with little or no vibration or rubbing noises.
 - If you hear strange or unusual noises, shut the drill press **OFF**, and wait for the spindle to stop moving.
7. Unplug the drill press and refer to the "Troubleshooting" table on **Page 26** to help isolate and correct the problem before using the drill press again.



Figure 32. Hand poised over a typical stop switch.

Drill/Drum Changes

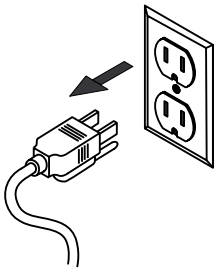

⚠ WARNING

NEVER troubleshoot or adjust the machine while it is running. Wait until the machine is turned off, unplugged and all working parts have come to a stop before proceeding!

To change drill bits and sanding drums, do these steps:

1. UNPLUG THE DRILL PRESS!
2. Use the chuck key to open the chuck wide enough to accept the new bit or the sanding drum mandrel. See Figure 33.
3. Install the bit or mandrel so the chuck jaws will grab as much of the bit or mandrel shank as it can.
 - If you are installing a small drill bit, make sure it is held between three jaws instead of only two, and NEVER allow a chuck to grab the fluted body of drill bits.
 - If you are installing the sanding drum, install the paper and drum before installing the spindle into the drill chuck (contact your local SHOP FOX® dealer for drums and paper).
4. Tighten the chuck with the chuck key, using any of the three key end locations. See Figure 34.
5. Choose the insert that has an opening approximately 1/4" bigger than the sanding drum chosen. For drilling, always use the table insert with the smallest opening. A table insert is not needed when a 2" drum is used. See Figure 35.
6. Install the chosen table insert into the pocket in the top of the table.
7. Remove the chuck key and reconnect the power source.
8. Reverse these steps to remove the drill bit or sanding drum.



Figure 33. Installing bit.

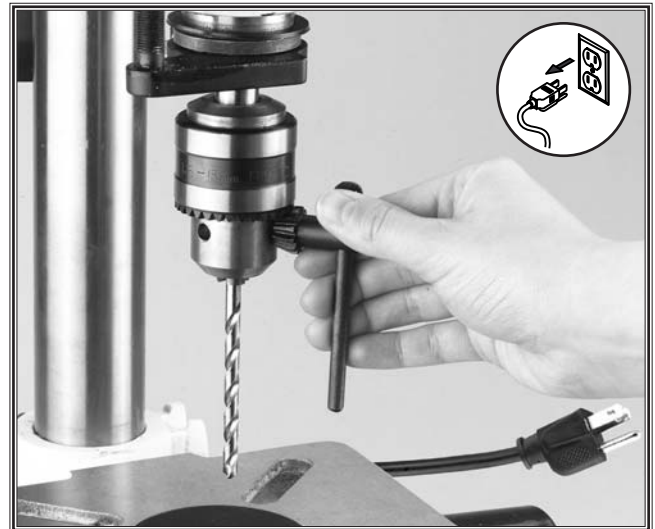



Figure 34. Chuck key engaged.



Figure 35. Sanding drum table insert.

Using the Oscillator

One of the great features of the Model W1667 8 1/2" Oscillating Drill Press is its sanding capability. The drill press can be converted from drilling operations to sanding operations in just a few steps.



⚠ WARNING
UNPLUG the machine and remove all handles before using the oscillating feature. The handles swing during operation.

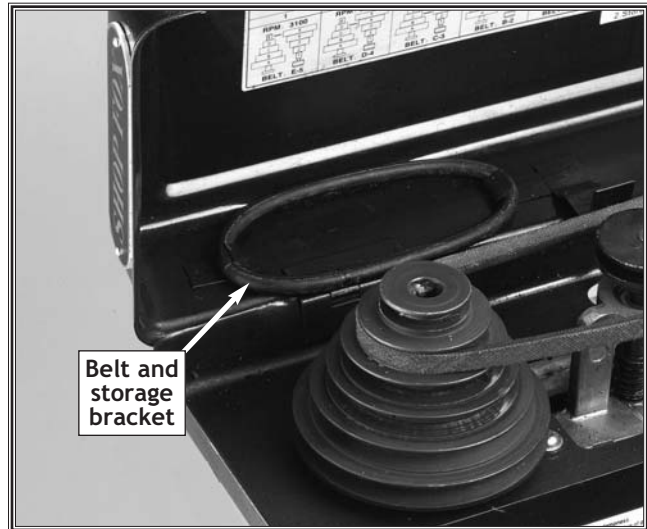

Figure 36. Oscillator belt on storage bracket.

To use the oscillating feature, do these steps:

1. **UNPLUG THE DRILL PRESS!**
2. Remove the spindle handles.
3. Lift the belt cover and remove the round belt located on the storage bracket under the speed chart. See Figure 36.
4. Stretch the belt onto the top groove in the spindle and oscillating pulley. See Figure 37.
5. Close the cover. The motor will not start until the cover is closed.
6. Loosen the jam nut for the depth stop and adjust both nuts until they are positioned at the top of the depth stop rod. Tighten the jam nut. See Figure 38.



Figure 37. Stretch the belt to fit on pulleys.

NOTICE

ALWAYS back-off the depth stop completely and secure the depth stop nuts before using the oscillating feature. If the depth stop is left adjusted for a shallow hole, or the nuts rattle down to the stop while in operation, the depth stop will bottom out and break the oscillator.



Figure 38. Back-off the depth stop nuts.

7. Choose the insert that has an opening which is slightly bigger than the sanding drum chosen. See **Figure 39**.
8. Insert the sanding drum mandrel into the chuck and set the chosen table insert into the pocket in the top of the table. See **Figure 40**.
 - For general drill bits, small reamers, and miscellaneous small cutting and sanding bits, use the $\frac{5}{8}$ " and the 1" table inserts.
 - For the 1" sanding drum, use the $1\frac{3}{8}$ " table insert.
 - For the $1\frac{1}{2}$ " sanding drum, use the $1\frac{7}{8}$ " table insert.
 - For the 2" sanding drum, use no table insert.
9. Loosen and pivot the table so the opening in the installed table insert is centered to the drill bit or sanding drum.



Figure 39. Sanding drum table insert.

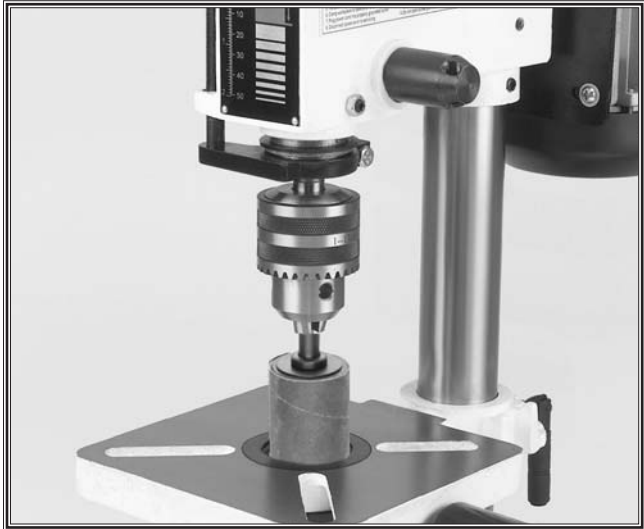



Figure 40. Sanding drum installed.



⚠ CAUTION

NEVER sand or drill without the table in position and the workpiece secured. Serious personal injury may occur.

10. Adjust the table height to use all of the grit on the paper as the paper wears.
 - If the thickness of the workpiece does not allow much table movement and the sanding drum paper is partially worn on one end, remove the drum from the sanding spindle, turn it end for end and replace it on the sanding spindle to use the newer part of the sandpaper.
11. Turn the drill press **ON**, and begin sanding.

MAINTENANCE

General

Periodic maintenance on your Model W1667 8 1/2" Oscillating Drill Press will ensure its optimum performance. Make a habit of inspecting your drill press after each use.

	<p>⚠ WARNING</p> <p>NEVER adjust or service the machine while it is running. Wait until the machine is turned off, unplugged and all working parts have come to a stop before proceeding!</p>
--	--

Check for the following conditions and repair or replace when necessary.

1. Loose mounting bolts.
2. Worn switch.
3. Worn or damaged cords and plugs.
4. Damaged drive belts.
5. Any other condition that could hamper the safe operation of this machine.

Lubrication

Since all bearings are shielded and permanently lubricated, simply leave them alone until they need to be replaced. Do not lubricate them.

For other items on this machine, such as the quill, table and column, an occasional application of light machine oil is all that is necessary. Before applying lubricant, clean off sawdust and metal chips.

Your goal is to achieve adequate lubrication. Too much lubrication will attract dirt and sawdust. Various parts of your machine could lose their freedom of movement as a result.

Table and Base

Keep the table and other unpainted surfaces rust-free with regular applications of products like Boeshield® T-9. For long term storage consider products like Kleen Bore's Rust Guardit™.

Sanding Sleeves

As sanding drums are used, the abrasive sleeve will quickly become "loaded" with sawdust. If not removed, this sawdust will harden on the abrasive surface, rendering the sleeve useless. Routinely clean the sanding sleeve with a rubber gum abrasive cleaner like the PRO-STIK® cleaners as shown on Page 33.

Always discard worn sanding sleeves. As abrasive sleeves begin to wear, grit will begin to fall off and cause gouges in the workpiece. Glue used to hold the grit to the paper will rub off onto the workpiece interfering with the final finish.

NOTICE

Contrary to some beliefs, worn abrasives are not the equivalent the next finer grit abrasive. Discard worn sanding sleeves and avoid the temptation to use them beyond their usable life.

Troubleshooting

Use this table to isolate and correct any problems with your drill press. If you cannot correct a problem, contact Woodstock International, Inc. at 1-360-734-3482 or tech-support@shopfox.biz.

SYMPTOM	POSSIBLE REASON	HOW TO REMEDY
The drill press does not start.	<ol style="list-style-type: none"> 1. The pulley cover is not closed. 2. The power supply circuit breaker is tripped. 3. The power supply cord is damaged or has a poor connection. 4. The drill press power switch is at fault or is missing the yellow safety key. 5. The belt cover safety switch is at fault. 6. The motor is at fault. 	<ol style="list-style-type: none"> 1. Make sure there are no obstructions and close the pulley cover. 2. Get a qualified electrician to troubleshoot and correct the cause for the circuit breaker or fuse trip. 3. Make sure all connections are good, and replace the power supply cord if damaged. 4. Insert the safety key, and/or replace the power switch. 5. Replace the safety switch; do not repair it. 6. Replace the motor.
Drilling stops, but the motor still operates.	<ol style="list-style-type: none"> 1. The belt is loose or worn. 2. The pulley for the spindle shaft or the motor is slipping on the shaft. 	<ol style="list-style-type: none"> 1. Replace and/or adjust the belt. 2. To resecure the pulley, do these steps: <ol style="list-style-type: none"> a. UNPLUG THE DRILL PRESS. b. Remove the setscrew on the slipping pulley. c. Align the flat spot on the pulley shaft with the setscrew hole. d. Reinstall and tighten the setscrew.
The chuck wobbles or is loose on the spindle shaft.	<ol style="list-style-type: none"> 1. The chuck-retaining bolt is loose or missing. 2. Foreign material is stuck between the chuck-to-spindle mating surface. 	<ol style="list-style-type: none"> 1. Install and tighten a new chuck-retaining bolt. 2. Remove the chuck and clean and de-burr the tapered chuck and spindle mating surfaces, then reassemble.
The drill press does not oscillate.	<ol style="list-style-type: none"> 1. The oscillator belt is broken. 2. The oscillation mechanism is at fault. 	<ol style="list-style-type: none"> 1. Replace and/or adjust the belt. 2. Remove the oscillating mechanism and replace the broken parts.
The spindle does not retract completely in the uppermost position or it binds.	<ol style="list-style-type: none"> 1. The oscillator is not in the parked position. 2. The quill shaft is gummy with sawdust and oil. 3. The feed shaft return spring is weak. 4. The quill deflection screw is binding the quill. 	<ol style="list-style-type: none"> 1. Open the belt cover and rotate the oscillator pulley until the quill is fully seated up into the headstock, indicating the oscillator is parked. 2. Clean the gummy substance with penetrating oil and lubricate with a light coat of oil. 3. Increase the feed shaft return spring tension. 4. Loosen the jam nut, and slightly turn out the screw where the quill binds. Retighten the jam nut and recheck for binding and looseness at all spindle locations.
The quill has excessive deflection.	<ol style="list-style-type: none"> 1. The quill shaft is at fault. 2. The quill and/or bearings are worn. 	<ol style="list-style-type: none"> 1. Adjust the quill screw as described on Page 15. 2. Replace the quill and/or bearings.

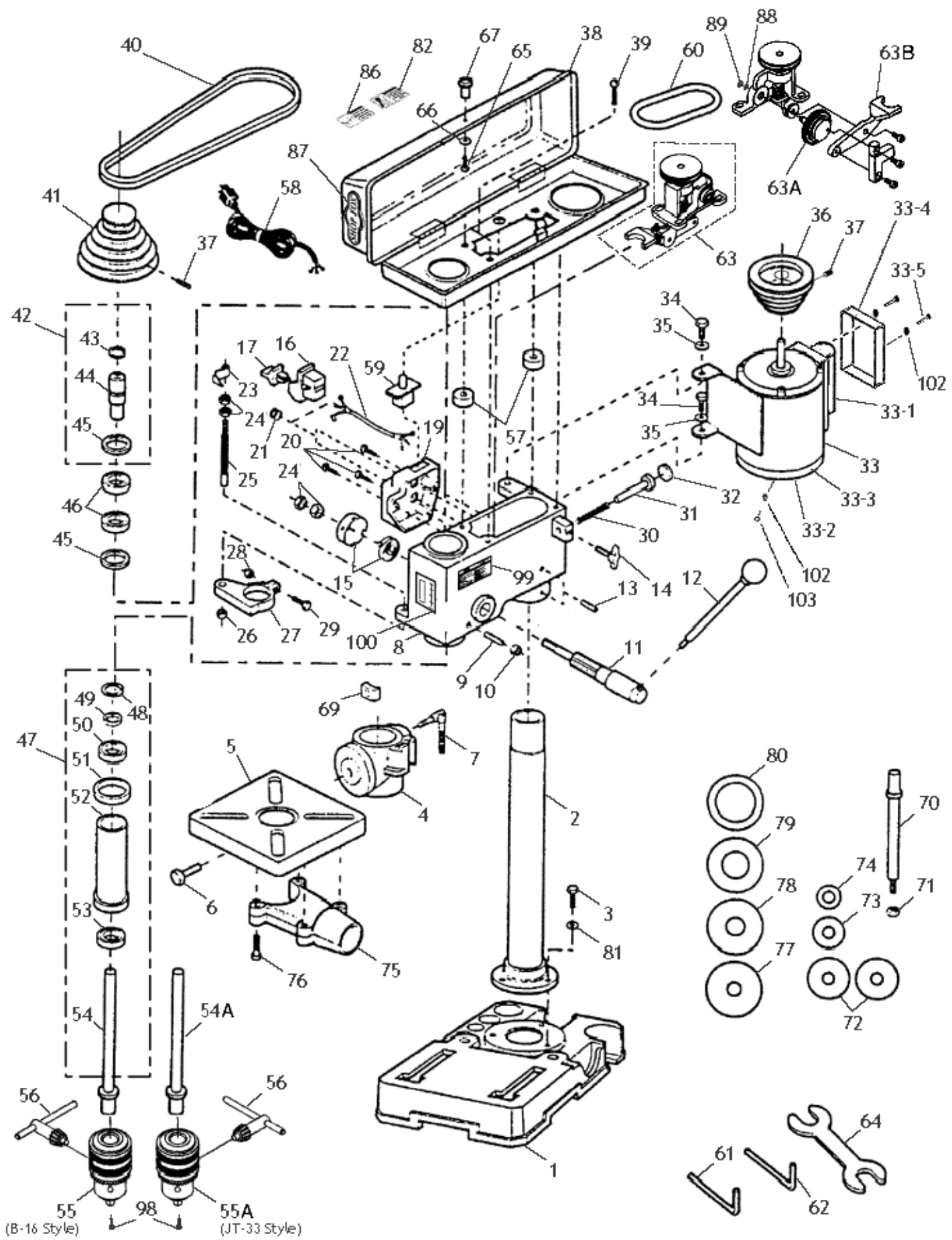

55 (B-16 Style) 98 55A (JT-33 Style)

REF	PART #	DESCRIPTION
1	X1667001	BASE
2	X1667002	COLUMN
3	XPB09M	HEX BOLT M8-1.25 X 20
4	X1667004	TABLE BRACKET
5	X1667005	TABLE
6	XPB25M	HEX BOLT M12-1.75 X 25
7	X1667007	LOCK HANDLE M10
8	X1667008	HEAD CASTING
9	X1667009	SPECIAL DEFLECTION SCREW
10	XPN01M	HEX NUT M6-1.0
11	X1667011	FEED SHAFT
12	X1667012	HANDLE BAR
13	XPSS25M	SET SCREW M6-1.0 X 18
14	X1667014	THUMB SCREW
15	X1667015	RETURN SPRING ASSY.
16	X1666009	SWITCH
17	XPSW09	SWITCH KEY
19	X1667019	SWITCH COVER
20	XPS32M	PHLP HD SCR M4-.7 X 10
21	X1667021	STRAIN RELIEF
22	X1667022	SWITCH CORD
23	X1667023	DEPTH STOP POINTER
24	XPN14M	HEX NUT M10-1.0
25	X1667025	DEPTH STOP ROD
26	XPN03M	HEX NUT M8-1.25
27	X1667027	DEPTH ROD BRACKET
28	XPN01M	HEX NUT M6-1.0
29	XPB10M	HEX BOLT M6-1.0 X 25MM
30	X1667030	SPRING
31	X1667031	PUSH ROD
32	X1667032	RUBBER PAD
33	X1667033	MOTOR 1/2 HP, 110V
33-1	X1667033-1	S. CAPACITOR 300V 24M
33-2	X1667033-2	FAN
33-3	X1667033-3	FAN COVER
33-4	X1667033-4	MOTOR BOX COVER
33-5	X1667033-5	MOTOR BOX COVER SCREW
34	XPB03M	HEX BOLT M8-1.25 X 16
35	XPW01M	FLAT WASHER M8
36	X1667036	MOTOR PULLEY
37	XPSS01M	SET SCREW M6-1.0 X 10MM
38	X1667038	PULLEY COVER
39	XPS22M	PHLP HD SCR M6-1.0 X 20
40	X1667040	V-BELT
41	X1667041	SPINDLE PULLEY
42	X1667042	DRIVE SLEEVE ASSY (43-45)
43	XPR08M	EXT RETAINING RING 19MM
44	X1667044	SLEEVE (SQUARE SPLINED)
44A	X1667044A	SLEEVE (ROUND SPLINED)
45	XPR34M	INT RETAINING RING 40MM

REF	PART #	DESCRIPTION
46	XP6203	BALL BEARING 6203
47	X1667047	QUILL ASSEMBLY (48-54)
48	XPR48	EXT RETAINING RING 11MM
49	X1667049	COLLAR
50	XP6201	BALL BEARING 6201
51	X1667051	COLLAR
52	X1667052	QUILL
53	XP6201	BALL BEARING 6201
54	X1667054	SPINDLE SHAFT (B-16 STYLE)
54A	X1667054A	SPINDLE SHAFT (JT-33 STYLE)
55	X1667055	CHUCK (B-16 STYLE)
55A	X1667055A	CHUCK (JT-33 STYLE)
56	X1667056	CHUCK KEY
57	X1667057	COVER SPACER
58	X1667058	POWER CORD
59	X1667059	SAFETY SWITCH
60	X1667060	OSCILLATOR BELT
61	XPAW03M	3MM HEX WRENCH
62	XPAW04M	4MM HEX WRENCH
63	X1667063	OSCILLATING MECHANISM ASSY.
63A	X1667063A	PLASTIC RING GEAR
63B	X1667063B	OSCILLATING MECH. ARM
64	X1667064	14MM X 1/2" WRENCH
65	XPS22M	PHLP HD SCR M5-.7 X 14
66	XPW02M	FLAT WASHER M5
67	X1667067	COVER KNOB M5-.7
69	X1667069	LOCK SHOE
70	X1667070	MANDREL
71	X1PN30M	HEX NUT M8-1.25
72	X1667072	MANDREL WASHER 1 3/4"
73	X1667073	MANDREL WASHER 7/8"
74	X1667074	MANDREL WASHER 5/8"
75	X1667075	DUST PORT (2PC)
76	XPS33M	PHLP HD SCR M4-0.7 X 22
77	X1667077	TABLE INSERT 5/8"
78	X1667078	TABLE INSERT 1"
79	X1667079	TABLE INSERT 1 5/8"
80	X1667080	TABLE INSERT 1 7/8"
81	XPW01M	FLAT WASHER M8
82	X1667082	LABEL (LONG HAIR SAFETY)
86	X1667086	LABEL (SAFETY GLASSES)
87	X1667087	LABEL (SHOP FOX)
88	XPW01M	FLAT WASHER M8
89	XPR36M	EXT RETAINING RING 7MM
98	XPSB15M	CAP SCREW M5-0.8 X 20
99	X1667099	LABEL (MACHINE ID)
100	X1667100	LABEL (DEPTH CHART)
102	XPW05M	FLAT WASHER M4
103	XPS01M	PHLP HD SCREW M4-0.7 X 8

Drill Press Accessories

The following drill press accessories may be available through your local Woodstock International Inc. Dealer. If you do not have a dealer in your area, these products are also available through online dealers. Please call or e-mail Woodstock International Inc. Customer Service to get a current listing of dealers at: 1-800 840-8420 or at sales@woodstockint.com.

Sanding Sleeves are sized to fit the D2677 Drum Sander Set. These hard Sanding Sleeves are available in 60, 80, 100, 120, and 150 grits. Keep plenty of these consumable Sanding Sleeves on hand.

Sanding Sleeves					
Size (Dia. x Ht.)	60 Grit	80 Grit	100 Grit	120 Grit	150 Grit
1" X 4 1/4"	D2683	D2684	D2685	D2686	D2687
1 1/2" X 4 1/4"	D2688	D2689	D2690	D2691	D2692
2" X 4 1/4"	D2693	D2694	D2695	D2696	D2697



The **4" PRO-STIK® Stick with Handle** is the easiest solution for increasing the life of sanding sleeves by removing pitch and sawdust particles from the abrasive pores, which later harden in place if not removed. Simply press the cleaner lightly against the moving abrasive surface to remove clogged-up pitch and sawdust. PRO-STIK® cleaners are available in other sizes for any cleaning application that would need cleaners with handles, as blocks, or as flat pads. (Not recommended for wide-belt sanders.)



D2677 Drum Sander Set includes three rubber sanding drums 4 1/4" in length to accommodate 1", 1 1/2" and 2" diameter sanding sleeves. This kit also includes one 80 grit sleeve for each drum to get things started.



D2722 Mandrel is a 3/8" shank and is required to use our Drum Sander Set with any machine. Mandrel is included with the **SHOP FOX® Oscillating Drill Presses** featured above.

Drill Press Clamps adjust quickly and easily to lock your workpiece in any position. The clamping pad pivots to conform to any workpiece, ensuring uniform pressure.

- W1301 6" Drill Press Clamp (1 1/2" Capacity)
- D2192 10" Drill Press Clamp (3" Capacity)
- D2493 12" Drill Press Clamp (5" Capacity)

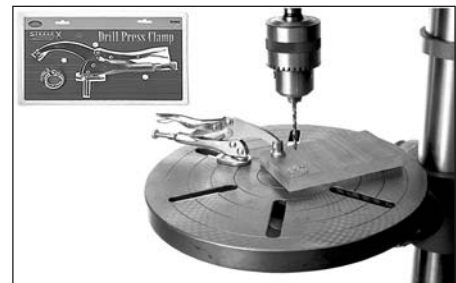

SHOP FOX® Drill Press Vises use precision ground steel guide rods, smooth-action Acme threads, ground steel jaws, with fixed jaw V-grooves for holding round stock, and dovetailed ways where applicable.

- D2727 SHOP FOX® (3" Basic Vise)
- D2728 SHOP FOX® (4" Basic Vise)
- D2729 SHOP FOX® (6" Basic Vise)
- D2933 SHOP FOX® (3 3/4" Angle Vise)
- D2730 SHOP FOX® (3" Cross Sliding Vise)
- D2731 SHOP FOX® (4" Cross Sliding Vise)

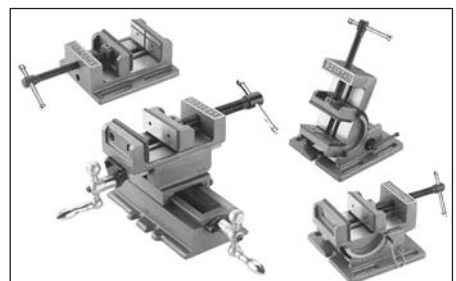

Drill Press Accessories

The SHOP FOX® D2056 Tool Table is great for bench-top tools like chop saws, drill presses, planers, scroll saws and bandsaws. Support cross braces on top provide incredible strength and capacity. Flared legs and adjustable rubber feet ensure stability and reduce machine vibration. Butcher block finish table top measures 13" x 23" and is 30½" tall with a 700 lb. capacity.



D2251 Steelex® Adjustable Circle Cutter cuts flat-sided holes in wood from 1" to 5". Made of M-2 alloy steel, this Circle Cutter features a 3/8" hex shank, 5/16" drill, center point and Allen® wrench.



D3161 Steelex® Heavy-Duty Carbide-Tipped Adjustable Circle Cutter is Carbide Tipped and cuts 1¾" to 5¾" diameter holes in the toughest material. For use with ½" drill press chucks. Includes hex wrench and 7/16" pilot drill.

Woodstock offers a full line of Brad Point Bits, Tenon/Plug Cutters, Countersink Bits, and Stubby Drill Bits to satisfy every need. Whether for do-it-yourselfers or professional woodworkers, you can depend on Woodstock International Inc. to manufacture a useful selection of drilling and cutting tools. Refer to <http://www.woodstockint.com/drilling.cfm> for a complete product line available through your dealer.

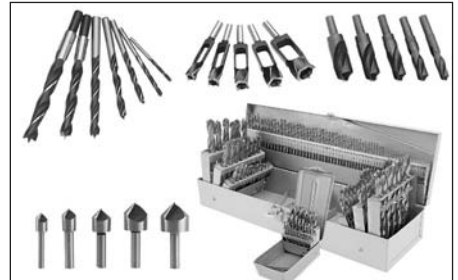

Steelex® Carded Forstner Bits stack up as some of the best bits in the world. In fact, an independent testing lab proved that the Steelex® brand cut was equal to or better than Forstner Bits from Austria, known for being the best. For use with drill presses. Refer to <http://www.woodstockint.com/forstner.cfm> for a complete product line available through your dealer.



Steelex Plus® Bi-Metal Hole Saws stay sharper longer than carbon steel hole saws. Equipped with high-speed steel alloy cutting teeth bonded to a welded steel body, they cut wood, metal and plastics with ease.

- D2784 10-pc. Bi-Metal Hole Saw Set
- D2020 8-pc. Aggressive Hole Saw Set
- D2783 6-pc. Bi-Metal Hole Saw Set
- D2797 ½" X 20 UNF Hole Saw Arbor
- D2798 5/8" X 18 UNF Hole Saw Arbor
- D2799 12" Hole-Saw Arbor Extension
- D2928 Replacement Pilot Drill for D2797
- D2929 Replacement Pilot Drill for D2798



WARRANTY CARD

Name _____
Street _____
City _____ State _____ Zip _____
Phone Number _____ E-Mail _____ FAX _____
MODEL _____ SERIAL # _____

The following information is given on a voluntary basis and is strictly confidential.

1. Where did you purchase your **SHOP FOX®** machine?
Store? _____ City? _____
2. How did you first learn about us?
___ Advertisement _____ Friend
___ Mail order Catalog _____ Local Store
___ World Wide Web Site
___ Other _____
3. Which of the following magazines do you subscribe to.
___ American Woodworker _____ Today's Homeowner
___ Cabinetmaker _____ WOOD
___ Family Handyman _____ Wooden Boat
___ Fine Homebuilding _____ Woodshop News
___ Fine Woodworking _____ Woodsmith
___ Home Handyman _____ Woodwork
___ Journal of Light Construction _____ Woodworker
___ Old House Journal _____ Woodworker's Journal
___ Popular Mechanics _____ Workbench
___ Popular Science _____ American How-To
___ Popular Woodworking
___ Other _____
4. Which of the following woodworking/remodeling shows do you watch?
___ Backyard America _____ The New Yankee Workshop
___ Home Time _____ This Old House
___ The American Woodworker _____ Woodwright's Shop
___ Other _____
5. What is your annual household income?
___ \$20,000-\$29,999 _____ \$60,000-\$69,999
___ \$30,000-\$39,999 _____ \$70,000-\$79,999
___ \$40,000-\$49,999 _____ \$80,000-\$89,999
___ \$50,000-\$59,999 _____ \$90,000 +
6. What is your age group?
___ 20-29 _____ 50-59
___ 30-39 _____ 60-69
___ 40-49 _____ 70 +
7. How long have you been a woodworker?
___ 0 - 2 Years _____ 8 - 20 Years
___ 2 - 8 Years _____ 20+ Years
8. How would you rank your woodworking skills?
___ Simple _____ Advanced
___ Intermediate _____ Master Craftsman
9. How many **SHOP FOX®** machines do you own? _____
10. What stationary woodworking tools do you own? Check all that apply.
___ Air Compressor _____ Panel Saw
___ Band Saw _____ Planer
___ Drill Press _____ Power Feeder
___ Drum Sander _____ Radial Arm Saw
___ Dust Collector _____ Shaper
___ Horizontal Boring Machine _____ Spindle Sander
___ Jointer _____ Table Saw
___ Lathe _____ Vacuum Veneer Press
___ Mortiser _____ Wide Belt Sander
___ Other _____
11. Which benchtop tools do you own? Check all that apply.
___ 1" x 42" Belt Sander _____ 6" - 8" Grinder
___ 5" - 8" Drill Press _____ Mini Lathe
___ 8" Table Saw _____ 10" - 12" Thickness Planer
___ 8" - 10" Bandsaw _____ Scroll Saw
___ Disc/Belt Sander _____ Spindle/Belt Sander
___ Mini Jointer
___ Other _____
12. Which portable/hand held power tools do you own? Check all that apply.
___ Belt Sander _____ Orbital Sander
___ Biscuit Joiner _____ Palm Sander
___ Circular Saw _____ Portable Planer
___ Detail Sander _____ Saber Saw
___ Drill/Driver _____ Reciprocating Saw
___ Miter Saw _____ Router
___ Other _____
13. What machines/supplies would you like to see?
___ 12" Table Saw _____ Radial Arm Saw
___ 12" Jointer _____ Panel Saw
___ Combination Planer/Jointer _____ Brass Hardware
___ Paint & Finish Supplies _____ Lumber
___ Contractor's Supplies
___ other _____
14. What new accessories would you like Woodstock International to carry?

15. Do you think your purchase represents good value?
___ Yes _____ No
16. Would you recommend **SHOP FOX®** products to a friend?
___ Yes _____ No
17. Comments: _____

CUT ALONG DOTTED LINE

FOLD ALONG DOTTED LINE

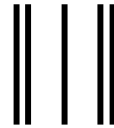
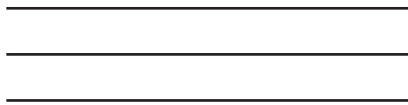

Place
Stamp
Here



WOODSTOCK INTERNATIONAL, INC.
P.O. BOX 2309
BELLINGHAM, WA 98227-2309



FOLD ALONG DOTTED LINE

TAPE ALONG EDGES--PLEASE DO NOT STAPLE

