

COSORI

User Manual

Premium 5.8-Quart Air Fryer

Model: CP158-AF



Questions or Concerns?

support@cosori.com | (888) 402-1684

Mon-Fri, 9:00 am-5:00 pm PST/PDT



(We hope you love your new air fryer as much as we do.)



join

the Cosori Cooks Community on Facebook
[facebook.com/groups/cosoricooks](https://www.facebook.com/groups/cosoricooks)



explore

our recipe gallery
www.cosori.com/recipes



enjoy

weekly, featured recipes
made exclusively by our in-house chefs



CONTACT OUR CHEFS

Our helpful, in-house chefs are ready to assist you with any questions you might have!

Email: recipes@cosori.com

Toll-Free: (888) 402-1684

M-F, 9:00 am–5:00 pm PST/PDT

On behalf of all of us at Cosori,

Happy cooking!

Table of Contents

Package Contents	3
Specifications	3
Important Safeguards	4
• Key Safety Points	4
• General Safety	5
• While Air Frying	5
• Plug and Cord	5
Getting to Know Your Air Fryer	6
Display Diagram	7
Display Messages	8
Before First Use	9
Using Your Air Fryer	11
• Preheating	11
• Air Frying	12
• Shaking Food	15
• Cooking Guide	16
• More Functions	17
Accessories	17
Care and Maintenance	18
Troubleshooting	19
Warranty Information	22
Customer Support	23

Specifications

Power Supply	AC 120V, 60Hz
Rated Power	1700W
Capacity	5.8 qt / 5.5 L (serves 3-5 people)
Temperature Range	170°–400°F / 77°–205°C
Time Range	1–60 min
Dimensions	10 x 10 x 12 in / 25.4 x 25.4 x 30.5 cm
Weight	11.5 lb / 5.2 kg

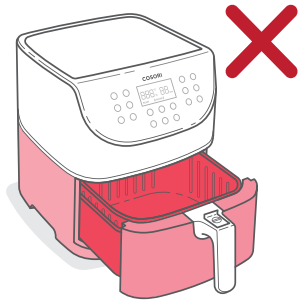
Package Contents

- 1 x Premium 5.8-Quart Air Fryer
- 1 x Recipe Book
- 1 x Reference Guide
- 1 x User Manual
- 1 x Warranty Card

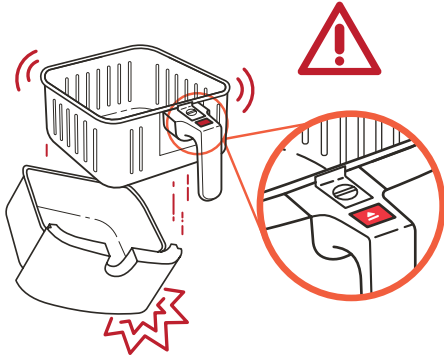
IMPORTANT SAFEGUARDS

Follow basic safety precautions when using your air fryer.
Read all instructions.

Key Safety Points

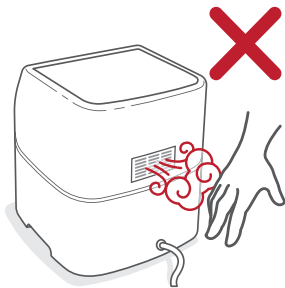


Do not touch hot surfaces.
Use handle.



Only press the basket release button with the baskets resting flat on any level, heat-resistant surface.

The handle is attached to the inner basket, not the outer basket. When you press the basket release button, the outer basket will **drop**.



Do not block any ventilation openings. Hot steam is released through openings. Keep your hands and face clear of openings.

General Safety

- **Do not** immerse the air fryer housing or plug in water or liquid.
- Closely supervise children near your air fryer.
- Unplug when not in use, and before cleaning. Allow to cool before putting on or taking off parts.
- **Do not** use your air fryer if it is damaged, not working, or if the cord or plug is damaged. Contact **Customer Support** (see page 23).
- **Do not** use third-party replacement parts or accessories, as this may cause injuries.
- **Do not** use outdoors.
- **Do not** place the air fryer or any of its parts on a stove, near gas or electric burners, or in a heated oven.
- Be extremely cautious when moving your air fryer (or removing the baskets) if it contains hot oil or other hot liquids.
- **Do not** clean with metal scouring pads. Metal fragments can break off the pad and touch electrical parts, creating a risk of electric shock.
- **Do not** place anything on top of your air fryer. **Do not** store anything inside your air fryer.
- **Only** use your air fryer as directed in this manual.
- Not for commercial use. Household use **only**.

While Air Frying

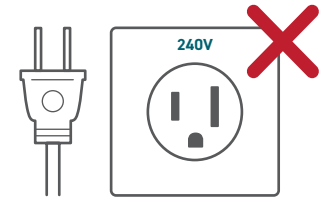
- An air fryer works with hot air only. **Never** fill the baskets with oil or fat.
- **Never** use your air fryer without the baskets in place.
- **Do not** place oversized foods or metal utensils into your air fryer.
- **Do not** place paper, cardboard, non-heat-resistant plastic, or similar materials into your air fryer. You may use parchment paper or foil.
- **Never** put baking or parchment paper into the air fryer without food on top. Air circulation can cause paper to lift and touch heating coils.
- **Always** use heat-safe containers. Be extremely cautious if using containers that aren't metal or glass.
- Keep your air fryer away from flammable

materials (curtains, tablecloth, etc). Use on a flat, stable, heat-resistant surface away from heat sources or liquids.

- Immediately turn off and unplug your air fryer if you see dark smoke coming out. Food is burning. Wait for smoke to clear before pulling the baskets out.
- **Do not** leave your air fryer unattended while in use.

Plug and Cord

- Your fryer has a polarized plug (one prong is wider than the other), which fits into a polarized outlet only one way. If the plug does not fit, reverse the plug. If it still does not fit, **do not** use the plug in that outlet. **Do not** alter the plug in any way.
- **Do not** let the power cord (or any extension cord) hang over the edge of a table or counter, or touch hot surfaces.
- Your air fryer should **only** be used with **120V, 60Hz** electrical systems. **Do not** plug into another type of outlet.



Note: This fryer uses a short power-supply cord to reduce the risk of entangling or tripping. Use extension cords with care. The marked electrical rating of the extension cord must be as great as the rating of the fryer (see page 3).

Electromagnetic Fields (EMF)

The Cosori Air Fryer complies with all standards regarding electromagnetic fields (EMF). If handled properly and according to the instructions in this user manual, the appliance is safe to use based on scientific evidence available today.

SAVE THESE INSTRUCTIONS

GETTING TO KNOW YOUR AIR FRYER

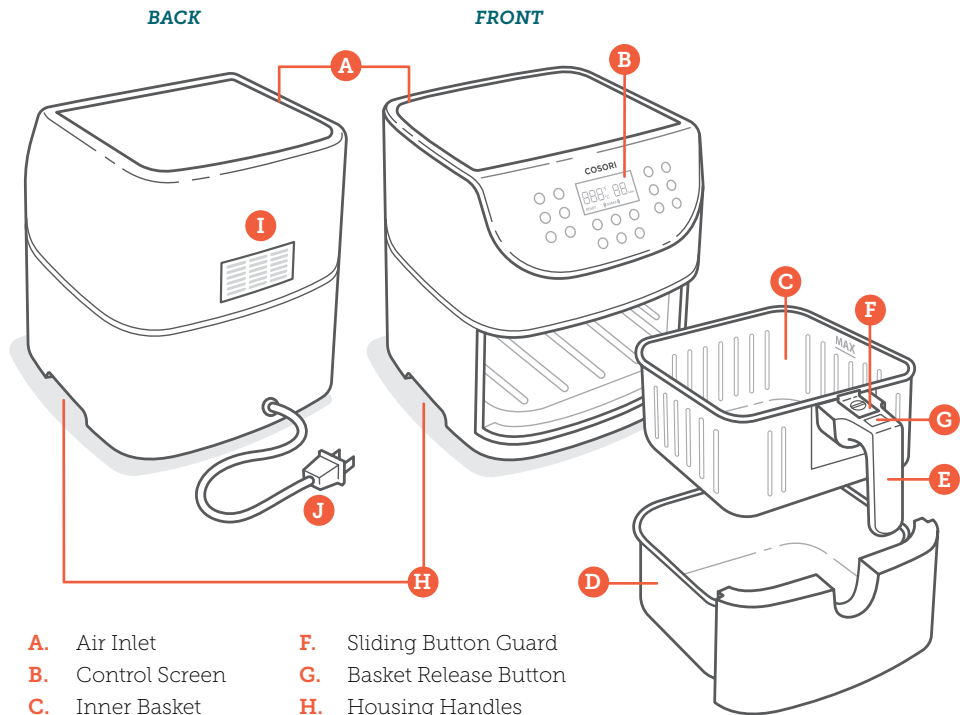
Your Cosori Air Fryer uses rapid 360° air circulation technology to cook with little-to-no oil, for quick, crispy, delicious food with up to 85% fewer calories than deep fryers. With user-friendly, one-touch controls, nonstick baskets, and an intuitive, safe design, the Cosori Air Fryer is the star of your kitchen.

Air Fryer Diagram



Note:

- **Do not** try to open the top of the air fryer. It is not a lid.
- The baskets are made of aluminum metal with nonstick coating. They are PFOA-free and BPA-free.



- A. Air Inlet
- B. Control Screen
- C. Inner Basket
- D. Outer Basket
- E. Basket Handle
- F. Sliding Button Guard
- G. Basket Release Button
- H. Housing Handles
- I. Air Outlet
- J. Power Cord

DISPLAY DIAGRAM

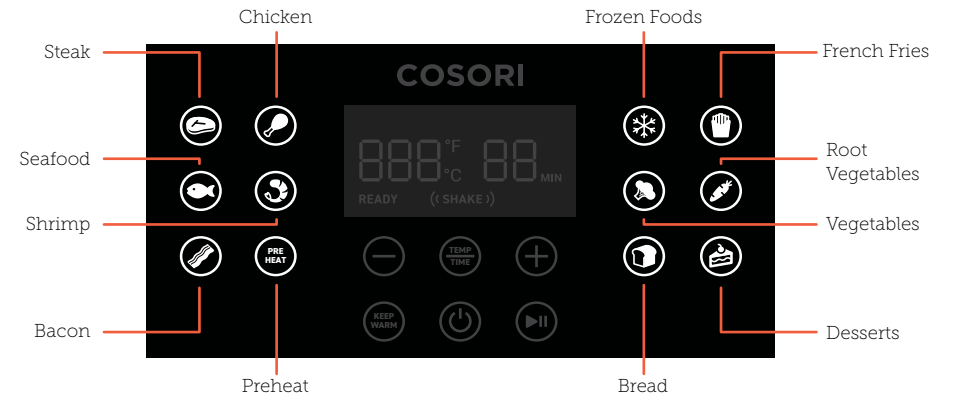
Note:

- When you press a button to use a function or program, it will turn blue to show that it's active. [Figure 1.1]

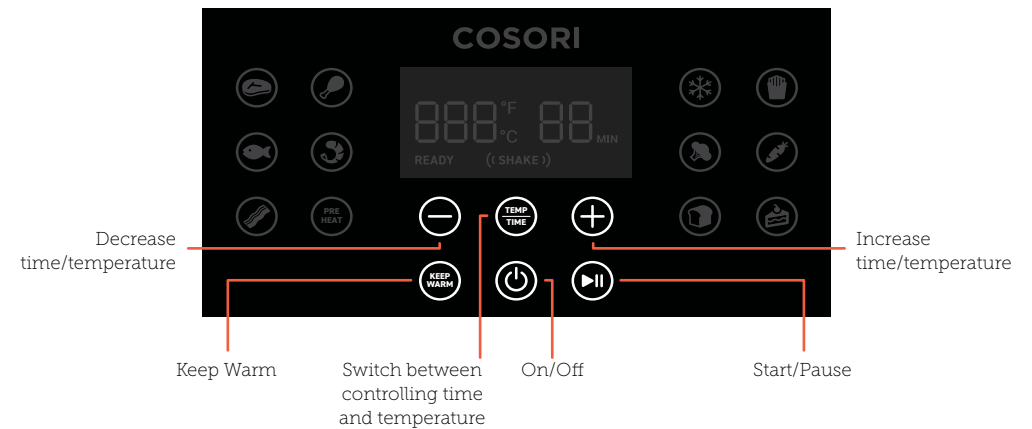


Figure 1.1

Presets

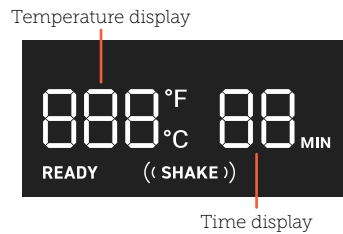


Control Panel

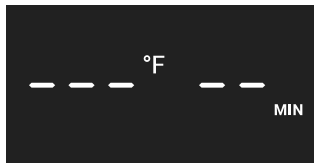


DISPLAY DIAGRAM (CONT.)

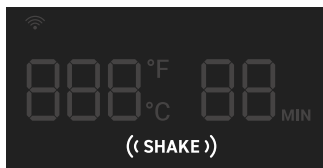
Display



DISPLAY MESSAGES



Cooking program has ended.



Reminder to shake or flip food.



Air fryer is preheated and ready to start cooking.

BEFORE FIRST USE

Setting Up

1. Remove all packaging from the air fryer, including any temporary stickers.
2. Place the air fryer on a stable, level, heat-resistant surface. Keep away from areas that can be damaged by steam (such as walls or cupboards).

Note: Leave 5 in / 13 cm of space behind and above the air fryer. [Figure 2.1] Leave enough room to remove the baskets.

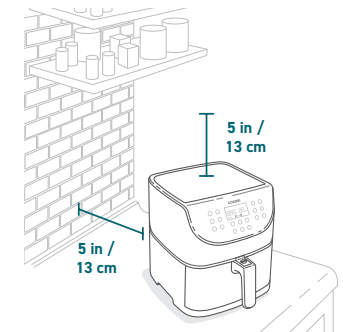


Figure 2.1

3. Pull the handle to remove the baskets. Remove all plastic from the baskets.
4. Press the basket release button to separate the inner basket from the outer basket. [Figure 2.2]
5. Wash both baskets thoroughly, using either a dishwasher or a non-abrasive sponge.
6. Wipe the inside and outside of the air fryer with a slightly moist cloth. Dry with a towel.
7. Put the baskets back inside the air fryer.

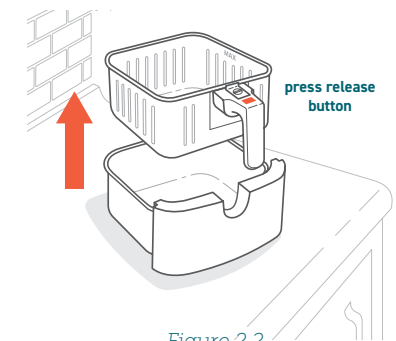


Figure 2.2

Test Run

A test run will help you become familiar with your air fryer, make sure it's working correctly, and clean it of possible residues in the process.

1. Make sure the air fryer baskets are empty and plug in the air fryer.
2. Press **Preheat**. The display will show "400°F" and "5 MIN".
3. Press **▶||** to begin preheating. When preheating is done, the air fryer will beep.
4. Pull out the baskets and let them cool for 5 minutes. Then place the empty baskets back in the air fryer.
5. Press **🍖** to select the Steak preset. The display will show "400°F" and "6 MIN".
6. Press **Temp/Time** twice. The time will blink on the display. Press the **-** button once to change the time to 5 minutes.
7. Press **▶||** to begin. When finished, the air fryer will beep.
8. Pull out the baskets. This time, let the baskets cool completely for 10–30 minutes.

Basket Tips

- Separate baskets **only** after cooking, to serve food and wash baskets.
- The button guard protects the release button from being pressed accidentally. Slide the button guard forward to press the release button. [Figure 2.3]
- **Never** press the release button while carrying the baskets.
- **Only** press the release button with the baskets resting flat on a counter (or any level, heat-resistant surface).
- The handle is attached to the inner basket, not the outer basket. [Figure 2.2] When you press the release button, the outer basket will **drop**.

Note:

- **Do not** unscrew the basket handle from the baskets.
- To order accessories, please contact **Customer Support** (see page 23).

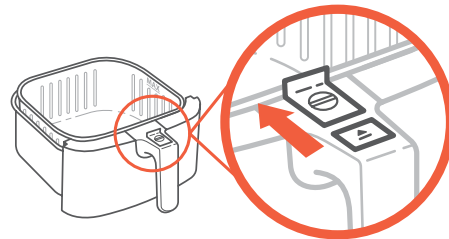


Figure 2.3

USING YOUR AIR FRYER

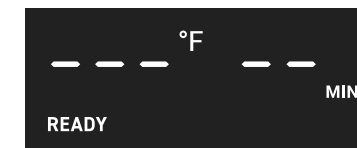
Preheating

We recommend preheating before placing food inside the air fryer, unless your air fryer is already hot. Food will not cook thoroughly without preheating.

1. Plug in. Press **⏻** to turn on the air fryer.
2. Press **Preheat**. The display will show "400°F" and "5 MIN".
3. Optionally, press the **+** or **-** buttons to change the temperature. The time will adjust automatically.

Temperature	Time
400°F / 205°C	5 minutes
390°F / 199°C	5 minutes
380°F / 193°C	5 minutes
370°F / 188°C	4 minutes
360°F / 182°C	4 minutes
350°F / 177°C	4 minutes
340°F / 171°C	4 minutes
330°F / 166°C and below	3 minutes

4. Press **▶||** to begin preheating.
5. When preheating is done, the air fryer will beep 3 times. The display will show:



Note: If no buttons are pressed for 3 minutes, the air fryer will clear all settings and go into standby.

Air Frying

Note:

- **Do not** place anything on top of your air fryer. This disrupts airflow and causes poor air frying results. [Figure 3.1]
- An air fryer is not a deep fryer. **Do not** fill the baskets with oil, frying fat, or any liquid.
- When taking the baskets out of the air fryer, be careful of hot steam, and **do not** press the basket release button.

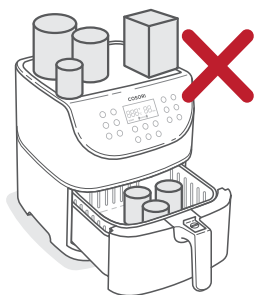


Figure 3.1

Preset Settings

- You can customize time (1–60 minutes) and temperature (170°–400°F / 77°–205°C), unless noted.
- Results may vary. Check out our Reference Guide and Recipe Book for a guide to customizing presets for perfect results.

Preset	Symbol	Default Temperature	Default Time (Minutes)	Shake Reminder?*
Steak		400°F / 205°C	6 minutes	-
Chicken		380°F / 193°C	25 minutes	-
Seafood		350°F / 177°C	8 minutes	-
Shrimp		370°F / 188°C	6 minutes	((SHAKE))
Bacon		320°F / 160°C	8 minutes	-
Frozen Foods		350°F / 177°C	10 minutes	((SHAKE))
French Fries**		380°F / 193°C	25 minutes	((SHAKE))
Vegetables		300°F / 149°C	10 minutes	((SHAKE))
Root Vegetables		400°F / 205°C	12 minutes	((SHAKE))
Bread		320°F / 160°C	8 minutes	-
Desserts		300°F / 149°C	30 minutes	-
Preheat		400°F / 205°C	5 minutes	-
Keep Warm		170°F / 77°C	5 minutes	-

* See **Shaking Food** (page 15).

** See **Cooking Guide** (page 16) for more tips on air frying french fries.

Preset Air Frying Programs

Using a preset is the easiest way to air fry. Presets are programmed with an ideal time and temperature for cooking certain foods.

1. **Preheat your air fryer** (see page 11).
2. When your air fryer displays “READY”, add food to the baskets.
3. Select a preset cooking program (see page 12).
4. Optionally, customize the temperature and time. You can do this anytime during cooking.

- c. Put the baskets back into the air fryer.

Note: See **Shaking Food** (page 15).

7. The air fryer will beep 3 times when finished. The display will show:



- a. Press **Temp/Time** once. The temperature will blink on the display. Press the **+** or **-** buttons to change the temperature (170°F–400°F / 77°C–205°C).
- b. Press **Temp/Time** a second time. The time will blink on the display. Press the **+** or **-** buttons to change the time (1–60 minutes).

Note: To rapidly increase or decrease time or temperature, press and hold the **+** or **-** buttons.

5. Press **▶||** to begin air frying.
6. When using certain presets, the Shake Reminder will appear halfway through cooking time. The air fryer will beep 5 times, and “((SHAKE))” will blink on the display.

- a. Take the baskets out of the air fryer, being careful of hot steam. The air fryer will pause cooking automatically. The display will turn off until the baskets are replaced.

- b. Shake or flip the food. Be careful not to press the basket release button.

8. Optionally, press **Keep Warm**. Press the **+** or **-** buttons to change the time (1–60 minutes).
9. Take the baskets out of the air fryer, being careful of hot steam.
10. Remove inner basket from the outer basket to serve food. When separating baskets:
 - a. Make sure the baskets are resting on a flat surface.
 - b. Watch for hot oil or fat collected in the outer basket. To avoid splashing, drain oil before replacing inner basket. [Figure 4.1]
11. Allow to cool before cleaning.

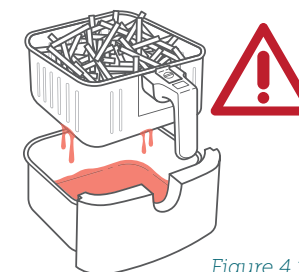


Figure 4.1

Manual Air Frying

1. **Preheat your air fryer** (see page 11).
2. When your air fryer displays “**READY**”, add food to the baskets.
3. Set the temperature and time. You can change this any time during cooking.
 - a. Press **Temp/Time** once. The temperature will blink on the display. Press the **+** or **-** buttons to change the temperature (170°–400°F / 77°–205°C).
 - b. Press **Temp/Time** a second time. The time will blink on the display. Press the **+** or **-** buttons to change the time (1–60 minutes).

Note: To rapidly increase or decrease time or temperature, press and hold the **+** or **-** buttons.

4. Press **▶||** to begin air frying.

Note:

- When manually air frying, there will be no Shake Reminder. You should still shake or flip appropriate foods.
- If you want the Shake Reminder, select a preset program with the reminder (see page 12) and change the time and temperature as desired.

5. The air fryer will beep 3 times when finished. The display will show:



6. Optionally, press **Keep Warm**. Press the **+** or **-** buttons to change the time (1–60 minutes).
7. Take the baskets out of the air fryer, being careful of hot steam.
8. Remove the inner basket from the outer basket to serve food. When separating baskets:
 - a. Make sure the baskets are resting on a flat surface.
 - b. Watch for hot oil or fat collected in the outer basket. To avoid splashing, drain oil before replacing inner basket. [Figure 4.1]
9. Allow to cool before cleaning.

Shaking Food

How to Shake

- During cooking, take the baskets out of the air fryer and shake, mix, or flip the food.
 - A. To shake food:
 1. Hold the basket just above a heat-resistant surface for safety purposes. **Do not** press the basket release button.
 2. Shake the baskets.
 - B. If the baskets are too heavy to shake:
 1. Place the baskets on a heat-resistant holder or surface.
 2. Separate the baskets. Make sure no liquids are dripping from the inner basket.
 3. Carefully shake the inner basket.
- **Note:** **Do not** use this method if there is a risk of hot liquids splashing.
- C. If the baskets are too heavy to shake and there are hot liquids present:
 1. Place the baskets on a heat-resistant holder or surface.
 2. Use tongs to mix or flip the food.

- When you take the baskets out, the air fryer will pause cooking automatically. As a safety feature, the display will turn off until the baskets are replaced.
- When you replace the baskets, cooking will automatically resume.
- Avoid shaking longer than 30 seconds, as the air fryer may start to cool down.

What to Shake

- Small foods that are stacked will usually need shaking, such as fries or nuggets.
- Without shaking, foods may not be crispy or evenly cooked.
- You can flip other foods, such as steak, to ensure even browning.

When to Shake

- Shake or flip food once halfway through cooking, or more if desired.
- Certain presets use the Shake Reminder (see **Preset Settings**, page 12).

Shake Reminder

- The Shake Reminder will alert you with 5 beeps, and “**((SHAKE))**” will blink on the display.
- If you do not remove the baskets, the Shake Reminder will beep again after 1 minute and the display will show a solid “**((SHAKE))**”.
- The Shake Reminder will go away once you take out the baskets.

Cooking Guide

Overfilling

- If the basket is overfilled, food will cook unevenly.
- Food should not be filled over the "MAX" line of the inner basket. [Figure 5.1] **Do not** pack in food.



Figure 5.1

Using Oil

- Adding a small amount of oil to your food will make it crispier. Use no more than 2 US tbsp / 30 mL of oil.
- Oil sprays are excellent for applying small amounts of oil evenly to all food items.

Food Tips

- You can air fry any frozen foods or goods that can be baked in an oven.
- To make cakes, hand pies, or any food with filling or batter, place food in a heat-safe container before placing in the baskets.
- Air frying high-fat foods will cause fat to drip to the bottom of the baskets. To avoid excess smoke while cooking, pour out fat drippings after cooking.
- Liquid-marinated foods create splatter and excess smoke. Pat these foods dry before air frying.

French Fries

- Add ½–1 US tbsp / 15 mL oil for crispiness.
- When making fries from raw potatoes, soak uncooked fries in water for 15 minutes to remove starch prior to frying. Pat dry with a towel before adding oil.
- Cut uncooked fries smaller for crispier results. Try cutting fries into ¼- by 3-in / 0.6- by 7.6-cm strips.

Note: For more from the Cosori Kitchen, check out our *Recipe Book and Tips from the Chef*.

More Functions

Switching Temperature Units

- Press and hold **Temp/Time** for 3 seconds.
 - The air fryer will beep once, and the temperature unit will change from Fahrenheit to Celsius.
 - Repeat to switch back to Fahrenheit.

Pausing

- Press ►|| to pause cooking. The air fryer will stop heating, and ►|| will blink until you press ►|| to resume cooking.
 - After 30 minutes of inactivity, the air fryer will turn off.
 - This function allows you to pause the cooking program without removing the baskets from the air fryer.

Automatically Resume Cooking

- If you pull out the baskets, the air fryer will pause cooking automatically. The display will turn off temporarily as a safety feature.
- When you return the baskets, the air fryer will automatically resume cooking based on your previous settings.

Automatic Shutoff

- If the air fryer has no active cooking programs, the air fryer will clear all settings and turn off after 3 minutes of inactivity.

Overheat Protection

- If the air fryer overheats, it will automatically shut down as a safety feature.
- Let the air fryer cool down completely before using it again.

ACCESSORIES

You can purchase accessories for your air fryer from **cosori.com** by scanning the QR code.



CARE AND MAINTENANCE

Note:

- **Always** clean the air fryer baskets and interior after every use.
- Lining the outer basket with foil may make cleanup easier.

1. Turn off and unplug the air fryer. Allow it to cool completely before cleaning. Pull out the baskets for faster cooling.
2. Wipe the outside of the air fryer with a moist cloth, if necessary.
3. The baskets are dishwasher safe. You can also wash the baskets with hot, soapy water and a non-abrasive sponge. Soak if necessary.

Note: Baskets have a nonstick coating. Avoid metal utensils and abrasive cleaning materials.

4. For stubborn grease:
 - a. In a small bowl, mix 2 US tbsp / 30 mL of baking soda and 1 US tbsp / 15 mL of water to form a spreadable paste.
 - b. Use a sponge to spread the paste on the baskets and scrub. Let the baskets sit for 15 minutes before rinsing.
 - c. Wash baskets with soap and water before using.

5. Clean the inside of the air fryer with a slightly moist, non-abrasive sponge or cloth. **Do not** immerse in water. [Figure 6.1] If needed, clean the heating coil to remove food debris.

6. Dry before using.

Note: Make sure that the heating coil is completely dry before turning on the air fryer.

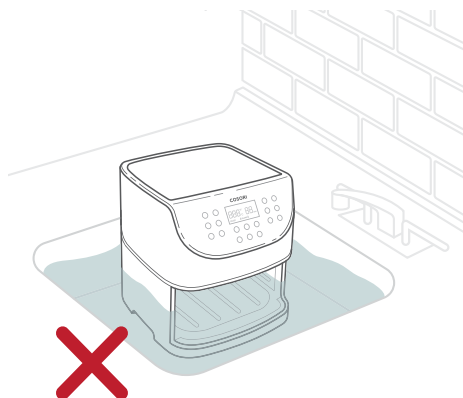


Figure 6.1

TROUBLESHOOTING

Problem	Possible Solution
The air fryer will not turn on.	Make sure the air fryer is plugged in.
	Push the baskets securely into the air fryer.
Foods are not completely cooked.	Place smaller batches of ingredients into the inner basket. If the basket is overstuffed, then ingredients will be undercooked.
	Increase cooking temperature or time.
Foods are cooked unevenly.	Ingredients that are stacked on top of each other or close to each other need to be shaken or flipped during cooking (see Shaking Food , page 15).
Foods are not crispy after air frying.	Spraying or brushing a small amount of oil on foods can increase crispiness (see Cooking Guide , page 16).
French fries are not cooked correctly.	See French Fries , page 16.
Baskets will not slide into the air fryer securely.	Make sure the basket is not overfilled with food.
	Make sure the inner basket is securely inside the outer basket.
White smoke is coming out of the air fryer.	The air fryer may produce some white smoke when you use it for the first time. This is normal.
	Make sure the baskets and the inside of the air fryer are cleaned properly and not greasy.
	Cooking greasy foods will cause oil to leak into the outer basket. This oil will produce white smoke, and the baskets may be hotter than usual. This is normal, and should not affect cooking. Handle baskets with care.
Dark smoke is coming out of the air fryer.	Immediately unplug your air fryer. Food is burning. Wait for smoke to clear before pulling the baskets out.
The air fryer has a plastic smell.	Any air fryer may have a plastic smell from the manufacturing process. This is normal. Follow the instructions for a Test Run (page 10) to get rid of the plastic smell. If a plastic smell is still present, please contact Customer Support (see page 23).

TROUBLESHOOTING (CONT.)

Problem	Possible Solution
Display shows Error Code "E1".	There is an open circuit in the temperature monitor. Contact Customer Support (see page 23).
Display shows Error Code "E2".	There is a short circuit in the temperature monitor. Contact Customer Support (see page 23).

If your problem is not listed, please contact **Customer Support** (see page 22).

FCC STATEMENT

This device complies with Part 15 of the FCC Rules. Operation is subject to the following two conditions:

- (1) This device may not cause harmful interference, and
- (2) This device must accept any interference received, including interference that may cause undesired operation.

Any changes or modifications not expressly approved by the party responsible for compliance could void the user's authority to operate this equipment.

This equipment has been tested and found to comply with the limits for a Class B digital device, pursuant to Part 15 of the FCC Rules. These limits are designed to provide reasonable protection against harmful interference in a residential installation. This equipment generates, uses and can radiate radio frequency energy and, if not installed and used in accordance with the instructions, may cause harmful interference to radio communications. However, there is no guarantee that interference will not occur in a particular installation. If this equipment does cause harmful interference to radio or television reception, which can be determined by turning the equipment off and on, the user is encouraged to try to correct the interference by one of the following measures:

- Reorient or relocate the receiving antenna.
- Connect the equipment into an outlet on a circuit different from that to which the receiver is connected.
- Increase the separation between the equipment and receiver.
- Consult the dealer or an experienced radio/TV technician for help.

FCC Radiation Exposure Statement

This equipment complies with FCC radiation exposure limits set forth for an uncontrolled environment. End users must follow the specific operating instructions for satisfying RF exposure compliance. To maintain compliance with FCC RF exposure compliance requirements, please follow operation instructions as documented in this manual. This transmitter must not be co-located or operating in conjunction with any other antenna or transmitter. This equipment should be installed and operated with a minimum distance of 20 cm between the radiator and your body. The availability of some specific channels and/or operational frequency bands are country dependent and are firmware programmed at the factory to match the intended destination. The firmware setting is not accessible by the end user.

WARRANTY INFORMATION

Product Name	Premium 5.8-Quart Air Fryer
Model	CP158-AF
Default Warranty Period	1 year
<i>For your own reference, we strongly recommend that you record your order ID and date of purchase.</i>	
Date of Purchase	
Order ID	

TERMS & POLICY

Arovast Corporation warrants all products to be of the highest quality in material, craftsmanship, and service, effective starting from the date of purchase to the end of the warranty period.

Arovast Corporation will replace any product found to be defective due to manufacturer flaws based on eligibility. Refunds are available within the first 30 days of purchase. Refunds are only available to the original purchaser of the product. This warranty extends only to personal use and does not extend to any product that has been used for commercial, rental, or any other use in which the product is not intended for. There are no warranties other than the warranties expressly set forth with each product.

This warranty is non-transferrable. Arovast Corporation is not responsible in any way for any damages, losses, or inconveniences caused by equipment failure or by user negligence, abuse, or use noncompliant with the user manual or any additional safety or usage warnings included in the product packaging and manual.

This warranty does not apply to the following:

- Damage due to abuse, accident, alteration, misuse, tampering, or vandalism.
- Improper or inadequate maintenance.
- Damage in return transit.
- Unsupervised use by children under 18 years of age.

Arovast Corporation and its subsidiaries assume no liability for damage caused by the use of the product other than for its intended use or as instructed in the user manual. Some states do not allow this exclusion or limitation of incidental or consequential losses, so the foregoing disclaimer may not apply to you. This warranty gives you specific legal rights and you may also have other rights, which may vary from state to state.

ALL EXPRESSED AND IMPLIED WARRANTIES, INCLUDING THE WARRANTY OF MERCHANTABILITY, ARE LIMITED TO THE PERIOD OF THE LIMITED WARRANTY.

Additional 1-Year Warranty

You can extend your 1-year warranty by an additional year. Log onto www.cosori.com/warranty to register your new product for the extended warranty.

Please fill out all required fields and include your order ID, place of purchase, and purchase date, if applicable.

Defective Products & Returns

Should your product prove defective within the specified warranty period, please contact Customer Support via support@cosori.com with your order ID. **Do not** dispose of your product before contacting us. Once our Customer Support Team has approved your request, please return the unit with a copy of your invoice and order ID.

CUSTOMER SUPPORT

We're Here to Help

If you encounter any issues or have any questions about your new product, please contact our helpful Customer Support Team. Your satisfaction is our goal!

Customer Support

Arovast Corporation
1202 N. Miller St., Suite A
Anaheim, CA 92806

Email: support@cosori.com

Toll-Free: (888) 402-1684

Support Hours

Mon–Fri, 9:00 am–5:00 pm PST/PDT

* Please have your order confirmation ID ready before contacting Customer Support.

SHOW US WHAT YOU'RE MAKING

We hope this manual has been helpful. We can't wait to see your beautiful results, and we think you'll want to share glam shots! Our community awaits your uploads—just pick your platform of choice below. Snap, tag, and hashtag away, Cosori chef!

#iCookCosori



@cosoricooks



Cosori Appliances

Considering what to cook? Many recipe ideas are available, both from us and the Cosori community.

MORE COSORI PRODUCTS

If you're happy with this air fryer, the line doesn't stop here. Check out www.cosori.com for a line of all our beautiful and thoughtfully designed cookware. They might be right at home in your kitchen, too!

NOTES

NOTES

COSORI

Questions or Concerns?

Mon–Fri, 9:00 am–5:00 pm PST/PDT
support@cosori.com | (888) 402-1684

AU0120GY-M1_0120CP158-AF