

A few simple steps to ensure
perfect water, every time.





Use and Care Guide

MODELS: A10-TL

Registration

Please visit the website below to register your new water cooler within the first 30 days of purchase. Registration within the first 30 days will activate your one year warranty.

www.avalonh2o.com/register-my-avalon-cooler

Please keep your model number, order number and purchase date for future support. You can reach us at 1-800-256-0695.

Model Number _____

Order Number _____

Purchase Date _____



Conforms to NSF/ANSI 372

Contents

About Your Water Cooler

Meet Your Avalon Product	1
Part Names	2-3
Indicator Lights	4
Tech Specs	5

Getting Started

Unpacking	7
Operation Instructions	9-10

Cleaning

Rinsing, Cleaning and Draining	12-14
Cleaning	15-16

Troubleshooting	18-19
-----------------	-------

Safety	21-22
--------	-------

Meet Your Avalon Product



Attractive Design

Attractive stainless steel design with 3 water spouts



Custom Temperature

Piping hot, room temperature or crisp cold water



Top Loading

Suitable for 3 or 5 gallon bottles



UL Listed

We design & manufacture with your safety in mind



Energy Star Approved

Saves the environment & your wallet



Child Safety Feature

Ensures safe hot water flow for the entire family

Part Names

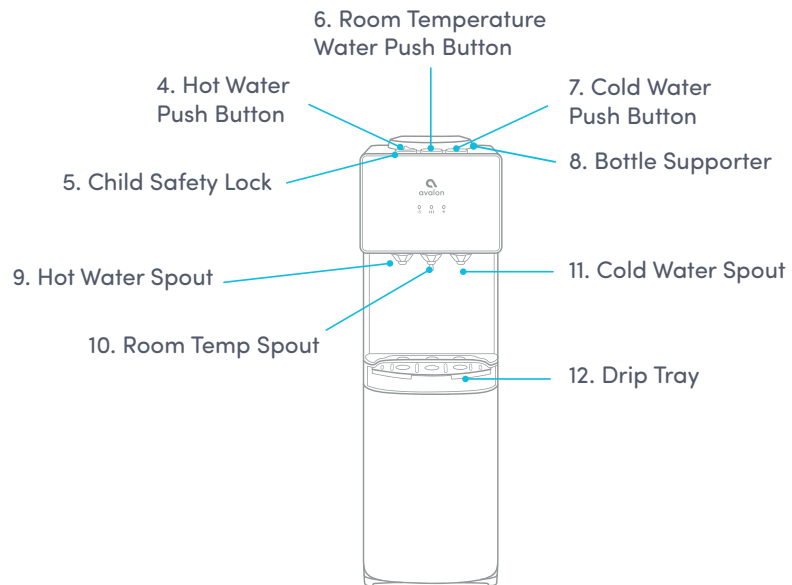
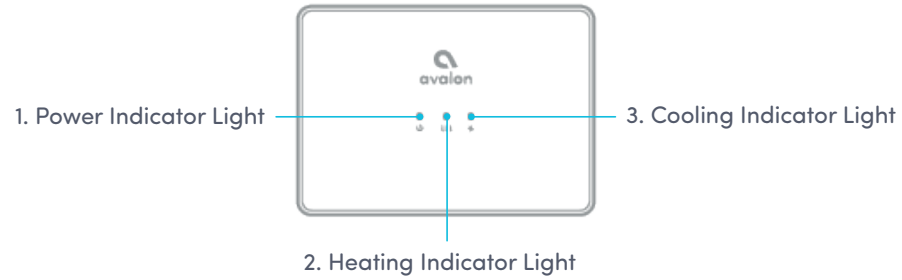

Part Names

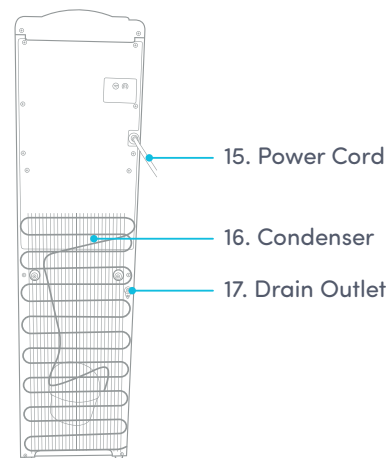
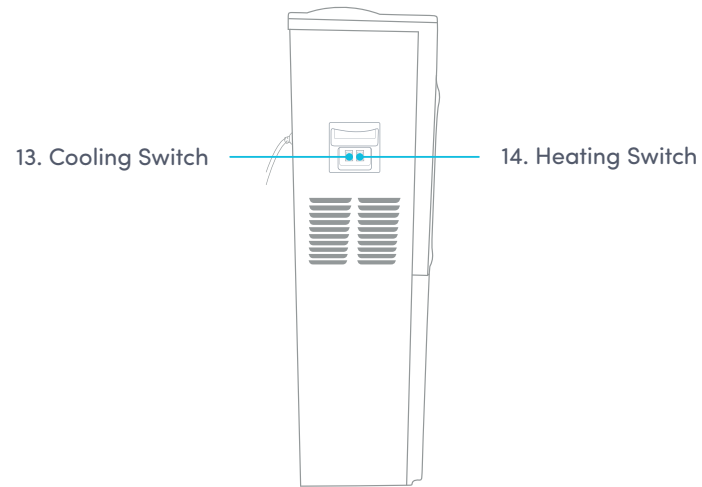

Indicator Lights

Power Indicator Light



This light will remain on as long as the water cooler is plugged in to indicate that the cooler is on.

Heating Indicator Light



This light will indicate when the water is heating. The light will remain on while the water is heating and will turn off when it has reached the correct temperature of 185°F. As the water is dispensed the hot tank will refill and the water will heat. As the water reheats this indicator light will turn on.

Cooling Indicator Light



This light will indicate when the water is cooling. The light will remain on while the water is cooling and will turn off when it has reach the correct temperature of 47°F. As the water is dispensed the cold tank will refill and the water will cool. As the water cools this indicator light will turn on.

Tech Specs

Model	A10-TL
Hot/Cold/Room Temp Output	1.2L/min / 1.2L/min /1.0L/min
Hot Water Capacity	4 L/H (≥ 185°F)
Hot Tank Volume	1.02 Liters
Cold Water Capacity	2 L/H (≤ 47°F)
Cold Tank Volume	3 Liters
Product Size	13"(L)x12"(W)x40"(H)
Packing Size	16"(L)x15"(W)x42.5"(H)
Net Weight/Gross Weight	34.17 lb /38.58 lb
Voltage/Frequency	115 V 60Hz
Cooling Method	Compressor
Heating Method	Internal Element
Heating Watts / Cooling Watts	420W / 100 W
Power Consumption	520 W

Getting Started

Unpacking Your Avalon Water Cooler

The unit has been cleaned prior to departing from the factory. To remove any dust and debris that may collect during shipping we recommend cleaning the unit prior to installation. For cleaning instructions see pages 12-16.

Locating Dispenser

Do NOT plug in the power cord yet.

Place dispenser upright on a hard and level surface in a cool and shaded location near a grounded wall outlet. Position the dispenser so there is about four inches of clearance from the wall on the back and both sides.

Operation Instructions

Do not plug in the machine or turn on the heating (#14) and cooling (#13) switches until water has begun to dispense from the cold (#5) and hot (#8) water spout.

1. Remove any label or sticker from the mouth of the bottle.

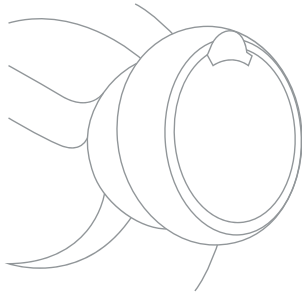

2. Vertically insert the bottle into the bottle supporter (#1) on the top of the machine. The bottle supporter has a built-in puncturing rod to allow you to use spill proof caps without opening the plastic bottle seals.



Operation Instructions

3. Depress the hot (#4) cold (#7) and the room temperature (#6) water push button to dispense water from each spout. To dispense the hot water, slide the red child safety lock (#5) to the left and depress the hot water push button (#4) downward to begin the flow of water. You must slide the child safety lock (#5) and push the button simultaneously.

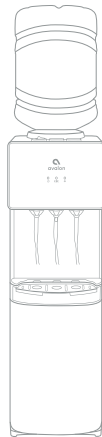

4. Once water is dispensing from both spouts insert the power plug into a power socket. Turn on (I) the heating switch (#14) and the cooling switch (#13). (If you do not wish to have hot water please leave the heating switch (#14) in the off (O) position. If you do not wish to have cold water please leave the cooling switch (#13) in the off (O) position.

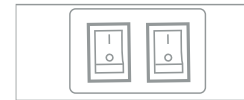

Operation Instructions

5. Once the switches are in the on (I) position the heating indicator light (#2) and the cooling indicator light (#3) will turn on. It will take about 15 – 20 minutes for the hot water to heat to the appropriate temperature. It will take about 1 hour for the cold water to cool to the appropriate temperature.



6. When the water has reached the appropriate temperatures for hot and cold the indicator lights will turn off and the water is ready for use. The indicator lights will turn back on automatically when the machine needs to reheat or cool again.



7. To replace the bottle vertically, pull out the empty bottle with two hands. Using two hands place the new bottle of water vertically into the bottle supporter (#8).



Cleaning

Rinsing, Cleaning, and Draining

To prolong the lifetime of the machine, it is recommended that the unit be cleaned and sanitized manually about every six months.

To clean the outside of the unit

Use a disinfectant of your choice to wipe down the outside of the machine. Disinfectant does not come with this unit. It can be purchased separately from a local store.

To rinse the inside of the unit

The machine has been disinfected prior to departing from the factory. However, it is recommended to rinse and drain the unit prior to installation.

1. Before cleaning, make sure that the cooling switch (#13) and heating switch (#14) are in the off (O) position and unplug the machine.



2. Once the machine is off, pour water into the top of the unit where the bottle would be placed.

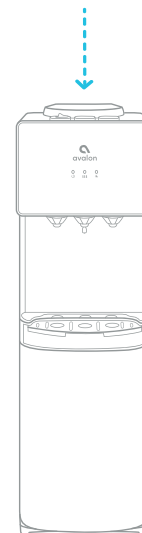

Rinsing, Cleaning, and Draining

3. Dispense about 2 liters of water from the unit into a bucket by pressing dispense buttons for each temperature.

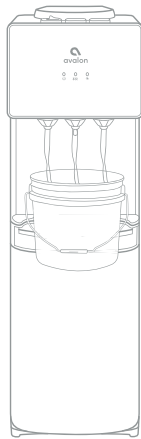

4. Place a large bucket beneath the drain outlet (#17) located on the back of the unit. Remove the drain cover and plug and allow the water to drain from the unit. Water will start flowing as soon as the drain cover is removed.

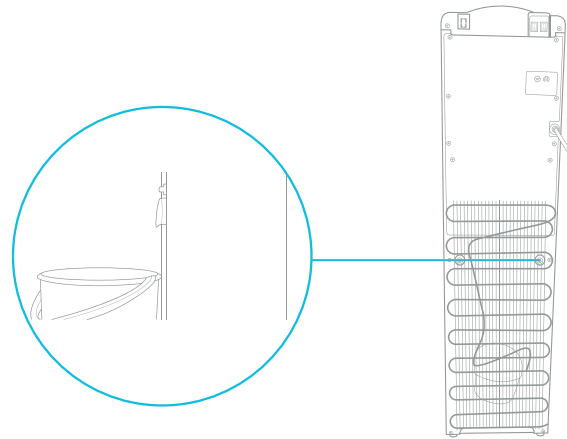

Caution: The dispenser will heat water to a temperature of approximately 185°F. It can cause severe burns if not handled carefully. Please use caution while operating and cleaning.

Rinsing, Cleaning, and Draining

5. Remove any remaining water in the tanks by dispensing water from the hot (#5) and cold (#9) water spouts into a bucket.



6. After draining is complete, replace the drain cover and plug and use the machine as normal.

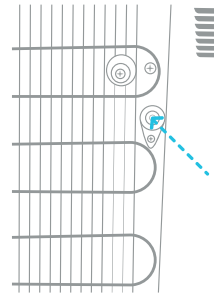

Cleaning

To remove mineral deposits that may have built up inside the the cold tank, mix 4 L of water with 200 g of citric acid crystals (not included) or a cleaning solution of your choice.

1. Twist or lift off the bottle supporter (#8).

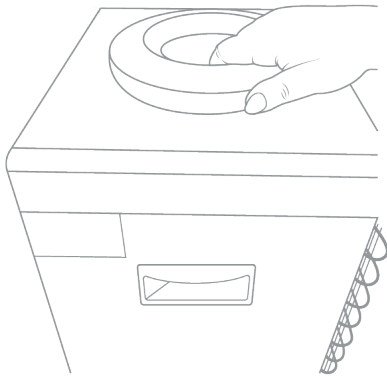

2. Put the mixture into the machine's cold tank and make sure the water can flow out of the hot water spout (#9).

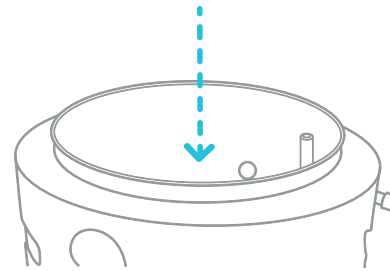

Cleaning

3. Plug in the power cord and turn on (I) the heating switch (#14). Allow the water to heat for 15 minutes.



4. Turn off (O) the heating switch (#14) and allow the liquid mixture to cool down for 20 minutes.

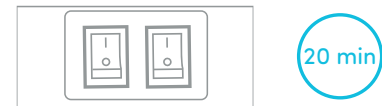

5. Drain the liquid from the drain outlet (#17), then flush with water two or three times by following the rinsing instructions above. Only disassemble parts mentioned to avoid damaging the machine.

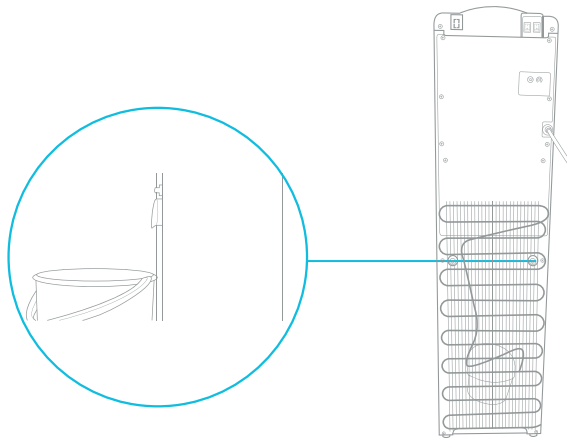

Troubleshooting

Troubleshooting

If you are having trouble with your water cooler please see the following solutions. You can also view our trouble shooting videos at the website below. Please feel free to contact us with any questions.



1-800-256-0695



support@avalonh2o.com



www.avalonh2o.com

Troubleshooting

Water not dispensing at a hot or cold temperature

This could be caused by an over consumption of water in a short period of time causing the tanks to empty. Please allow 5 to 10 minutes for the water cooler tanks to refill. Allow the proper time for the water to heat and cool.

This could be caused by an interruption in the power supply. Please ensure that the power cord is connected to an outlet. Please make sure that the heating (#14) and cooling (#13) switches are in the on (I) position.

No water dispensing from spouts

This could be caused by the water bottle being empty. Please replace the bottle and allow 5-10 minutes for the water cooler tanks to fill up. Allow the proper time for the water to heat and cool.

This could be the result of the bottle supporter (#8) being blocked. Please lift the bottle from the bottle supporter with two hands. Check to ensure that the seal or possible paper from the bottle is not causing a blockage. Install the bottle again.

Water is leaking from the bottle supporter (#8)

This could be the cause of a broken bottle. Please check to make sure that the bottle is not broken and if so please replace it.

This could also be caused by a misaligned seal. Using two hands please remove the bottle. Please remove the bottle supporter (#8) and ensure that the seal is aligned correctly around the edge.

Noisy operation

This could be caused by the machine not sitting flat. Please make sure that the machine is placed on a placid and solid surface.

Safety

Safety

To reduce risk of injury and property damage, user must read this entire guide before assembling, installing and operating the dispenser.

Failure to execute the instructions in this manual can cause personal injury or property damage.

This product dispenses water at very high temperatures. Failure to use this properly can cause personal injury.

When operating this dispenser, always exercise basic safety precautions, including the following:

- Prior to use, this dispenser must be properly assembled and installed in accordance with this manual.
- This dispenser is intended for water dispensing only. Do NOT use other liquids. Do NOT use for other purposes. Never use any other liquid in the dispenser other than known microbiologically safe tap water.
- For indoor use only. Keep water dispenser in a dry place away from direct sunlight. Do NOT use outdoors.
- Install and use only on a hard, flat and level surface.
- Do NOT place dispenser in an enclosed space or cabinet.
- Do NOT operate the dispenser in the presence of explosive fumes.
- Position back of dispenser no closer than 20 cm from wall and permit free airflow between wall and dispenser. There must be at least 20 cm clearance on the sides of the dispenser to permit airflow.
- Use only properly grounded outlets.
- Do not use an extension cord with your water dispenser.
- Always grasp plug and pull straight out from outlet. Never unplug by pulling on power cord.
- To protect against electric shock, do NOT immerse cord, plug or any other part of the dispenser in water or other liquid.

Safety

- Ensure dispenser is unplugged prior to cleaning.
- Never allow children to dispense hot water without proper and direct supervision. Unplug unit to prevent unsupervised use by children.
- Service should be performed only by a certified technician.
- Warning: Do not damage the refrigerant circuit.
- This appliance can be used by children aged from 8 years and above if they have been given supervision or instruction concerning use of the appliance in a safe way and if they understand the hazards involved. Cleaning and user maintenance shall not be made by children unless they are older than 8 and supervised. Keep the appliance and its cord out of reach of children less than 8 years.
- Appliances can be used by persons with reduced physical, sensory or mental capabilities or lack of experience and knowledge if they have been given supervision or instruction concerning use of the appliance in a safe way and understand the hazards involved. Children shall not play with the appliance.
- This appliance is intended to be used in a household and similar applications such as: kitchen area in shops, offices and other working environments, bed and breakfast type environments, catering and similar non-retail applications.
- Do not store explosive substances such as aerosol cans with flammable propellant in this appliance.
- If the supply cord is damaged, it must be replaced by a special cord assembly available from the manufacturer or its service agent.
- Never turn the machine upside down or lean it more than 45°.
- Thermostat has been adjusted. There is no need to adjust it by yourself. When the matching is below the freezing point and blocked by ice, the cooling switch should be turned off for 4 hours before turning it on again to continue its operation.
- This machine should not be plugged back in until 3 minutes after it has been unplugged.

