

Rain Gauge model 02446



CONTENTS

Unpacking Instructions	2	Rain Gauge Installation	8
Package Contents	2	Using the Rain Gauge	9
Product Registration	2	Programmable Rain Alarm.....	9
Features & Benefits: Rain Gauge ...	3	Troubleshooting	10
Features & Benefits: Display	4	Calibration	11
Setup	5	Care & Maintenance	12
Rain Gauge Setup.....	5	Specifications.....	12
Display Setup	6	FCC Information	12
Set Time, Date & Units.....	7	Customer Support	13
Placement Guidelines	7	Warranty.....	13

Questions? Contact Customer Support at www.AcuRite.com/support or email support@chaney-inst.com

SAVE THIS MANUAL FOR FUTURE REFERENCE.



Congratulations on your new AcuRite product. To ensure the best possible product performance, please read this manual in its entirety and retain it for future reference.

Unpacking Instructions

Remove the protective film that is applied to the LCD screen prior to using this product. Locate the tab and peel off to remove. Remove packing materials from inside of the rain gauge.

Package Contents

1. Display
2. Rain Gauge
3. Instruction Manual

IMPORTANT

PRODUCT MUST BE REGISTERED
TO RECEIVE WARRANTY SERVICE

PRODUCT REGISTRATION

Register online to receive 1 year warranty protection

www.AcuRite.com

Features & Benefits

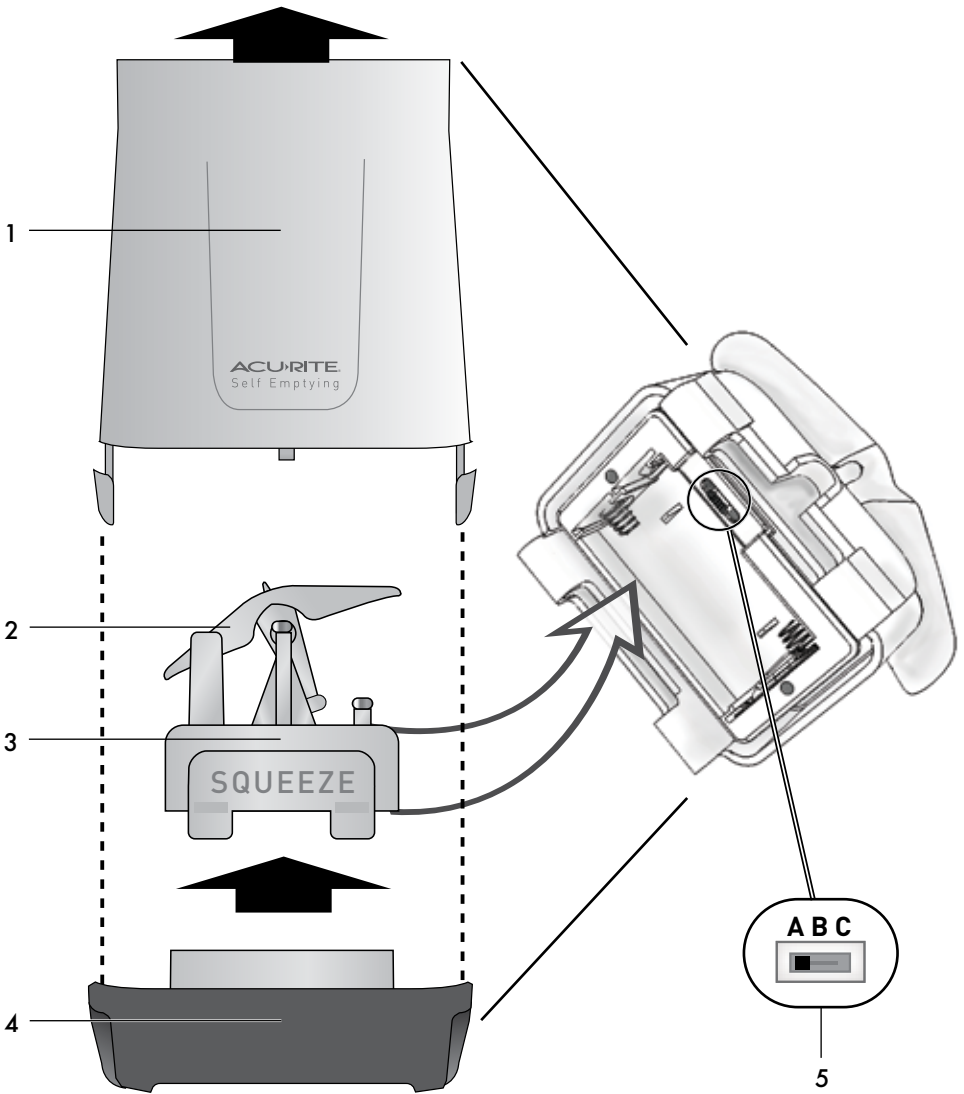

RAIN GAUGE

- 1. Rain Gauge Cover**
- 2. Rain Gauge Tipping Cups**
Collects and empties rain for continuous rain measurement.
- 3. Battery Compartment & Electronics Box**
- 4. Rain Gauge Base**
- 5. A-B-C Switch**
ID code that must match display's A-B-C switch to ensure units synchronize.

Features & Benefits

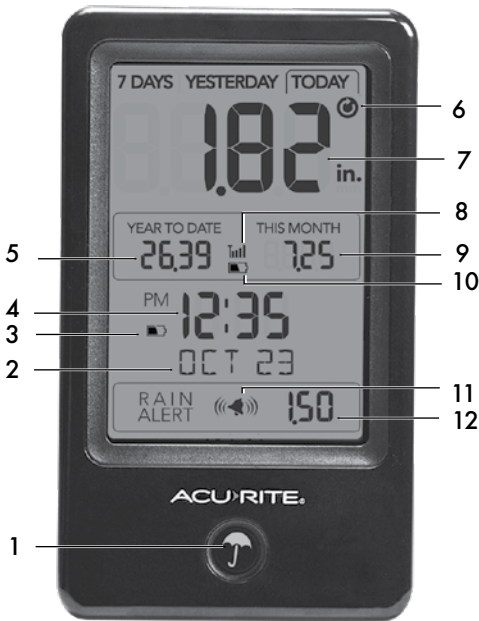

DISPLAY

1. Button

Press to manually toggle between rainfall readings for TODAY, YESTERDAY, 7 DAYS, or by MONTH. Press and hold to automatically toggle between readings for TODAY, YESTERDAY and 7 DAYS.

2. Date

3. Display Low Battery Indicator

4. Clock

5. Year-To-Date Rainfall Total

6. Icon

Indicates rainfall readings are in auto-cycle mode.

7. Rainfall Total

For time range indicated above.

8. Rain Gauge Signal Strength

9. Month-To-Date Rainfall Total

10. Rain Gauge Low Battery Indicator

11. Icon

Indicates a rain alert has been set.

12. Rain Alert Value

Alarm will sound if value is exceeded for today's rainfall.

13. Integrated Hang Hole

For easy wall mounting.

14. & Buttons

For setup preferences and to adjust rain alert value.

15. SET Button

For setup preferences.

16. Battery Compartment

17. A-B-C Switch

For setup preferences.

18. Battery Compartment Cover (not shown)

Rain Gauge Setup

Install or Replace Batteries

AcuRite recommends high quality alkaline batteries for the best product performance. Heavy duty or rechargeable batteries are not recommended.

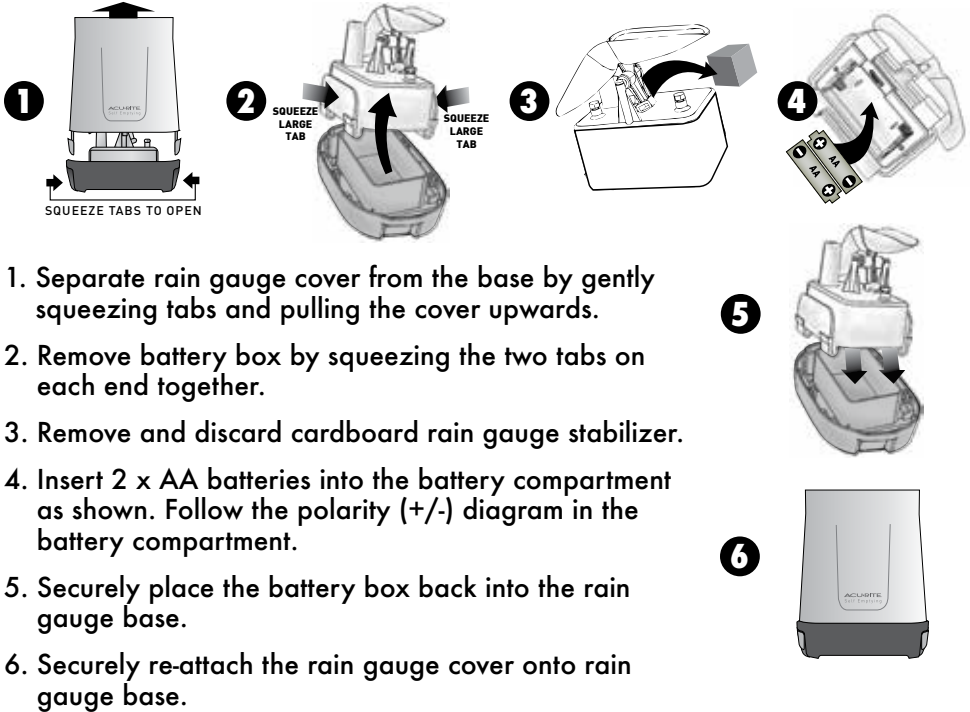
- 
1. Separate rain gauge cover from the base by gently squeezing tabs and pulling the cover upwards.
 2. Remove battery box by squeezing the two tabs on each end together.
 3. Remove and discard cardboard rain gauge stabilizer.
 4. Insert 2 x AA batteries into the battery compartment as shown. Follow the polarity (+/-) diagram in the battery compartment.
 5. Securely place the battery box back into the rain gauge base.
 6. Securely re-attach the rain gauge cover onto rain gauge base.

Set the A-B-C Switch

Locate the A-B-C switch inside the battery compartment. Set the A-B-C switch to A, B or C. You must select the same letter choices for both the rain gauge and the display in order for the units to synchronize.

A-B-C Switch
Set to match display

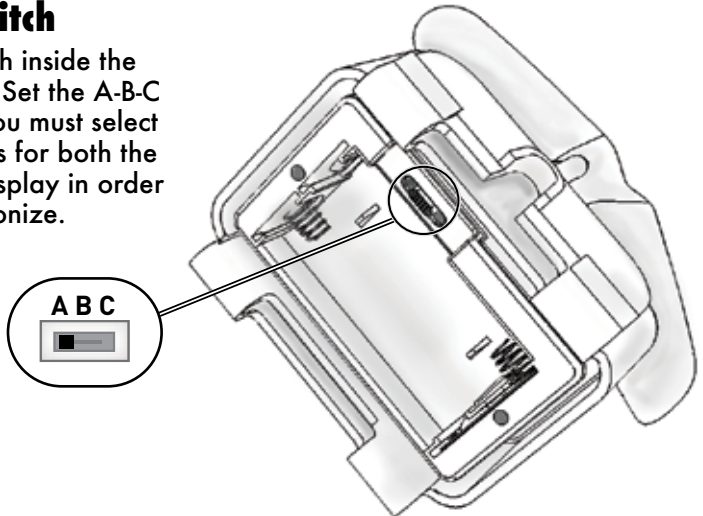

Display Setup

1 Set the A-B-C Switch

Locate the A-B-C switch inside the battery compartment. Set the A-B-C switch to A, B or C. You must select the same letter choices for both the display and the rain gauge in order for the units to synchronize.

2 Install or Replace Batteries

1. Remove the battery compartment cover.
2. Insert 3 x AAA alkaline batteries into the battery compartment, as shown. Follow the polarity (+/-) diagram in the battery compartment.
3. Replace the battery cover.

1 A-B-C Switch Set to match rain gauge

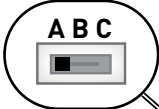

2 Install Batteries 3 AAA batteries

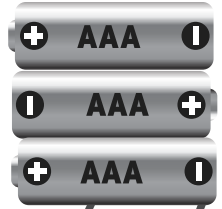

PLEASE DISPOSE OF OLD OR DEFECTIVE BATTERIES IN AN ENVIRONMENTALLY SAFE WAY AND IN ACCORDANCE WITH YOUR LOCAL LAWS AND REGULATIONS.

BATTERY SAFETY: Clean the battery contacts and also those of the device prior to battery installation. Remove batteries from equipment which is not to be used for an extended period of time. Follow the polarity (+/-) diagram in the battery compartment. Promptly remove dead batteries from the device. Dispose of used batteries properly. Only batteries of the same or equivalent type as recommended are to be used. DO NOT incinerate used batteries. DO NOT dispose of batteries in fire, as batteries may explode or leak. DO NOT mix old and new batteries or types of batteries (alkaline/standard). DO NOT use rechargeable batteries. DO NOT recharge non-rechargeable batteries. DO NOT short-circuit the supply terminals.

Set the Time, Date & Units

This rain gauge is equipped with historical data and alarms that require accurate time and date settings to function properly. It is important to set the time, date and units before using the rain gauge.

Press and release the "SET" button to enter SET MODE. Once in set mode, the preference you are currently setting will blink on the display.

To adjust the currently selected (flashing) item, press and release the "▲" or "▼" button (press and HOLD to fast adjust).

To save your adjustments, press and release the "SET" button again to adjust the next preference. The preference set order is as follows:

CLOCK HOUR (note AM/PM indicators)

CLOCK MINUTE

CALENDAR MONTH

CALENDAR DATE

CALENDAR YEAR

UNITS (INCH or MM)

You will automatically exit SET MODE if no buttons are pressed for 8 seconds. Enter SET MODE at any time by pressing the "SET" button.

Placement for Maximum Accuracy

AcuRite sensors are sensitive to surrounding environmental conditions. Proper placement of both the display and rain gauge are critical to the accuracy and performance of this product.

Display Placement



Place the display in a dry area free of dirt and dust.

Display stands upright for tabletop use or is wall-mountable.

Important Placement Guidelines

- Display and rain gauge must be within 100 ft (30 m) of each other.
- To maximize wireless range and communication, install the rain gauge at least 3 ft (.9 m) above ground. Place both the display and the rain gauge away from large metallic items, thick walls, metal surfaces, or other objects that may limit wireless communication.
- To prevent wireless interference, place both units at least 3 ft (0.9 m) away from electronic devices (TV, computer, microwave, radio, etc.)

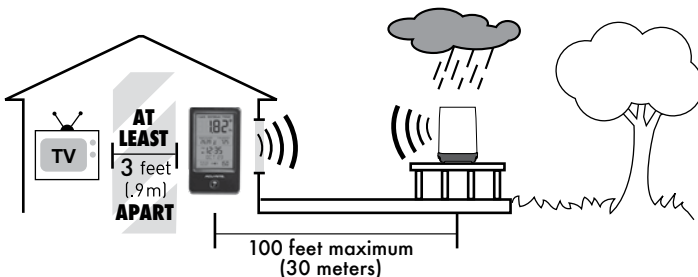

Rain Gauge Installation

- To ensure accurate rain measurement, the rain gauge **MUST** be placed on a flat, level surface.
- Ensure the rain gauge is not placed in a low spot that could become flooded or in an area where there are obstructions above it.

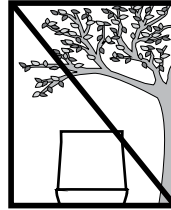
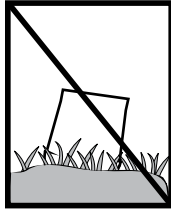
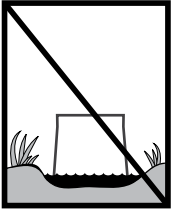

1. Separate the rain gauge cover from the rain gauge base.
2. Locate the two holes on the rain gauge base.
3. Fasten the rain gauge base to a sturdy surface, like a deck railing or a fence post, with screws (included) using hand tools. (Power tools may slip during installation, causing damage to the rain gauge.)

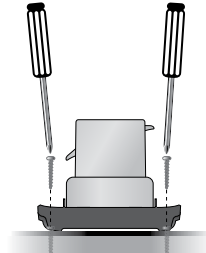
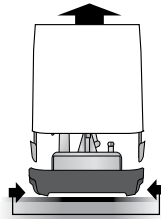

Setup is Complete

The rain gauge will now synchronize with the display. It may take a few minutes for synchronization to complete. Please refer to the troubleshooting section of this manual if anything appears to be functioning improperly.

Using the Rain Gauge

Rainfall Records

Press and release the  button on the front of the display to cycle through historical rainfall records. Records order as follows:

TODAY (resets at midnight)

YESTERDAY

7 DAYS

MONTH (up to previous 13 months)

YEAR

After 3 seconds of inactivity, the display will exit records mode. View records at any time by pressing the  button.

Rain Alarm

By default, the display's rain alert is set to OFF. To set the alarm value, use the  and  buttons on the back of the display to select the parameter for rainfall. Choose from a selection of rain accumulation thresholds.

When a rain alert has been activated, an audible alarm will sound and the display will flash the rainfall value. Press any button to silence the alarm.

Disable the alarm at any time by pressing the  button until the alert value shows "OFF".

Troubleshooting

<p>No rainfall: Display shows dashes</p>	<p>Dashes indicate that the display and rain gauge are not synchronized.</p> <ul style="list-style-type: none">• Relocate the display and/or the rain gauge. The units must be within 100 ft (30 m) of each other.• Make sure both units are placed at least 3 feet (0.9 m) away from electronics that may interfere with the wireless communication (such as TVs, microwaves, computers, etc).• Use standard alkaline batteries. Do not use heavy duty or rechargeable batteries. NOTE: It may take a few minutes for display and rain gauge to synchronize after batteries are replaced.• Try resetting the units:<ol style="list-style-type: none">1. Bring both the display and rain gauge indoors and position side by side.2. Remove the batteries from both units.3. Reinstall batteries in the rain gauge first.4. Reinstall batteries in the display last.5. Let the units sit within a couple feet of each other for a few minutes to gain a strong connection.
<p>No rainfall: Display shows zeroes</p>	<p>Remove rain gauge cover. Does the tipping lever flip back and forth easily? Try tipping it manually to see if it will register this as rain. If not try the reset steps listed above.</p>
<p>Rainfall registering when there's no rain</p>	<ul style="list-style-type: none">• Make sure the rain gauge is mounted securely so that it cannot move or sway in the wind. The rain gauge should be mounted on a solid and level surface in a clear area away from any overhead obstructions that may block rainfall.• Make sure you are using standard alkaline batteries (not heavy duty, max or rechargeable).
<p>Can the rain gauge remain outdoors in freezing temperatures?</p>	<p>No, the rainfall gauge should be brought indoors when there is a possibility of freezing temperatures. Water expands when it freezes. If any water is left within the collector during a freeze, it can crack the plastic and cause permanent damage.</p>
<p>Display screen not working</p>	<ul style="list-style-type: none">• Check that the batteries are installed correctly. Batteries may need to be replaced.

If your AcuRite product does not operate properly after trying the troubleshooting steps, visit www.AcuRite.com or email support@chaney-inst.com for assistance.

Calibration

Calibrate the Rain Gauge

The rain gauge can be calibrated to improve accuracy.

Items Needed: rain gauge, display, plastic cup, pin, screw driver

1. First, place the rain gauge on a level surface.
2. Place the display close by so you can monitor it during calibration.
3. Make a pin hole in the bottom of a plastic cup. Hold the cup over the rain gauge and fill it with exactly 1 cup (8 oz.) of water, allowing the water to slowly drip into the rain gauge. You should hear the internal cups tipping and see the water drain through the rain gauge.
4. A few seconds after each cup tip, the display will display rainfall in approximately 0.01" (0.2 mm) or more increments.
5. The cup of water should take more than 20 minutes to empty; a quicker period will result in an inaccurate calibration. Try to simulate a normal steady rainfall. When the cup is empty of water, the display should register 1.68" (42.67 mm).

Tips

- There should be nearly an equal number of water drops between cup tips. If not, then adjust the calibration screws beneath the tipping lever until an equal number of water drops are tipping the cups. Then, restart the calibration procedure.
- If you don't hear the cups tipping and see water dripping alternately out of each drain, there may be an issue with the rain gauge or it's adjustment.

Adjustment

If the rain gauge doesn't register close to 1.68" (42.67 mm) after the cup is empty, make an EQUAL adjustment to the two calibration screws, located beneath the tipping cups. Turn screws counter-clockwise to increase rainfall; turn screw clockwise to decrease rainfall.

- To adjust the rainfall reading by 2% turn both screws 1/4 of a turn.
- To adjust the rainfall reading by 4% turn both screws 1/2 of a turn.
- To adjust the rainfall reading by 8% turn both screws 1 full turn.

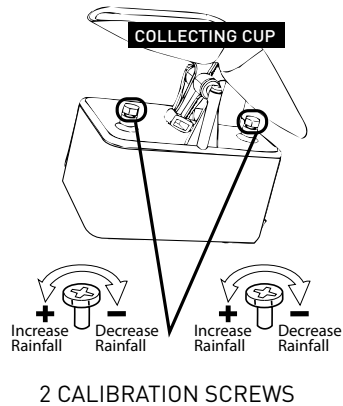

Care & Maintenance

Display Care

Clean with a soft, damp cloth. Do not use caustic cleaners or abrasives. Keep away from dust, dirt and moisture. Clean ventilation ports regularly with a gentle puff of air.

Rain Gauge Care

Clean with a soft damp cloth. Do not use caustic cleaners or abrasives that could mar the polished surface of the rain collector or tipping cups. If the rain gauge becomes dirty, rain water may not flow correctly through the rain collector. Some environmental conditions may require more frequent, periodic cleaning of the rain gauge. After a cleaning, it is recommend to apply a small amount of liquid water repellent (found in the automotive section) to the tipping cups and collector funnel for optimal rain collection.

The rain gauge cannot be used in the winter during freezing temperatures. Water expands when it freezes. If any water is left within the unit during a freeze, it can crack the plastic and permanently damage the unit.

Specifications

RAINFALL RANGE	0.01 inches (0.25 mm) and up
WIRELESS RANGE	100 ft / 30 m depending on home construction materials
WIRELESS FREQUENCY	433 MHz
POWER	Display: 3 x AAA alkaline batteries
	Rain Gauge: 2 x AA alkaline batteries
DATA REPORTING	60 second updates

FCC Information

This device complies with part 15 of FCC rules. Operation is subject to the following two conditions:

- 1- This device may NOT cause harmful interference, and
- 2- This device must accept any interference received, including interference that may cause undesired operation.

WARNING: Changes or modifications to this unit not expressly approved by the party responsible for compliance could void the user's authority to operate the equipment.

NOTE: This equipment has been tested and found to comply with the limits for a Class B digital device, pursuant to Part 15 of the FCC rules. These limits are designed to provide reasonable protection against harmful interference in a residential installation. This equipment generates, uses and can radiate radio frequency energy and, if not installed and used in accordance with the instructions, may cause harmful interference to radio communications. However, there is no guarantee that interference will not occur in a particular installation. If this equipment does cause harmful interference to radio or television reception, which can be determined by turning the equipment off and on, the user is encouraged to try to correct the interference by one or more of the following measures:

- Reorient or relocate the receiving antenna.
- Increase the separation between the equipment and the receiver.
- Connect the equipment into an outlet on a circuit different from that to which the receiver is connected.
- Consult the dealer or an experienced radio/TV technician for help.

NOTE: The manufacturer is not responsible for any radio or TV interference caused by unauthorized modifications to this equipment. Such modifications could void the user authority to operate the equipment.

Customer Support

AcuRite customer support is committed to providing you with best-in-class service. For assistance, please have the model number of this product available and contact us in any of the following ways:



support@chaney-inst.com

Visit us at www.AcuRite.com

- ▶ Installation Videos
- ▶ Register your Product
- ▶ Instruction Manuals
- ▶ Submit Feedback & Ideas
- ▶ Replacement Parts

IMPORTANT

PRODUCT MUST BE REGISTERED
TO RECEIVE WARRANTY SERVICE

PRODUCT REGISTRATION

Register online to receive 1 year warranty protection

www.AcuRite.com

Limited 1-Year Warranty

AcuRite is a wholly owned subsidiary of Chaney Instrument Company. For purchases of AcuRite products, AcuRite provides the benefits and services set forth herein. For purchases of Chaney products, Chaney provides the benefits and services set forth herein.

We warrant that all products we manufacture under this warranty are of good material and workmanship and, when properly installed and operated, will be free of defects for a period of one year from the date of purchase.

Any product which, under normal use and service, is proven to breach the warranty contained herein within ONE YEAR from date of sale will, upon examination by us, and at our sole option, be repaired or replaced by us. Transportation costs and charges for returned goods shall be paid for by the purchaser. We hereby disclaim all responsibility for such transportation costs and charges. This warranty will not be breached, and we will give no credit for products which have received normal wear and tear not affecting the functionality of the product, been damaged (including by acts of nature), tampered, abused, improperly installed, or repaired or altered by others than our authorized representatives.

Remedy for breach of this warranty is limited to repair or replacement of the defective item(s). If we determine that repair or replacement is not feasible, we may, at our option, refund the amount of the original purchase price.

THE ABOVE-DESCRIBED WARRANTY IS THE SOLE WARRANTY FOR THE PRODUCTS AND IS EXPRESSLY IN LIEU OF ALL OTHER WARRANTIES, EXPRESS OR IMPLIED. ALL OTHER WARRANTIES OTHER THAN THE EXPRESS WARRANTY SET FORTH HEREIN ARE HEREBY EXPRESSLY DISCLAIMED, INCLUDING WITHOUT LIMITATION THE IMPLIED WARRANTY OF MERCHANTABILITY AND THE IMPLIED WARRANTY OF FITNESS FOR A PARTICULAR PURPOSE.

We expressly disclaim all liability for special, consequential, or incidental damages, whether arising in tort or by contract from any breach of this warranty. Some states do not allow the exclusion or limitation of incidental or consequential damages, so the above limitation or exclusion may not apply to you.

We further disclaim liability from personal injury relating to our products to the extent permitted by law. By acceptance of any of our products, the purchaser assumes all liability for the consequences arising from their use or misuse. No person, firm or corporation is authorized to bind us to any other obligation or liability in connection with the sale of our products. Furthermore, no person, firm or corporation is authorized to modify or waive the terms of this warranty unless done in writing and signed by a duly authorized agent of ours.

In no case shall our liability for any claim relating to our products, your purchase or your use thereof, exceed the original purchase price paid for the product.

Applicability of Policy

This Return, Refund, and Warranty Policy applies only to purchases made in the United States and Canada. For purchases made in a country other than the United States or Canada, please consult the policies applicable to the country in which you made your purchase.

Additionally, this Policy applies only to the original purchaser of our products. We cannot and do not offer any return, refund, or warranty services if you buy products used or from resale sites such as eBay or Craigslist.

Governing Law

This Return, Refund, and Warranty Policy is governed by the laws of the United States and the State of Wisconsin. Any dispute relating to this Policy shall be brought exclusively in the federal or State courts having jurisdiction in Walworth County, Wisconsin; and purchaser consents to jurisdiction within the State of Wisconsin.

ACU RITE®



Weather
Stations



Temperature
& Humidity



Weather
Alert Radio



Kitchen
Thermometers
& Timers



Clocks

It's more than accurate, it's ACU RITE.

AcuRite offers an extensive assortment of precision instruments, designed to provide you with information you can depend on to Plan your day with confidence™.

www.AcuRite.com