



Item #1003011838
Model #70233HTSP

Item #1003011839
Model #70234HTVP

Item #1003011851
Model #70231HTRE

Item #1003011862
Model #70232HTME

USE AND CARE GUIDE

36 IN. METAL TRACK STARTER PACK

36 IN. METAL TRACK VALUE PACK

48 IN. METAL TRACK

84 IN. METAL TRACK

Questions, problems, missing parts?
Before returning to the store, call
Husky Customer Service
8 a.m. - 7 p.m., EST, Monday - Friday
9 a.m. - 6 p.m., EST, Saturday

1-888-HD-HUSKY

HUSKYTOOLS.COM

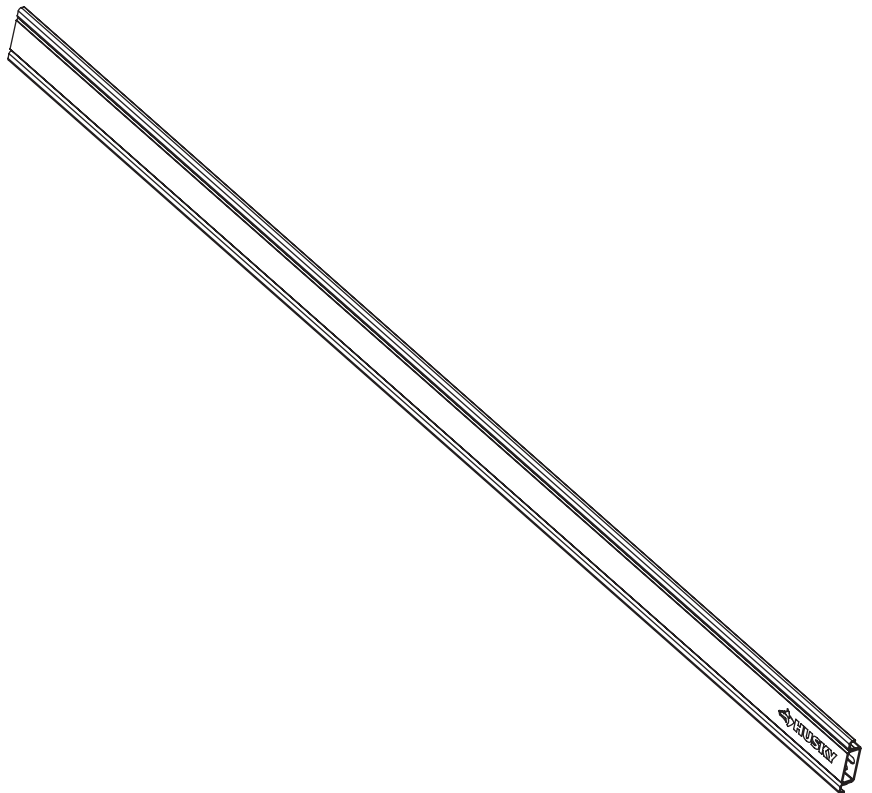

THANK YOU

We appreciate the trust and confidence you have placed in Husky through the purchase of this metal track. We strive to continually create quality products designed to enhance your home. Visit us online to see our full line of products available for your home improvement needs. Thank you for choosing Husky!

Table of Contents

Table of Contents	2	Installation	5
Safety Information	2	Wood Positioning Screws.....	6
Warranty	2	Care & Cleaning	7
Pre-Installation.....	3	Troubleshooting	7
Husky Track Sizes.....	4		

Safety Information

- Husky track or wall products are intended for garage or basement applications.
- Always be aware of noted weight limits of individual Husky accessories.
- Before installing the Husky Track or Husky Wall to basement walls, you must waterproof the basement to avoid damage from mildew. Despite the appearance of dryness, walls that appear dry may actually become damp after covering with Husky Wall products.
- Special attention to all local codes and ordinances should be taken prior to installation of Husky Wall panels.



WARNING: Maximum weight limit is 100 lbs. per linear foot (45.36 kg. per 0.3 linear meter).

Warranty

LIFETIME WARRANTY

If your Husky product ever fails, bring it back and we will replace it free. This full warranty gives you specific rights, and you may also have other rights, which vary state to state. For details, visit your nearby store or call 1-888-HD-HUSKY.

Pre-Installation

TOOLS REQUIRED



HARDWARE INCLUDED

(AA) Track Cap

(BB) Husky Track

(CC) Screws

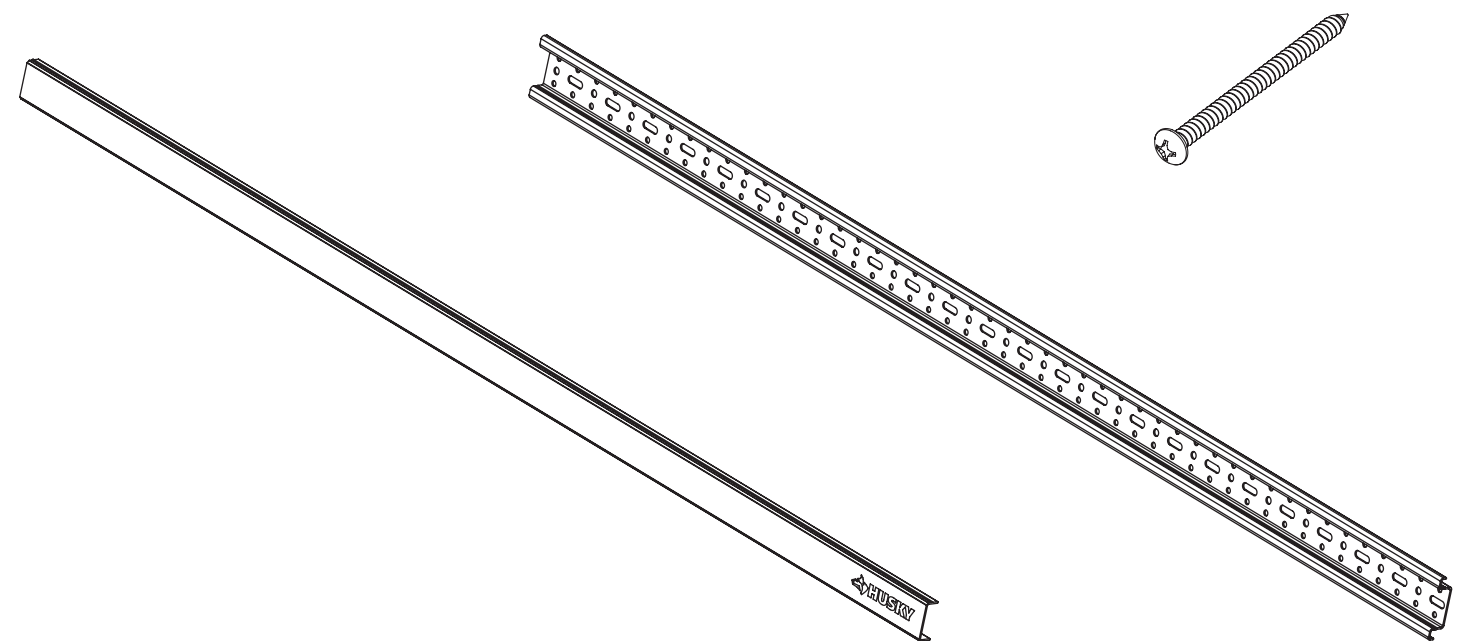

Part	Description	Quantity
AA	Track Cap	X1
BB	Husky Track	X1
CC	Screws (36 IN. Track Starter Pack)	X6
CC	Screws (36 IN. Track Value Pack)	X6
CC	Screws (48 IN. Metal Track)	X8
CC	Screws (84 IN. Metal Track)	X12

Track Sizes

36 IN. / 48 IN. / 84 IN.

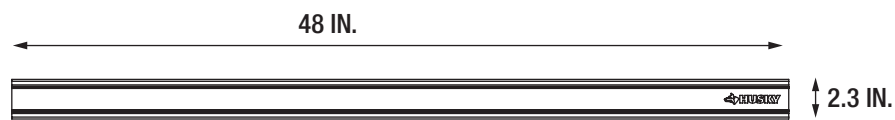
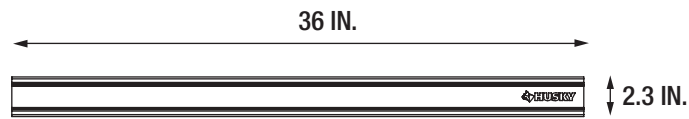

Installation

1 Planning the mounting location

- Mark the desired height of the Track on your wall.
- Draw a level line at this point. With a pencil, mark your stud locations on this level line.

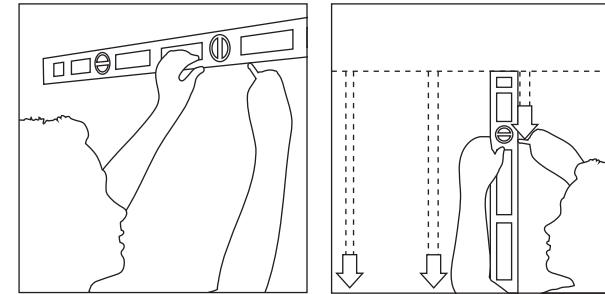

4 Placing the screws

- Place two screws (CC) in all holes labeled "A" from previous step 2. (Each stud should have two screws in it.)

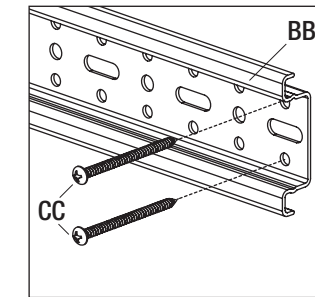

2 Rail must begin and end on studs!



WARNING: Important- Rail must begin and end on studs!

- Mark the top holes at every stud (marked with an A in this drawing). Ensure each stud has two pilot hole marks.
- For details on wood screw positioning and placement see page 6.

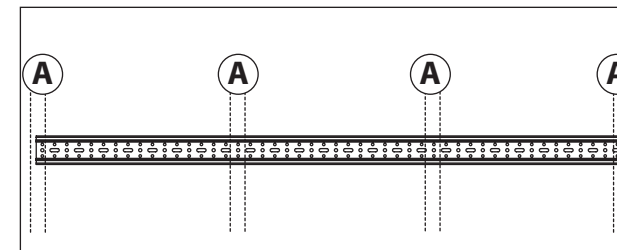

5 Installing multiple Tracks

- If desired, place multiple HuskyTracks (BB) next to one another repeating steps 1- 4.
- Once all HuskyTracks (BB) are anchored to the wall, place "Track Caps" (AA) into corresponding recesses on each Husky Track (BB).

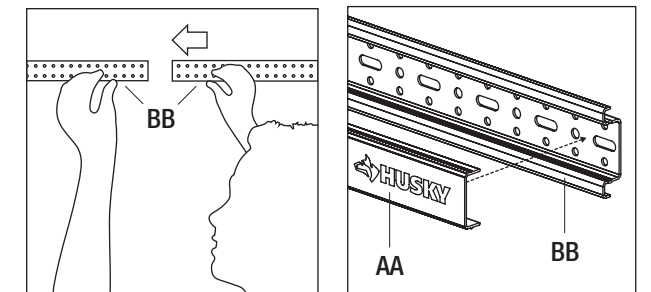

3 Drilling the pilot holes

- Drill 1/8 in. pilot holes in each "A" marking from previous step 2.

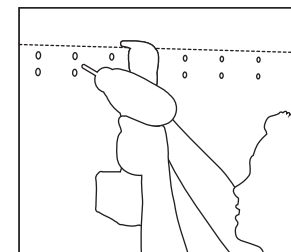

6 Installing accessories

- You can now attach any Husky Track accessories to your Husky Track.

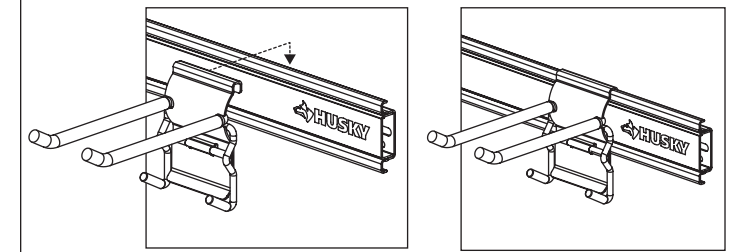

Wood Screw Positioning

(CC) Screws

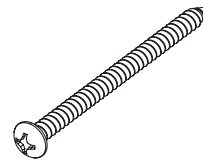

Use two wood screws (CC) per stud.

If end of Husky Track overhangs a stud by more than 2 in., secure with drywall anchor.

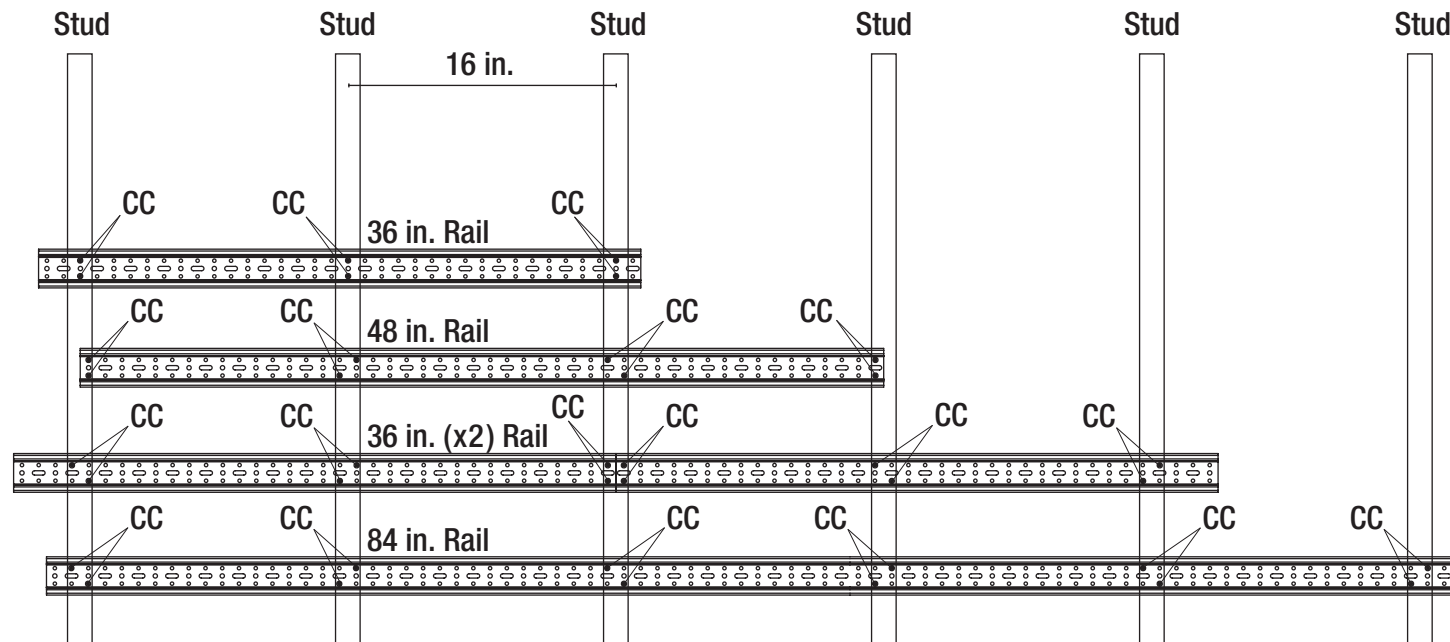

Care and Cleaning

Husky Track is made from the highest quality materials and maintains a clean finish. Simply clean with a mild household cleaner or a feather duster to maintain your track system.

Troubleshooting

What surface can Husky Track or Husky Wall be installed over?

Existing plaster, drywall, and concrete walls. To install over concrete walls use firing strips or a concrete drill bit and “tap con” flathead screws to attach the same way as you would into a stud wall (pre-drilling screw locations).

How do I install Husky Track or Husky Wall over brick wall?

One way is to purchase concrete screws (system comes with hardware for wood) along with a hammer drill.

A second way is to fir out the wall using 2 in. x 2 in. studs. Anchor the studs to the concrete wall, a preferred method spacing them 16 in. off center. For added support when storing heavier items, we recommend installing a plywood sheet over the recently installed studs to help support our panels.

Can I add more Husky Track or Husky Wall when needed?

Yes, you can add more panels to your existing system as your storage needs arise. On each completed end, it is easy to configure connections that allow you to add additional panels as your needs change in the future.

Can I cut Husky Track or Husky Wall?

Yes, Husky Track or Husky Wall can easily be cut using a table saw, jig saw, or a hand saw. For best results use a slider saw capable of making 12 in. or longer cut. Use a 90-tooth blade for a clean finish and then add our trim.



Questions, problems, missing parts? Before returning to the store,
call Husky Customer Service
8 a.m. - 7 p.m., EST, Monday-Friday, 9 a.m. - 6 p.m., EST, Saturday

1-888-HD-HUSKY

HUSKYTOOLS.COM

Retain this manual for future use.