

Galanz

Models: GLCMKA07BKR07 &
GLCMKA07RDR07
Microwave Oven User Manual

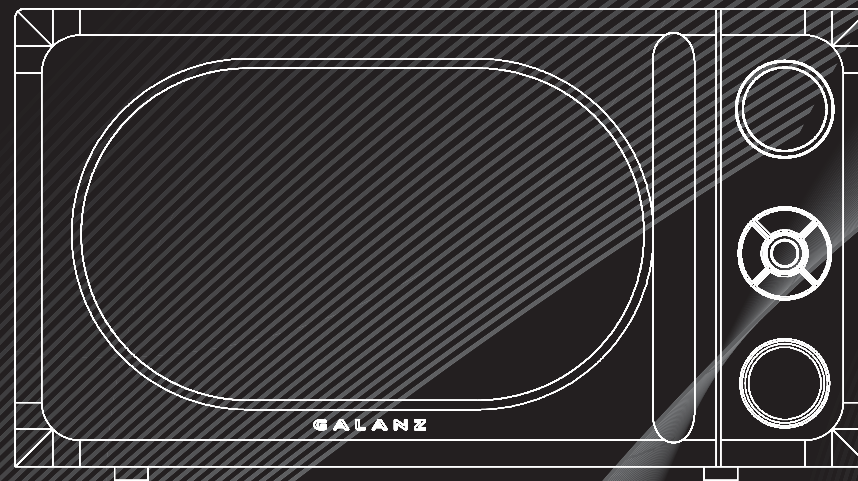

Thank you for purchasing a Galanz product. Please read this manual carefully for correct usage and safety, and keep for future reference. For service, support and warranty information, call 800-562-0738.

CONTENT

CONTENT

PRECAUTIONS TO AVOID POSSIBLE EXPOSURE TO EXCESSIVE MICROWAVE ENERGY	1
CONTENT	1
IMPORTANT SAFETY INSTRUCTIONS	2
GROUNDING INSTRUCTIONS	4
INSTALLATION GUIDE.....	4
COOKING UTENSILS GUIDE	5
SPECIFICATIONS.....	6
PART NAMES	6
CONTROL PANEL.....	7
OPERATION INSTRUCTIONS	8
SETTING THE CLOCK.....	8
QUICK START.....	8
MICROWAVE COOKING.....	8
WEIGHT DEFROST	8
SPEED DEFROST	9
MULTI-STAGE COOKING	9
PRESET	9
CHILD LOCK	10
ECO	10
AUTO COOK.....	10
CLEANING AND CARE.....	10

⚠ IMPORTANT SAFETY INSTRUCTIONS

⚠ **WARNING** To reduce the risk of burns, electric shock, fire, injury to persons or exposure to excessive microwave energy:

- Read all instructions before using the appliance.
- Read and follow the specific "PRECAUTIONS TO AVOID POSSIBLE EXPOSURE TO EXCESSIVE MICROWAVE ENERGY" on page 1.
- This appliance must be grounded. Connect only to properly grounded outlet. See "GROUNDING INSTRUCTIONS" on page 4.
- Do not operate the oven when empty.
- Install or locate this appliance only in accordance with the provided installation instructions.
- Some products such as whole eggs and sealed containers -for example, closed glass jars- are able to explode and should not be heated in this oven.
- Use this appliance only for its intended use as described in this manual. Do not use corrosive chemicals or vapors in this appliance. This type of oven is specifically designed to heat, cook, or dry food. It is not designed for industrial or laboratory use.
- As with any appliance, close supervision is necessary when used by children.
- To reduce the risk of fire in the oven cavity:
 - Do not overcook food. Carefully attend appliance when paper, plastic, or other combustible materials are placed inside the oven to facilitate cooking.
 - Remove wire twist-ties from paper or plastic bags before placing bag in oven.
 - If materials inside the oven should ignite, keep oven door closed, turn oven off, and disconnect the power cord or shut off power at the fuse or circuit breaker panel.
 - Do not use the cavity for storage purposes. Do not leave paper products, cooking utensils or food in the cavity when not in use.
- Liquids, such as water, coffee, or tea are able to be overheated beyond the boiling point without appearing to be boiling due to surface tension of the liquid. Visible bubbling or boiling when the container is removed from the microwave oven is not always present. **THEIS COULD RESULT IN VERY HOT LIQUIDS SUDDENLY BOILING OVER WHEN A SPOON OR OTHER UTENSIL IS INSERTED INTO THE LIQUID.** To reduce the risk of injury to person:
 - Do not overheat the liquid.
Stir the liquid both before and halfway through heating it.
 - Do not use straight-sided containers with narrow necks.
 - After heating, allow the container to stand in the microwave oven for a short time before removing the container.
 - Use extreme care when inserting a spoon or other utensil into the container.
- Do not heat oil or fat for deep-frying. It is difficult to control the temperature of oil in microwave oven.
- Do not cover or block any openings on the appliance.
- Do not operate this appliance if it has a damaged cord or a plug, if it is not working properly or if it has been damaged or dropped.
- Do not immerse cord or plug in water. Keep cord away from heated surface. Do not let cord hang over edge of table or counter.
- This appliance should be serviced only by qualified service personnel, contact nearest authorized service facility for examination, repair, or adjustment.
When cleaning surfaces of door and oven that comes together on closing the door, use only mild, nonabrasive soaps, or detergents applied with a sponge or soft cloth.
- Oversized food or oversized metal utensils should not be



IMPORTANT SAFETY INSTRUCTIONS

inserted in a microwave/toaster oven as they may create a fire or risk of electric shock.

- Do not store or use this appliance outdoors. Do not use this product near water, for example, near a kitchen sink, in a wet basement, near a swimming pool, or similar locations.
- Do not clean with metal scouring pads. Pieces can burn off the pad and touch electrical parts involving a risk of electric shock.
- Do not use paper products when appliance is operated in the toaster mode.
- Do not store any materials, other than manufacturer's recommended accessories, in this oven when not in use.
- Do not cover racks or any other part of the oven with metal foil. This will cause overheating of the oven.
- This equipment has been tested and found to comply with Part 18 of the FCC Rules. Operation is subject to the following two conditions: (1) This device may not cause harmful interference, and (2) this device must accept any interference received, including interference that may cause undesired operation.

CAUTION: Changes or modifications not expressly approved by the party responsible for compliance could void the user's authority to operate the product.

- This equipment generates, uses and can radiate radio frequency energy and, if not installed and used in accordance with the instructions, may cause harmful interference to radio communications. However, there is no guarantee that interference will not occur in a particular installation. If this equipment does cause harmful interference to radio or television reception, which can be determined by turning the equipment off and on, the user is encouraged to try to correct the interference by one or more of the following measures:
correct the interference by one or more of the following

measures:

- Reorient or relocate the receiving antenna.
- Increase the separation between the equipment and receiver.
- Connect the equipment into an outlet on a circuit different from that to which the receiver is connected.
- Consult the dealer or an experienced radio/TV technician for help.

SAVE THESE INSTRUCTIONS

GROUNDING INSTRUCTIONS

⚠ WARNING Improper use of the grounding plug can result in a risk of electric shock.

The event of an electrical short circuit, grounding reduces risk of electric shock by providing an escape wire for the electric current. This appliance is equipped with a cord having a grounding wire with a grounding plug. The plug must be plugged into an outlet that is properly installed and grounded.

Consult a qualified electrician or serviceman if the grounding instructions are not completely understood, or if doubt exists as to whether the appliance is properly grounded, and if it is necessary to use an extension cord, use only a 3-wire extension cord that has a 3-blade grounding plug and a 3-slot receptacle that will accept the plug on the appliance. The marked rating of the extension cord shall be equal to or greater than the electrical rating of the appliance.

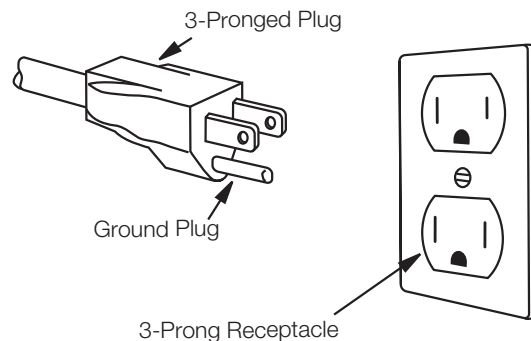

Electrical Requirements

The electrical requirements are a 120 volt 60 Hz, AC only, 20 amp. It is recommended that a separate circuit serving only the oven be provided. The oven is equipped with a 3-prong grounding plug. It must be plugged into a wall outlet properly installed and grounded.

Power Cord

- A short power supply cord is provided to reduce the risks resulting from becoming entangled in or tripping over a longer cord.
- Longer cord sets or extension cords are available and may be used if care is exercised in their use.
- If long cord or extension cord is used:
 - The marked electrical rating of the cord set or extension cord should be at least as great as the electrical rating of the appliance.
 - The extension cord must be a grounding-type 3-wire cord, and the longer cord should be arranged so that it will not drape over the counter top or table top where it can be pulled on by children or tripped over unintentionally.

INSTALLATION GUIDE

INSTALLATION GUIDE

- Make sure that all the packing materials are removed from the inside of the door.
- This microwave oven must be placed on a flat.
- For correct operation, the oven must have sufficient airflow. Allow minimum 20cm of free space necessary above the top surface of the oven and 5cm at both sides. The microwave oven rear plate must be placed close to the wall. Do not cover or block any openings on the appliance. Do not remove feet.
- Do not operate the oven without glass tray, roller support, and shaft in their proper positions.
- Make sure that the power cord is undamaged and does not run under the oven or over any hot or sharp surface.
- The socket must be readily accessible so the microwave oven can be easily unplugged in an emergency.

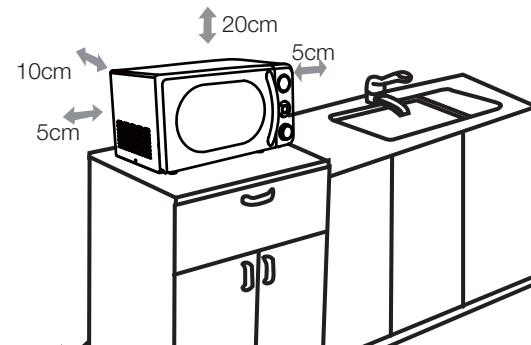

COOKING UTENSILS GUIDE



This section lists which utensils can be used in this microwave, which have limited use for short periods, and which should not be used in this microwave.

RECOMMENDED ✓

Microwave browning dish — Use to brown the exterior of small items such as steaks, chops, or pancakes. Follow the directions provided with your browning dish.

Microwaveable plastic wrap — Use to retain steam. Leave a small opening for some steam to escape and avoid placing it directly on the food.

Paper towels and napkins — Use for short-term heating and covering; these absorb excess moisture and prevent spattering. Do not use recycled paper towels, which may contain metal and could ignite.

Glass and glass-ceramic bowls and dishes — Use for heating or cooking.

Paper plates and cups — Use for short-term heating at low temperatures. Do not use recycled paper, which contain metal and could ignite.

Wax paper — Use as a cover to prevent spattering.

Thermometers — Use only those labeled "Microwave Safe" and follow all directions.

Check the food in several places. Conventional thermometers may be used on microwave food once the food has been removed from the oven.

LIMITED USE ✗

Aluminum foil — Use narrow strips of foil to prevent overcooking of exposed areas.

Using too much foil can damage your oven, so be careful. You should keep distance of 1 inch (2.54cm) between aluminum foil and cavity.

Ceramic, porcelain, and stoneware — Use these if they are labeled "Microwave Safe". If they are not labeled, test them to make sure they can be used safely.

Plastic — Use only if labeled "Microwave Safe". Other plastics can melt.

NOT RECOMMENDED ⊘

Glass jars and bottles — Regular glass is too thin to be used in a microwave. It can shatter and cause damage and injury.

Paper bags — These are a fire hazard, except for popcorn bags bagsidue on food.

SPECIFICATIONS

SPECIFICATIONS

Power Consumption	120V/60Hz, 1200W(Microwave)
Output	700W
Operation Frequency	2450MHz
Outside Dimensions(H x W x D)	10 5/16 × 17 13/16 × 13 3/4 in.
Oven Capacity	0.7cu.ft.
Net Weight	Approx.23.1 lbs

PRODUCT DIAGRAM

PRODUCT DIAGRAM

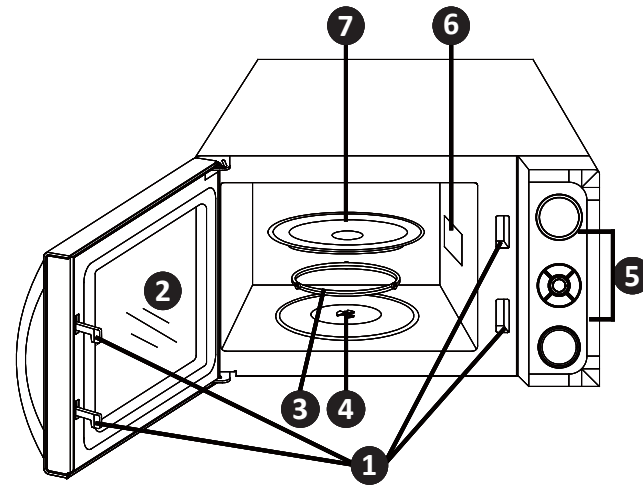

- ① Door Safety Lock System
- ② Oven Window
- ③ Roller Ring
- ④ Shaft
- ⑤ Control Panel
- ⑥ Wave Guide (Please do not remove the mica plate covering the wave guide)
- ⑦ Glass Tray

CONTROL PANEL

CONTROL PANEL

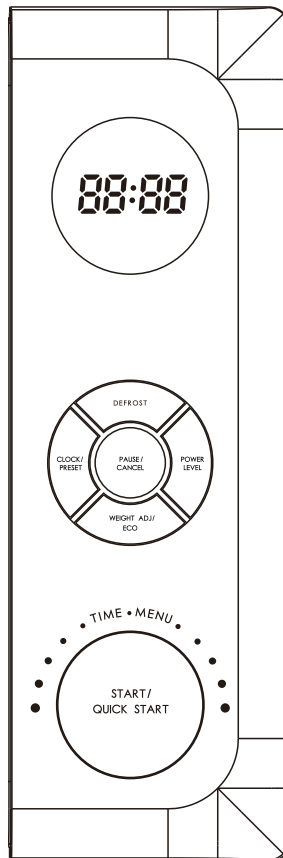

■ DISPLAY

Cooking time, power, indicators and clock time are displayed.

■ POWER LEVEL

Use to set power level. To check power level during time cooking, press POWER LEVEL pad.

■ DEFROST

Press the pad twice to set weight defrost program. The defrosting time and power level are automatically set once the food weight is programmed. Press the pad once to set defrost program based on time enter.

■ TIME/MENU(knob)

Turn the knob to input popular food menu, clock time, cooking time.

■ PAUSE/CANCEL

Press to clear the selected power level, cook or defrost times that previously programmed. Press to set child lock.

■ START/QUICK START(the knob)

Press to start the cooking or defrosting programs. Press to set quick start program.

■ CLOCK/PRESET

Press to set clock or preset program.

■ WEIGHT ADJ./ECO

Press to set food weight or amount and set eco function.

OPERATION INSTRUCTIONS



- When the oven first plugged in, beep will sound and the display will show "CLOCK" and "1:00".
- In the process of setting, broke about 25 seconds the oven will return to standby mode.
- During cooking program, press PAUSE/CANCEL once to pause the program, and then press START/QUICK START to resume. Press PAUSE/CANCEL twice to cancel the program.
- After ending cooking, the screen will display End with sound every two minutes until user press any pad or open the door.

Setting the Clock



This is a 12 or 24 hour clock. you can choose to set the clock time in 12 or 24 hour cycle by pressing the CLOCK/PRESET pad in standby mode.

In standby mode, press CLOCK/PRESET pad once or twice to choose 12 or 24 hour clock.

- 1** Turn TIME/MENU to indicate the hour digit.
- 2** Press CLOCK/PRESET pad once.
- 3** Turn TIME/MENU knob to indicate the minute digit.
- 4** Press CLOCK/PRESET to confirm the setting.

NOTE: During cooking, you can check the current time of the clock by pressing CLOCK/PRESET pad.

QUICK START



The oven will operate at HIGH power (100% power output) for quick start cooking program. In standby mode, just press the START/QUICK START pad a number of times to set cooking time, the oven starts working automatically at full power. The longest cooking time is 10 minutes.

NOTE: During cooking, you can add cooking time by pressing START/QUICK START pad.

OPERATION INSTRUCTIONS

Microwave Cooking

To cook with microwave, time and power level should be set. The longest cooking time is 99 minutes 99 seconds.

Suppose you want to cook for 5 minutes at 60% of microwave power.

- 1** Press POWER LEVEL pad repeatedly to select cooking power level.
- 2** Turn TIME/MENU knob clockwise to enter cooking time. The longest cooking time is 95 minutes.
- 3** Press START/QUICK START pad to confirm.

Select power level by pressing the POWER LEVEL pad.

PRESS POWER LEVEL PAD	COOKING POWER(DISPLAY)
Once	100% (100)
Twice	80% (80)
3 times	60% (60)
4 times	40% (40)
5 times	20% (20)
6 times	0% (00)

SPEED DEFROST

- 1** In standby mode, press DEFROST pad once.
- 2** Turn TIME/MENU knob to enter defrosting time. The longest defrosting time is 95 minutes.
- 3** Press START/QUICK START pad to confirm.

NOTE: During defrosting program, the system will pause and sound beeps to remind user to turn food over, and then press START/QUICK START to resume the defrosting.

OPERATION INSTRUCTIONS

WEIGHT DEFROST



The time and the defrosting power are adjusted automatically once the weight of food is programmed. The food weight ranges from 4oz to 4LB.

- 1** In standby mode, press DEFROST pad twice.
- 2** Press WEIGHT ADJ./ECO pad to enter weight of food.
- 3** Press START/QUICK START pad to confirm.

NOTE: During defrosting program, the system will pause to remind you to turn over the food, after that, presses START/QUICK START to resume defrosting.

Weight must be in pounds and ounces. If label gives weight in pounds only, change the fraction of a pound to ounces using the following chart.

Converting Fractions of a Pound to Ounces.

Fractions of a pound	Ounces
Less than .03	0
.03 to .09	1
.10 to .15	2
.16 to .21	3
.22 to .27	4
.28 to .34	5
.35 to .40	6
.41 to .46	7
.47 to .53	8
.54 to .59	9
.60 to .65	10
.66 to .71	11
.72 to .78	12
.79 to .84	13
.85 to .90	14
.91 to .97	15
above .97	go to next even

OPERATION INSTRUCTIONS

MULTI-STAGE COOKING



Your oven can be programmed for up to 3 automatic cooking sequences.

Suppose you want to set the following cooking program.

Microwave-cooking



Microwave-cooking (with lower power level)

- 1** Set the first stage of microwave cooking program. Do not press START/QUICK START pad.
- 2** Set the second stage of microwave cooking program.
- 3** Press START/QUICK START pad to confirm.

NOTE: Quick start, speed defrost, weight defrost and auto menus can't be set in multi-stage cooking.

PRESET



This function allows you to set the oven to start a cooking program in a later time.

Open the door and place the food into the oven, close it.

Enter the desired cook program (except quick start, weight defrost and speed defrost).

- 1** Press CLOCK/PRESET pad once.
- 2** Turn the TIME/MENU knob to set hour digit.
- 3** Press CLOCK/PRESET pad once.
- 4** Turn the TIME/MENU knob to set minute digit.

Press CLOCK/PRESET pad to confirm.

NOTE: In preset mode, you can check the preset time by pressing CLOCK/PRESET pad, and you can cancel preset program by pressing PAUSE/CANCEL pad when the display show preset time.

OPERATION INSTRUCTIONS

CHILD LOCK



The child lock prevents unsupervised operation by children.

To set the child lock: In standby mode, press and hold the PAUSE/CANCEL pad for 3 seconds, a beep sounds and lock indicator lights. In the lock state, all pads are disabled.

To cancel the child lock: Press and hold the PAUSE/CANCEL pad for 3 seconds, a beep sounds and lock indicator on display goes off.

ECO



In standby mode, press the WEIGHT ADJ./ECO pad once to turn off the display screen, and then press any pad to turn on the display screen.

AUTO COOK



For the following foods or cooking operation, you do not need to input cooking power and time. It is sufficient to indicate the type of food that you want to cook as well as the weight or shares of this food.

The oven starts to work after you press the START/QUICK START pad.

Auto cook menus:



In standby mode, turn the TIME/MENU knob anticlockwise once and then turn it clockwise to select the menu code which you want to cook.

- 1 Press WEIGHT ADJ./ECO pad to enter food weight or shares.
- 2 Press START/QUICK START pad to confirm.

CODE	AUTO MENU	The result of auto cooking depends on factors such as the shape and size of food, your personal preference as to the doneness of certain foods and even how well you happen to place food in the oven. If you find the result at any rate not quite satisfactory, please adjust the cooking time a little bit accordingly.
A-1	Beverage (7.0 oz/cup)	
A-2	Potato (8.0oz/share)	
A-3	Reheat (oz)	
A-4	Frozen Dinner (oz)	
A-5	Popcorn (3.5 oz.)	
A-6	Pizza (oz)	

CLEANING AND CARE

- Turn off the oven and unplug the power cord from the wall when cleaning.

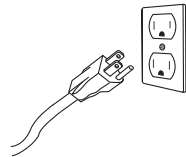

- Keep the inside of the oven clean. When food splatters or spilled liquids adhere to oven walls, wipe with a damp cloth. Mild detergents may be used if the oven gets very dirty. Avoid using spray or other harsh cleaners. They may stain, streak or dull the door surface.

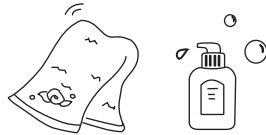

- The outside of the oven should be cleaned with a damp cloth. To prevent damage to the operating parts inside the oven, water should not be allowed to seep into the ventilation openings.
- Wipe the door and window on both sides, the door seals and adjacent parts frequently with a damp cloth to remove any spills or splatters. Do not use abrasive cleaner.
- Do not allow the control panel to become wet. Clean with a soft, damp cloth. When cleaning the control panel, leave oven door open to prevent oven from accidentally turning on.

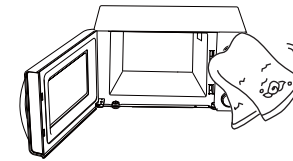

- If steam accumulates inside or around the outside of the oven door, wipe with a soft cloth. This may occur when the microwave oven is operated under high humidity condition. And it is normal.
- It is occasionally necessary to remove the glass tray for cleaning. Wash the tray in warm sudsy water or in a dishwasher.

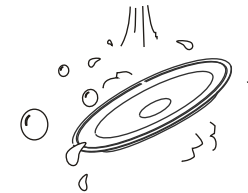

- The roller ring and oven floor should be cleaned regularly to avoid excessive noise. Simply wipe the bottom surface of the oven with mild detergent. The roller ring may be washed in mild, soapy water or in a dishwasher. When removing the roller ring, be sure to replace it in the proper position.

CLEANING AND CARE

CLEANING AND CARE

- Remove odors from your oven by combining a cup of water with the juice and skin of one lemon in a microwaveable bowl. Microwave for 5 minutes. Wipe thoroughly and dry with a soft cloth.
- If the light bulb burns out, please contact customer service to have it replaced.
- The oven should be cleaned regularly and any food deposits should be removed. Failure to maintain the oven in a clean condition could lead to deterioration of surface that could adversely affect the life of the unit and could possibly result in a hazardous situation.
- Please do not dispose of this appliance into the domestic rubbish bin; it should be disposed to the particular disposal center provided by the municipalities.

LIMITED WARRANTY

LIMITED WARRANTY

This warranty applies to products purchased and used in Canada. This is the only express warranty for this product and is in lieu of any other warranty.

This product is warranted to be free from defects in material and workmanship for a period of one (1) year from the date of original purchase, except as noted below. During this period, we will repair or replace this product at our option.

This warranty extends only to the original consumer purchaser and does not cover a defect resulting from abuse, misuse, neglect including failure to clean product regularly in accordance with manufacturer's instructions, use for commercial purposes, or any use not in conformity with the printed directions.

We exclude all claims for special, incidental, and consequential damages caused by breach of express or implied warranty. All liability is limited to the amount of the purchase price. Every implied warranty, including any statutory warranty of merchantability or fitness for a particular purpose, is disclaimed except to the extent prohibited by law, in which case such warranty is limited to the duration of this written warranty. This warranty gives you specific legal rights. You may have other legal rights that vary depending on where you live. Some states do not allow limitations on implied warranties or special, incidental, or consequential damages, so the foregoing limitations may not apply to you.

If you have a claim under this warranty, please call our CUSTOMER SERVICE NUMBER. For faster service please have model number and serial number ready for operator to assist you.

CUSTOMER SERVICE NUMBER
800-562-0738

KEEP THIS NUMBER FOR FUTURE REFERENCE!
WARRANTOR: GUANGDONG GALANZ MICROWAVE
ELECTRICAL APPLIANCES MANUFACTURING
CO.,LTD, GUANGDONG, P.R.C. 528429

Galanz

©2019 Galanz Americas Limited Company