

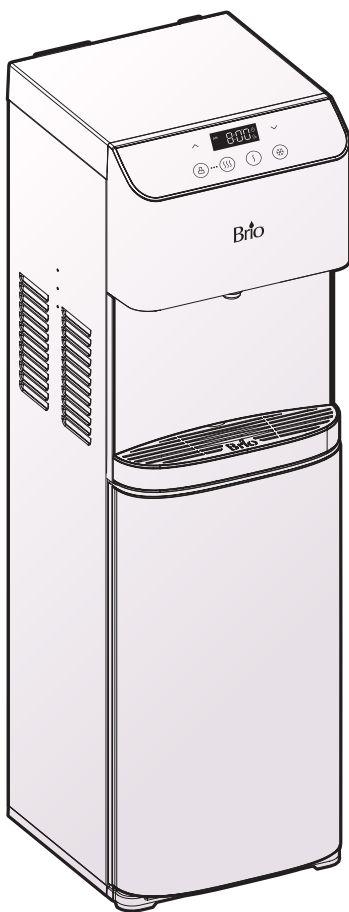

# WATER DISPENSER

MODEL NO. CLBL720SC



Thank you for purchasing a Brio® water cooler

Please read and understand this manual before operating your water dispenser  
Retain this manual for future use

# TABLE OF CONTENTS

<b>SAFETY INFORMATION</b> .....	<b>3</b>
<b>INTENDED USE</b> .....	<b>4</b>
<b>PRODUCT FEATURES</b> .....	<b>4</b>
Touch Panel Description .....	5
Product Dimensions .....	5
Operational Specifications .....	5
<b>INSTALLATION</b> .....	<b>6</b>
Determine Installation Location .....	6
Install the Drip Tray and Grid .....	6
Connect a Water Bottle .....	6
<b>OPERATION</b> .....	<b>7</b>
Turn the Dispenser On/Off .....	7
Set the Clock .....	7
Set the Cold Temperature Setting .....	8
Set the Hot Temperature Setting .....	8
Dispense Cold or Room Temperature Water .....	8
Dispense Hot Water and Activate Child Safety Lock .....	8
Change the Water Bottle .....	8
<b>TROUBLESHOOTING</b> .....	<b>9</b>
<b>CLEANING AND MAINTENANCE</b> .....	<b>10</b>
Use the Self-Cleaning Ozone Feature .....	10
Care and Maintenance .....	10
<b>WARRANTY</b> .....	<b>11</b>

# SAFETY INFORMATION

**WARNING:** To reduce risk of injury and property damage, you must read this entire guide before assembling, installing and operating the dispenser.

**WARNING:** This product dispenses water at very high temperatures. Failure to use properly can cause personal injury. When operating this dispenser, always exercise basic safety precautions, including the following:

- Prior to use, this dispenser must be properly assembled and installed in accordance with this manual.
- For indoor use only. Keep the water dispenser in a dry place away from direct sunlight. Do NOT use outdoors.
- Install and use only on a hard, flat and level surface.
- Do NOT place the water dispenser in an enclosed space or cabinet.
- Do NOT operate the dispenser in the presence of explosive fumes.
- Use only properly grounded outlets.
- Do not use an extension cord.
- Always grasp the plug and pull straight out from the outlet. Never unplug by pulling on the power cord.
- Do NOT use the dispenser if the cord becomes frayed or otherwise damaged. If the supply cord is damaged, it must be replaced by the manufacturer, its service agent or similarly qualified persons in order to avoid a hazard.
- To protect against electric shock, do NOT immerse cord, plug, or any other part of the dispenser in water or other liquids.
- Do not use this dispenser with water that is microbiologically unsafe or of unknown quality.
- Water dispenser is compatible with 3- or 5-gallon (12- or 19- liter) water bottles.
- Clean up all water spills after loading or unloading water bottles from the dispenser.
- Ensure the water dispenser is unplugged prior to cleaning.
- Never allow children to dispense hot water without proper and direct supervision. Unplug the unit to prevent unsupervised use by children.
- Service should be performed only by a certified technician.
- The appliance must not be cleaned by a water jet and is not suitable for installation in an area where a water jet could be used.

**WARNING:** Keep ventilation openings, in the dispenser enclosure or in the built-in structure, clear of obstruction.

**WARNING:** Do not use mechanical devices or other means to accelerate the defrosting process, other than those recommended by the manufacturer.

- This dispenser should work under environment of temperatures from 4°C~40°C (39°F~104°F) and humidity ≤90%.
- Never turn the dispenser upside down or lean it more than 45°.
- After turning the dispenser off, allow the dispenser to sit idle for 3 minutes before turning on again.

# INTENDED USE

This dispenser is intended to be used in household and similar applications such as:

- Staff kitchen areas, offices, and other working environments
- Farm houses
- Clients in hotels, motels and other residential type environments
- Bed and breakfast type environments
- Catering and similar non-retail applications

This dispenser is not intended for use by persons (including children) with reduced physical, sensory or mental capabilities, or lack of experience and knowledge, unless they have been given supervision or instruction concerning use of the appliance by a person responsible for their safety.

# PRODUCT FEATURES

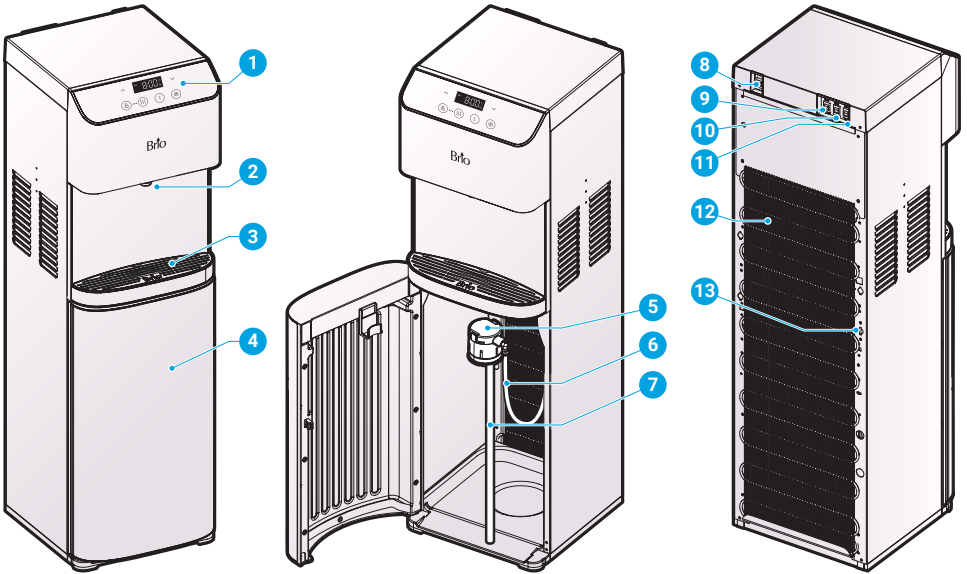

PART	DESCRIPTION
1	Touch panel display
2	Water tap
3	Drip tray
4	Water bottle cabinet
5	Bottle adapter
6	Water line
7	Bottle adapter tube

PART	DESCRIPTION
8	Self-cleaning switch
9	Nightlight switch
10	Cold water switch
11	Hot water switch
12	Condenser
13	Drain outlet

## Touch Panel Description

1. Up arrow button – Press to set the time on the clock and increase temperature settings.
2. Clock/Temperature display – Shows the time and water temperature setting when setting the temperature of the hot or cold water. Also indicates when a water bottle needs to be replaced and when the dispenser is in self-cleaning mode.
3. Down arrow button – Press to set the time on the clock and decrease temperature settings.
4. Lock button – Press to lock the hot water button and to confirm temperature and time settings.
5. Hot water button – Press to dispense hot water.
6. Ambient water button – Press to dispense room temperature water.
7. Cold water button – Press to dispense cold water.

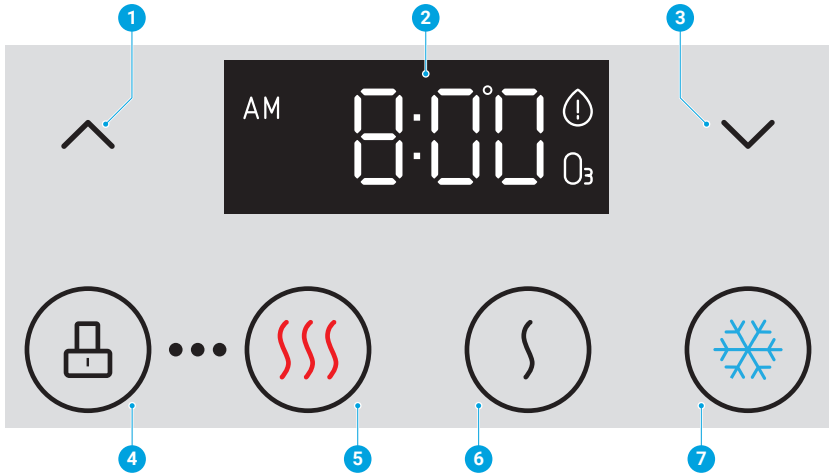

## Product Dimensions

HEIGHT	WIDTH	DEPTH
104.0 cm (40.9 in.)	31.0 cm (12.2 in.)	34.0 cm (13.4 in.)

## Operational Specifications

**CAUTION:** This unit dispenses water at temperatures that can cause severe burns. Avoid direct contact with hot water. Keep children and pets away from unit while dispensing. Never allow children to dispense hot water without proper and direct supervision. Unplug unit to prevent unsupervised use by children.

	TEMPERATURE	TANK CAPACITY	FLOW RATE
DISPENSING COLD WATER	39°-59°F / 4°-15°C	2.5 L/H	1.2 L/min
DISPENSING HOT WATER	174°-194°F / 79°-90°C	4 L/H	1.2 L/min

# INSTALLATION

## 1. Determine Installation Location

- A. Place the dispenser upright.
- B. Locate the dispenser on a hard and level surface in a cool shaded location near a grounded wall outlet.  
**NOTICE:** Do NOT plug in the power cord until the entire installation section is completed.
- C. Position the back of the dispenser no closer than 20 cm (8 in.) from a wall and permit free airflow between the wall and water dispenser.

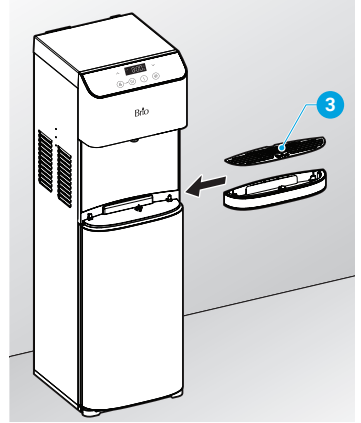

## 2. Install the Drip Tray and Grid

- A. Unwrap the drip tray (3) from the packaging material and slide it onto the dispenser until it is secure in place.

## 3. Connect a Water Bottle

**IMPORTANT:** To prevent dry heating, do not turn on the heating and cooling switches until you complete the steps in this procedure.

- A. Remove the plastic wrapping and cap from the water bottle and clean the new bottle with a clean cloth.
- B. Open the cabinet door and feed the bottle adapter tube (7) into the water bottle. Ensure the tube hits the bottom of the bottle.
- C. For a 5-gallon bottle, place the bottle adapter (5) over the neck of the water bottle and press securely into place.
- D. For a 3-gallon bottle, press down on the two tabs on top of the bottle adapter (5) and slide the cap down the probe tubing to adjust the bottle adapter to fit.

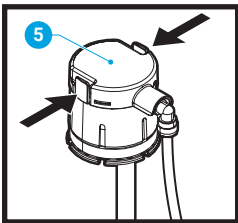
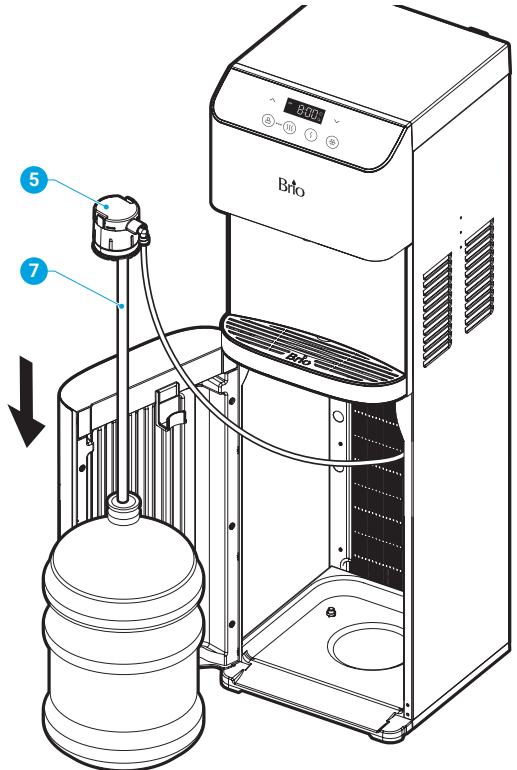

- E. Slide the water bottle into the dispenser cabinet and close the door.
- F. Wait 5 minutes for the water tanks to fill with water before attempting to use the dispenser.
- G. Remove air from the tanks by placing a cup under each water tap and drain at least 4 cups (1 liter) of water before initial use.

**NOTE:** Water will not pump from the bottle until the door is completely closed.

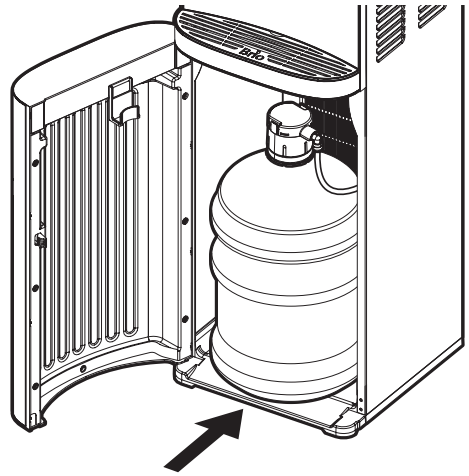

## OPERATION

**IMPORTANT:** This unit has been tested and sanitized prior to packing and shipping. During transit, dust and odors can accumulate in the tank and lines. Dispense and dispose at least one quart of water prior to drinking any water.

### Turn the Dispenser On/Off

**IMPORTANT:** Before you turn the dispenser on and activate the hot and cold switches, ensure a bottle is installed.

1. Plug in the dispenser and turn the On/Off switch to On.
2. Run water through the tap until water begins to dispense.
3. To power on the cooling system, flip the cooling switch on the back of the dispenser to the On position. The cold water button on the front of the dispenser illuminates in blue indicating that the dispenser is cooling water. The light turns off when the cooling process is complete.
4. To power on the heating system, flip the heating switch on the back of the dispenser to the On position. The hot water button on the front of the dispenser illuminates in red indicating that the dispenser is heating water. The light turns off when the heating process is complete.

### Set the Clock

1. Press and hold the up and down arrow buttons for 3 seconds until the clock display begins to blink.
2. Press the cold water button to set the minute and the hot water button to set the hour. Use the up and down arrow buttons to scroll until the correct minute/hour is displayed.
3. Press the hot water lock button when finished.

## Set the Cold Temperature Setting

1. Press and hold the down arrow button for 3 seconds until the cold water button starts to blink and the current cold water temperature appears on the display.
2. Use the up and down arrow buttons to scroll to your desired cold water temperature. The range is 39°F to 59°F (4°C to 15°C).
3. Press the lock button when finished. The temperature stops blinking and the time is displayed.

## Set the Hot Temperature Setting

1. Press and hold the up arrow button for 3 seconds until the hot water button starts to blink and the current hot water temperature appears on the display.
2. Use the up and down arrow buttons to scroll to your desired hot water temperature. The range is 174°F to 194°F (79°C to 90°C).
3. Press the lock button when finished. The temperature stops blinking and the time is displayed.

## Dispense Cold or Room Temperature Water

**NOTE:** Water will take approximately 1 hour after plugging in and turning on to become completely chilled.

1. Place a drinking glass or container under the tap and press the cold water button to dispense cold water or the ambient water button to dispense room temperature water.
2. Release the button when your container is full.

## Dispense Hot Water and Activate Child Safety Lock

**CAUTION:** This unit dispenses water at temperatures that can cause severe burns. Avoid direct contact with hot water. Keep children and pets away from the unit while dispensing. Never allow children to dispense hot water without proper and direct supervision. Disable the heating feature by switching the heating convenience switch to the Off position.

**NOTE:** Water will take approximately 15-20 minutes after plugging in and turning on to reach its hottest temperature.

1. This water dispenser is equipped with a child safety feature in order to prevent inadvertent dispensing. To disable the child safety lock feature, press the lock button.
2. To dispense hot water, place a drinking glass or container under the tap and press the hot water button.
3. Release the button when your container is full.

## Change the Water Bottle



**CAUTION:**

Do not dispense hot, cool or cold water if the change water bottle icon is flashing on the display as you could empty the tanks and cause the dispenser to overheat.

When the bottle indicator icon on the top-right corner of the display begins to blink, it is time to replace your empty water bottle with a new water bottle:

1. Open the dispenser cabinet door and slide the empty bottle out of the cabinet.
2. Remove the bottle adapter from the empty bottle and let the probe drip into the bottle. Once dripping has stopped, place the bottle adapter on the hanger and set the empty bottle aside.
3. Follow the steps in **Connect a Water Bottle** to install your new water bottle.
4. Recycle the empty bottle at your local exchange center to receive your next bottle at a discount.



# TROUBLESHOOTING

PROBLEM	SOLUTION
The cold water is not cold.	<ul style="list-style-type: none"><li>• It takes up to one hour after setup to dispense cold water.</li><li>• Make sure the power cord is properly connected to a working outlet.</li><li>• Make sure the back of the dispenser is at least 20 cm from a wall and there is free airflow on all 20 cm sides of the dispenser.</li><li>• Make sure green power switch on back of dispenser is On.</li><li>• If water still isn't cold, call customer service at +1 844-257-4103 for assistance.</li></ul>
The hot water is not hot.	<ul style="list-style-type: none"><li>• It takes 15-20 minutes after setup to dispense hot water.</li><li>• Make sure the power cord is properly connected to a working outlet.</li><li>• Make sure red power switch on back of dispenser is On.</li></ul>
The nightlight is not working.	<ul style="list-style-type: none"><li>• Make sure the power cord is properly connected to a working outlet</li><li>• Make sure the nightlight power switch on back of dispenser is On.</li></ul>
The dispenser is noisy.	<ul style="list-style-type: none"><li>• Ensure the dispenser is located on a level surface.</li><li>• The heating tube may be generating a slight noise. This is normal.</li></ul>
The bottle is leaking.	<ul style="list-style-type: none"><li>• Ensure the bottle is installed correctly.</li><li>• Check to see if the bottle is cracked or broken. If so, replace the bottle.</li></ul>
The dispenser is not dispensing water.	<ul style="list-style-type: none"><li>• Check to see if the bottle is empty and replace with a new bottle if necessary.</li><li>• There may still be air in the tank. Press and hold the water taps to remove air until water begins to flow.</li></ul>

# CLEANING AND MAINTENANCE

## Use the Self-Cleaning Ozone Feature

It is highly recommended that you use the self-cleaning feature on a weekly basis to sanitize tanks and water lines.

To activate the self-cleaning cycle, press in the self-cleaning switch (8), hold for 5 seconds, and release.

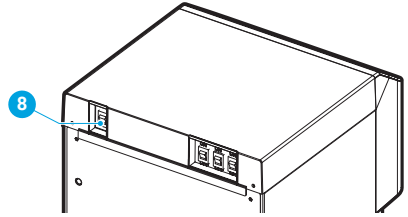

The Ozone icon on the bottom-right corner of the display will begin blinking, indicating the cleaning process is underway.

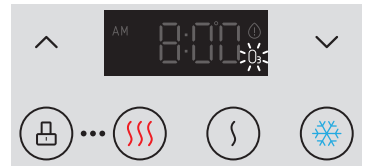

During the cleaning cycle, ozone is produced and injected into the water system. This ozone kills bacteria and biofilms typically found in water dispensers. By the time the cleaning cycle ends, the ozone is converted to harmless oxygen and emitted into the air.

**IMPORTANT:** The cycle takes 90 minutes to complete. During this time do not dispense and drink the water. Doing so may result in an odd taste. For your convenience, we recommend that you do this during a period when the dispenser is not in use, such as overnight hours or when staff is away from the office. During the cycle you may smell a faint trace of ozone.

## Care and Maintenance

- Keep this dispenser in a dry and cool place and avoid direct sunshine.
- Ensure the back of the dispenser is at least 20 cm (8 in.) away from the wall.
- Never put the dispenser on paper or foam, which may store water and then cause creepage. Never put anything flammable beside this machine.
- Do not use the dispenser outdoors or in a place that can be splashed by water.
- If the dispenser is not in use for longer than a 24-hour period, turn off the heating switch or the refrigerating switch to save power and drain any remaining water.
- Clean your cabinet, controls, bottle probe and spout each time you change your water bottle. Use a clean soft cloth and a food grade sanitizer or bleach.
- Empty and clean the drip tray, grid and float as needed.

# WARRANTY

Brio ("Vendor") warrants to the original purchaser of the Brio Water Coolers (the "Product"), and to no other person, that if the Product is assembled and operated in accordance with the printed instructions accompanying it, then for a period of one (1) year from the date of purchase, all parts in the Product shall be free from defects in material and workmanship. This Limited Warranty shall be limited to repair or replacement of parts, which prove defective under normal use and service and which Vendor shall determine in its reasonable discretion upon examination to be defective. To take advantage of this Limited Warranty, please follow these steps:

1. Please retain your sales slip or invoice, as Vendor may require reasonable proof of your date of purchase.
2. Contact Vendor's Customer Service Department using the contact information listed below.
3. Return parts to Vendor, per Vendor's instructions, at your cost and expense.
4. Upon receipt by Vendor, Vendor shall advise you in writing whether a defect covered by this Limited Warranty exists in any returned part and whether your claim has been approved or denied.
5. Upon Vendor's approval of your claim, Vendor will replace such defective part without charge to you.

**WHAT THIS LIMITED WARRANTY DOES NOT COVER:** This Limited Warranty does not cover any failures or operating difficulties of the Product due to accident, abuse, misuse, alteration, misapplication, improper installation or improper maintenance or service by you or any third party, or failure to perform normal and routine maintenance on the Product, as set out in the User's Manual. In addition, this Limited Warranty does not cover damages to the finish, such as scratches, dents, discoloration or rust after purchase.

This Limited Warranty is the only express warranty given on the Product and is in lieu of all other express warranties. Vendor disclaims all warranties for products that are purchased from seller other than authorized retailers or distributors. THIS LIMITED WARRANTY RESTRICTS THE DURATION OF ANY AND ALL IMPLIED WARRANTIES, INCLUDING WITHOUT LIMITATION, THE IMPLIED WARRANTY OF MERCHANTABILITY AND FITNESS FOR A PARTICULAR PURPOSE TO THE ONE (1) YEAR TERM OF THIS LIMITED WARRANTY. UPON THE EXPIRATION OF THE ONE (1) YEAR TERM OF THIS LIMITED WARRANTY, VENDOR DISCLAIMS ANY AND ALL IMPLIED WARRANTIES, INCLUDING WITHOUT LIMITATION THE IMPLIED WARRANTIES OF MERCHANTABILITY AND FITNESS FOR A PARTICULAR PURPOSE, THE PRODUCT BEING THUS SOLD AS-IS, WITH ALL FAULTS. FURTHER, VENDOR SHALL HAVE NO LIABILITY WHATSOEVER TO PURCHASER OR ANY THIRD PARTY FOR ANY SPECIAL, INDIRECT, PUNITIVE, INCIDENTAL, OR CONSEQUENTIAL DAMAGES. OTHER THAN THIS LIMITED WARRANTY, THERE ARE NO WARRANTIES WHICH EXTEND BEYOND THE DESCRIPTION ON THE FACE HEREOF. Vendor assumes no responsibility for any defects caused by third parties. This Limited Warranty gives you specific legal rights, and you may have other rights which vary from state to state. State law may also override statements in this Limited Warranty regarding the restriction on the duration of implied warranties. Some jurisdictions do not allow exclusion or limitation of special, incidental or consequential damages, or limitations on how long a warranty lasts, so the above exclusion and limitations may not apply to you.



Contact Us

**Call:** +1 844-257-4103