

HANOVER[®]

Hanover Outdoor Furniture



IMPORTANT

If you have any problems with this product (missing or damaged parts, assembly issues, etc.),

PLEASE DO NOT RETURN TO THE RETAILER/STORE

from where you purchased the product.

Please call our Toll-Free Customer Service Hotline at: **1-800-416-3511**

Between 9:00 AM and 5:00 PM Eastern Time, Monday through Friday

Or visit our website at: **www.hanover-products.com**

To expedite any future warranty claims, please retain the Instruction Sheet, Warranty Card and receipt for future use.

For additional on-line support on assembly, troubleshooting and care & maintenance of your outdoor furniture, please visit our website at: **www.hanover-products.com**.

ASSEMBLY INSTRUCTIONS

1

Attach the seat frame to the back frame by using four 5/16"x40 mm bolts and washer as shown in *Figure 1*. Guide these bolts through the holes in the seat frame, into the fixed nuts already in place in the back frame. **Do not over tighten.**

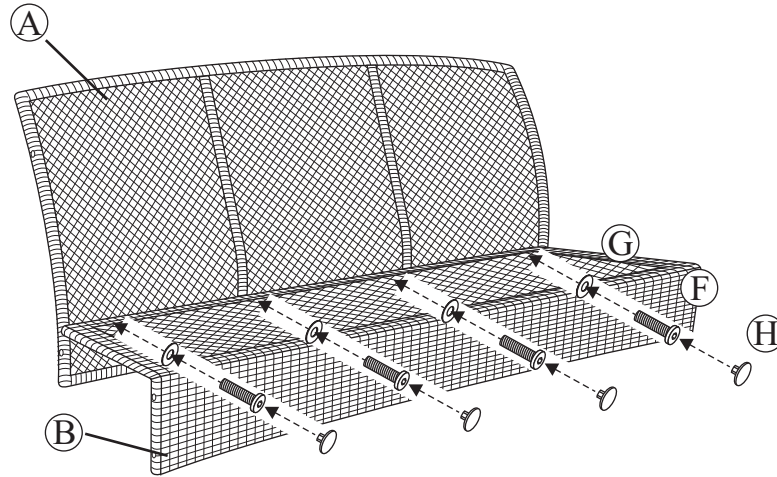

2

Attach love seat arm by inserting two 5/16"x25 mm bolts with washers through the holes in front seat portion of the love seat frame and into the holes in the love seat arm shown in *Figure 2*. Attach back of love seat arm by inserting two 5/16"x40 mm bolts with washers through holes in the back portion of love seat frame and into the holes in the rear portion of the love seat arm as shown in *Figure 2*. **Hand tighten only.** Repeat for the opposite side.

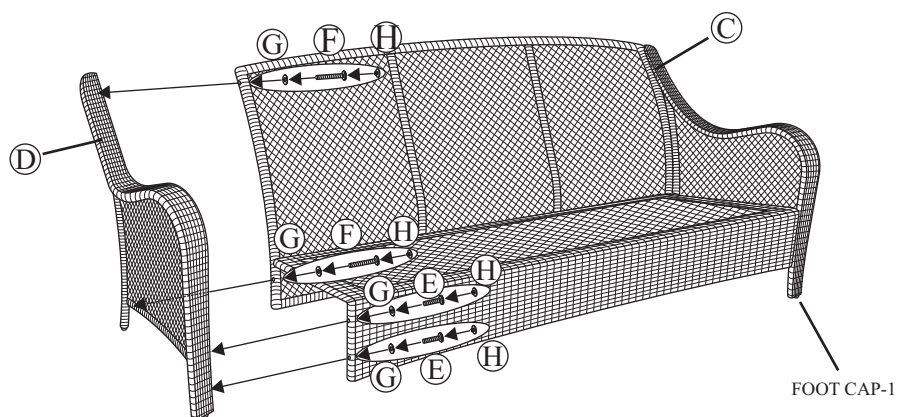







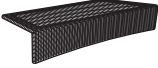
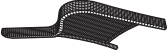

3

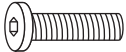
Tighten all bolts using the hex bolt driver provided. Tighten each bolt a few revolutions at a time, alternating between bolt connections until all bolts are tight. **Do not over tighten. Over tightening may strip bolts or damage the welds or frame.** Cover all bolts with bolt covers provided.

PARTS IDENTIFICATION LIST

** NOTE: PARTS SHOWN ON PARTS LIST ARE NOT TO SCALE*

	<u>PARTS LIST</u>	<u>DESCRIPTION</u>	<u>ORDER PART #</u>	<u>QTY</u>
A		BACK FRAME	SK0939	1
B		SEAT FRAME	SK0940	1
C		LEFT ARM	SK0941	1
D		RIGHT ARM	SK0942	1
E		5/16" X 25 MM BOLT	HW0186	4
F		5/16" X 40 MM BOLT	HW0275	8
G		Ø8.5 X 1.5 MM WASHER	HW0005	12
H		BOLT COVER	HW0022	12
I		HEX BOLT DRIVER	HW0006	1
		FOOT CAP-1 <i>FACTORY ASSEMBLY</i>	FC0030	
		FOOT CAP-2 <i>FACTORY ASSEMBLY</i>	FC0308	

BGC08006

ASSEMBLY INSTRUCTIONS

- 1 Assemble furniture on a smooth, non-abrasive surface. Attach the back frame to right arm by using two 5/16"x40 mm bolts and washers as shown in **Fig.1**. Guide the bolts through holes in back frame, into pre-drilled holes in the right arm. **Hand tighten only**. Attach the seat frame to right arm and back frame by using four 5/16"x25 mm bolts and washers as shown in **Fig.2**. **Hand tighten only**. Attach the left arm to back and seat frame by using two 5/16"x25 mm bolts and two 5/16"x40 mm bolts and four washers as shown in **Fig.3**. **Hand tighten only**.

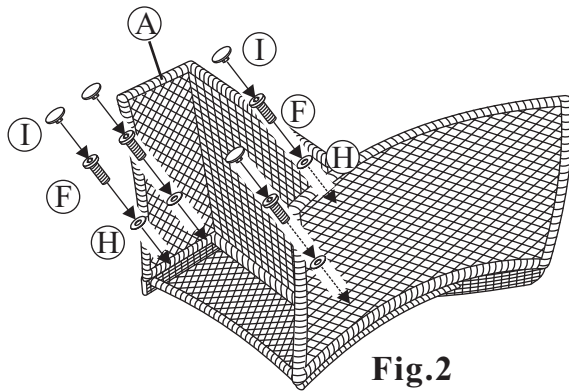
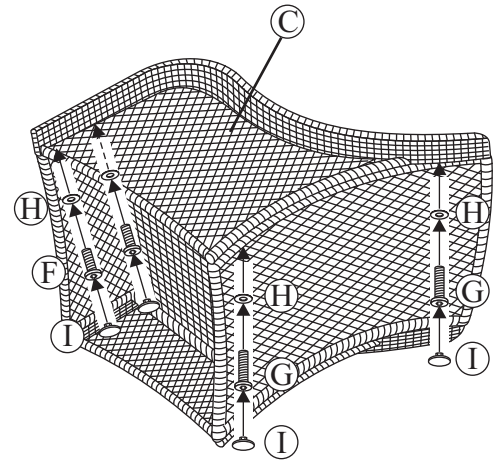
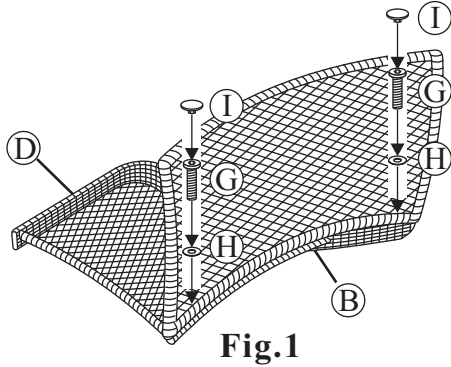

Fig.3

Fig.2

- 2 Attach the complete base to the complete seat by using four 5/16"x40 mm bolts and washers as shown in **Fig.4**. Guide the bolts through holes in base, into the pre-drilled holes in the seat. **Hand tighten only**.

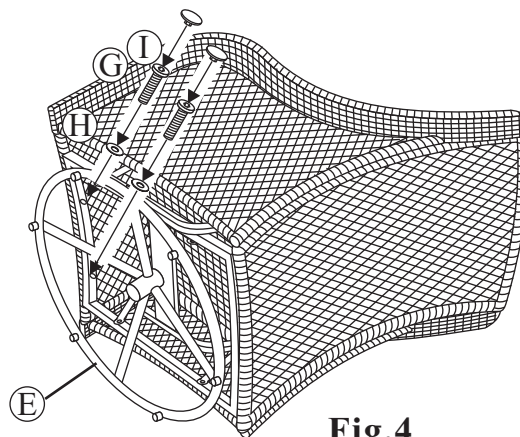

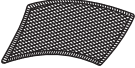

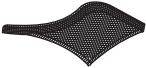

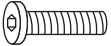



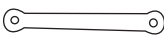
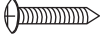



Fig.4

- 3 Using the hex bolt driver provided, tighten all bolts. **Do not over tighten bolts. If nuts and bolts are too tight or too loose, the glider will not function properly.** Test the operation of glider. Gliding motion should be smooth. Adjust tension on the glider brackets, nuts and bolts as needed. Cover nuts and bolts with covers provided.

PARTS IDENTIFICATION LIST

* NOTE: PARTS SHOWN ON PARTS LIST ARE NOT TO SCALE

	<u>PARTS LIST</u>	<u>DESCRIPTION</u>	<u>ORDER PART #</u>	<u>QTY</u>
A		SEAT FRAME	SG0154	1
B		BACK FRAME	SG0155	1
C		LEFT ARM	SG0156	1
D		RIGHT ARM	SG0157	1
E		GLIDER BASE W/ GLIDER BRACKET	SG0158 SG0159	1
F		5/16" X 25 MM BOLT	HW0186	6
G		5/16" X 40 MM BOLT	HW0275	8
H		Ø8.5 X 1.5 MM WASHER	HW0005	14
I		BOLT COVER	HW0105	14
J		HEX BOLT DRIVER	HW0006	1
		GLIDER BRACKET <i>FACTORY ASSEMBLY</i>	G0080	
		ST4.8 X 25 BOLT <i>FACTORY ASSEMBLY</i>	HW0695	
		FOOT CAP <i>FACTORY ASSEMBLY</i>	FC0013	

BGS12023

ASSEMBLY INSTRUCTIONS

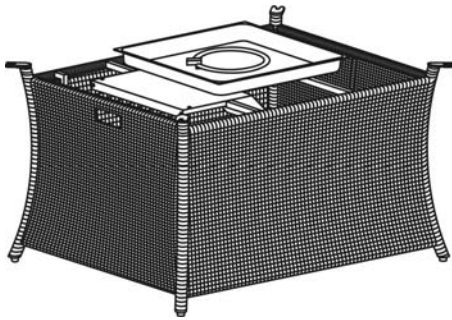

CSA Model 98910



ARL11103

Installer: Leave these instructions with consumer.

Consumer: Keep these instructions for future reference.



DANGER

If you smell gas:

1. Shut off gas to the appliance.
2. Extinguish any open flame.
3. If odor continues, keep away from the appliance and immediately call your gas supplier or fire department.



WARNING:

Improper installation, adjustment alteration, service or maintenance can cause injury or property damage. Read the installation, operating and maintenance instructions thoroughly before installing or servicing this equipment.



WARNING

Do not store or use gasoline or other flammable vapors and liquids in the vicinity of this or any other appliance. An LP-cylinder not connected for use shall not be stored in the vicinity of this or any other appliance.



WARNING: For Outdoor Use Only

FOR USE WITH 20LB (9KG) PROPANE CYLINDER WITH TYPE 1 CONNECTION OR FOR USE WITH NATURAL GAS AFTER CONVERSION KIT IS INSTALLED (MUST BE PROFESSIONALLY INSTALLED).



DANGER

CARBON MONOXIDE HAZARD



This appliance can produce carbon monoxide which has no odor.

Using it in an enclosed space can kill you.

Never use this appliance in an enclosed space such as a camper, tent, car or home.

WARNING:

USE FACTORY APPROVED REPLACEMENT PARTS AND ACCESSORIES ONLY. USE OF UNAPPROVED PART OR ACCESSORIES CAN VOID THE WARRANTY ON THIS PRODUCT AND RESULT IN A HAZARDOUS CONDITION. PLEASE CONTACT US FOR INFORMATION REGARDING REPLACEMENT HOSES, THERMOCOUPLES, ELECTRODES, IGNITION MODULES, LAVAROCKS, LOGS, FIRE ICE, ETC.



Questions, Problems, Missing Parts? Before returning to your retailer, call our customer service department in the US and Canada at 1-800-416-3511, Monday-Friday, 9 a.m. – 5 p.m. Eastern Time.

IMPORTANT SAFETY INFORMATION

The installation must conform with local codes or, in the absence of local codes, with the National Fuel Gas Code, ANSI Z223.1/NFPA 54; International Fuel Gas Code. ; Natural Gas and Propane Installation Code, CSA B149.1; or Propane Storage and Handling Code, B149.2, as applicable.

The appliance and its appliance main gas valve must be disconnected from the gas supply piping system during any pressure testing of that system at test pressures in excess of 1/2 psi (3.5kPa).

The appliance must be isolated from the gas supply piping system by closing its equipment shutoff valve during any pressure testing of the gas supply system at test pressure equal to or less than 1/2 psi (3.5kPa).

The appliance area must be kept clear and free from combustible materials, gasoline and other flammable vapors and liquids.

Do not use this appliance if any part has been under water. Immediately call a qualified service technician to inspect the appliance and to replace any part of the control system and any gas control which has been under water.

Children and adults should be alerted to the hazards of high surface temperatures and kept at a safe distance to avoid burns or clothing ignition.

Young children should be carefully supervised when they are anywhere near the appliance.

Clothing or other flammable material should not be hung from the appliance, or placed on or near the appliance.

Any screen or guard removed for servicing an appliance must be replaced prior to operating the appliance.

Installation and repair should be done by a qualified service person. The appliance should be inspected before use and at least annually by a professional service person. More frequent cleaning may be required as necessary. It is imperative that the control compartments, burners and circulating air passageways of the appliance be kept clean.

Do NOT burn solid fuels in this gas fireplace.

Do NOT ignite the burner before pouring all of the burner media (lava rock or fire glass) into the burner pan. The media must be evenly distributed over the burner.

CAUTION: The propane gas pressure regulator provided with this appliance must be used. This regulator is set for an outlet pressure of 11 inches water column.

This outdoor gas appliance is not intended to be installed in or on recreational vehicles and/or boats.

Before each use of this gas appliance, open the LP (Liquid Propane) Tank Drawer and inspect the LP Hose. If there is evidence of excessive abrasion or wear, or the hose is cut, it must be replaced prior to the gas appliance being put into operation. Use only the replacement hose assembly specified in this manual. Inspect the burner before each use of the appliance. The burner must be replaced prior to the appliance being put into operation if it is evident that the burner is damaged. Use only the burner listed in these instructions.

Keep the fuel supply hose away from any heated surfaces.

IMPORTANT SAFETY INFORMATION ABOUT PROPANE (LP) GAS

A self contained LP-gas cylinder for use with this appliance must have a capacity of 20 lbs. and must be equipped with a Type 1 connector and an OPD (overfill protection device). See Figure 1.

The LP-gas supply cylinder to be used must be constructed and marked in accordance with the specification for LP-gas cylinders of the U.S. Department of Transportation (DOT) or the National Standard of Canada, *CAN/CSA-B339, Cylinder, Sphere and Tubes for the Transportation of Dangerous Goods.*

- The cylinder supply system must be arranged for vapor withdrawal.
- The cylinder used must include a collar to protect the cylinder valve.
- This appliance shall be used only outdoors in a well-ventilated space and shall not be used in a building, garage or any other enclosed space.
- When this appliance is not in use, the gas must be turned off at the supply cylinder.
- Storage of this appliance indoors is permissible only if the cylinder is disconnected and removed from the appliance.
- Cylinders must be stored outdoors in a well-ventilated area out of the reach of children. Disconnected cylinders must have threaded valve plugs tightly installed and must not be stored in a building, garage or any other enclosed areas.

CSA (Canadian Standards Association) certified to ANSI Z21.97•CSA 2.41-2015 “ Outdoor Decorative Gas Appliances” The gas hose is routed through a “U” bolt to prevent the hose from coming in contact with the burner. DO NOT remove the hose from the “U” bolt. See Figure 2.

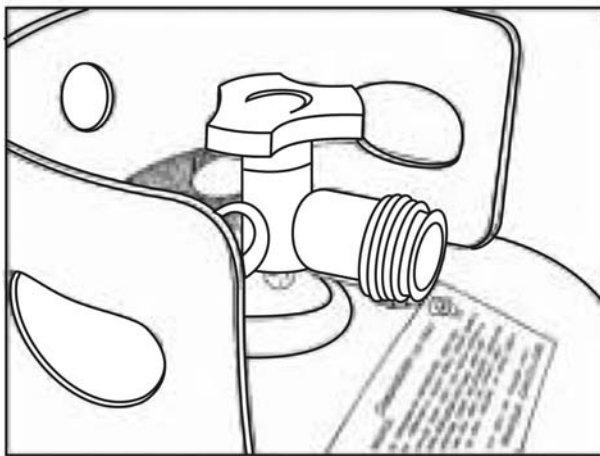

Figure 1

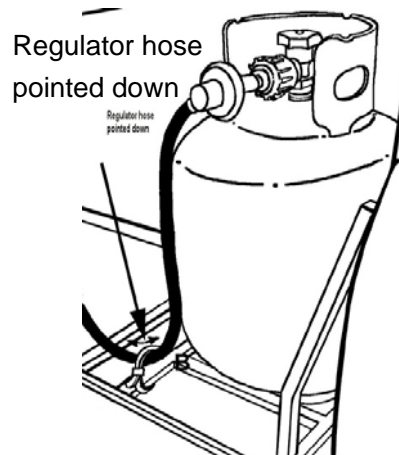

















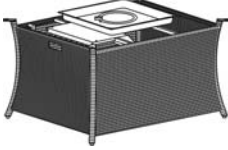



Figure 2

SPECIFICATIONS

INPUT	40,000 Btu/hr	30,000 Btu/hr Low fire
Propane Regulator Pressure	11 inches water column	
Natural Gas Minimum Inlet Pressure	7 inches water column	
Clearances to combustible surfaces	Sides 24in./61cm	Top: 72 in. / 183 cm

PARTS IDENTIFICATION LIST

	PART	DESCRIPTION	PART#	QTY
A		CONTROL KNOB	FP0245	1
B		GAS VALVE	FP0307	1
C		THERMOCOUPLE	FP0004	1
D		LP REGULATOR HOSE	FP1369	1
E		ELECTRODE	FP1375	1
F		GAS TUBE	FP0309	1
G		ORIFICE ELBOW	FP1385	1
H		IGNITION MODULE	FP0006	1
I		ORIFICE BRACKET	FP0311	1
J		PROPANE ORIFICE	FP1283	1
K		NATURAL GAS ORIFICE	FP1284	1
L		LP TANK RETAINING KNOB	FP0585	2
M		"AAA" BATTERY(1.5V)	HW0705	1
N		ADJUSTABLE FOOT CAPS	FC0553	4
O		BOLTS	HW0036	4
P		WASHERS	HW0103	4
Q		HEX BOLT DRIVER	HW0006	1
R		FIREPIT BASE	FP1532	1
T		FIREPAN/BURNER ASSEMBLY	FP1533	1
V		FIRE ICE SET	ZCF0092	1

INSTALLATION

1. With the help of another person, turn the table base assembly in the upright position. Carefully place the table top (not included) onto the table base. After making any necessary adjustments to the alignment of the table top and firepit base, use bolts and washers as shown in Figure 3. Guide the bolts through the holes in the base brackets, into the pre-drilled holes in the table top. Do not tighten completely. Repeat on other three sides. (Note: holes do not go through to the top of the table. Holes shown for illustration purposes only.)

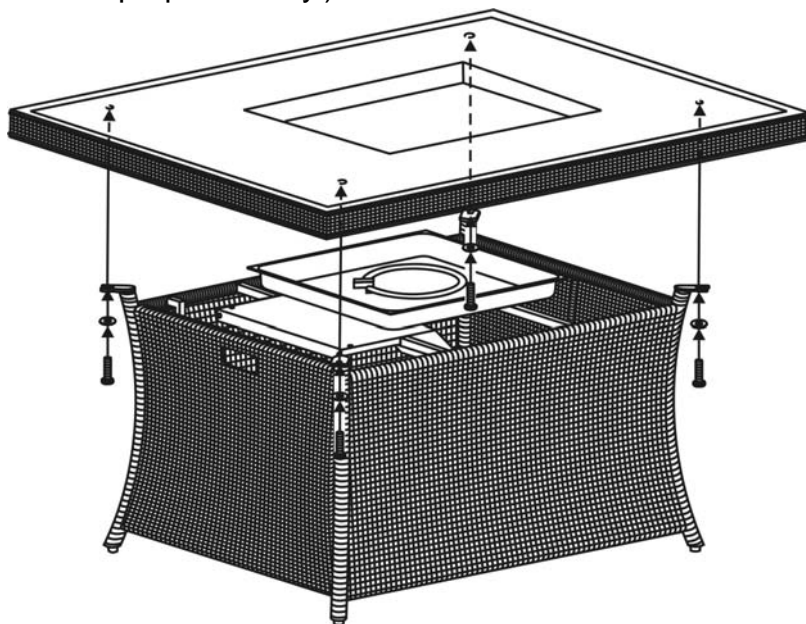

Figure 3

2. Pour all of the fire ices into the burner pan. Completely cover the burner tube with fire ices as shown in Figure 4.

Burner Pan

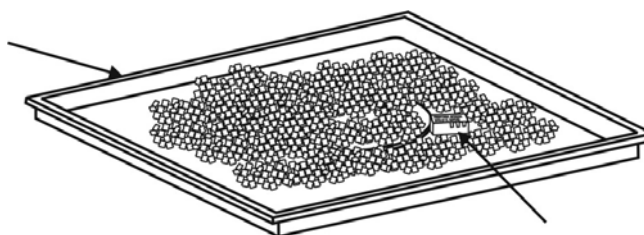

Figure 4

Ignition Well

3. Remove the cardboard cover from the ignition well as shown in Figure 5. Remove any lava rock or fire ice on top of ignition well.

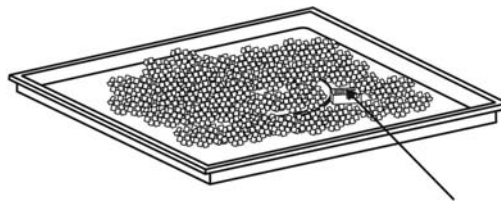

Figure 5

Cardboard Cover

4. Lift off the tank door, place the tank in the holder and use the chain to hold the tank. Connect the regulator as shown in Figure 6. Turn the black handle clock-wise to tighten. Turn the handle counterclock-wise to remove. The hose must point down. Open the control door and check that the valve is turned all the way clockwise to the “OFF” position. Open the tank valve. Apply a solution of soapy water to the tank-regulator connection and to the valve-hose connection to check for leaks. If soap bubbles continue to form, the connection has a leak. If a leak is found, close the tank valve and tighten all connections. **NEVER USE A FLAME TO CHECK FOR LEAKS.**

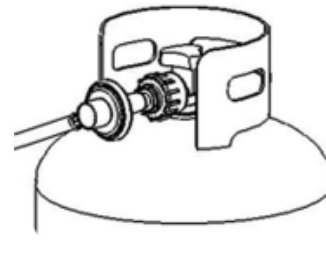
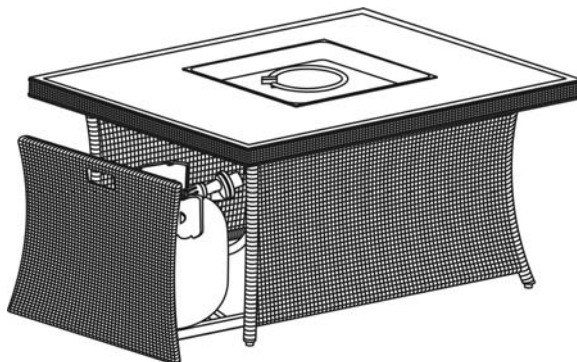

Figure 6

5. Tighten threaded knobs found on tank tray (Figure 7) so that the LP tank cannot move from side to side. Do not remove plastic cap from end of threaded section.

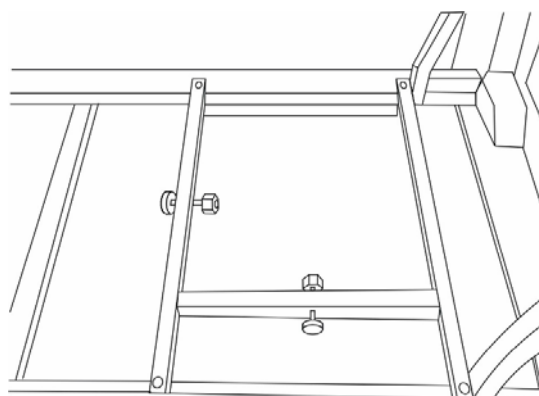

Figure 7



NATURAL GAS CONVERSION



Natural gas conversion must be performed only by your natural gas provider or service company.

1. Disconnect the regulator hose from the gas valve. See Figure 8.

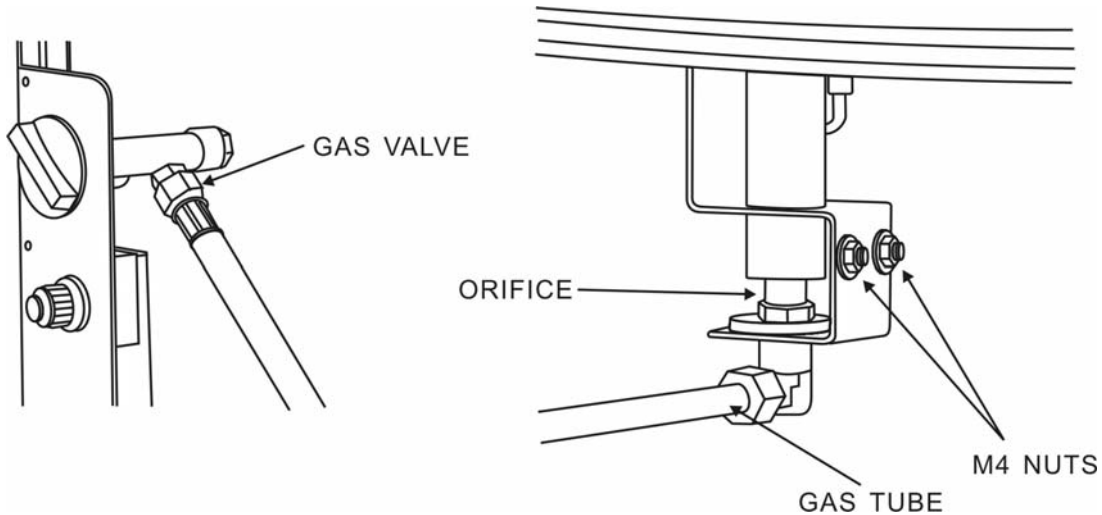

Figure 8

2. Disconnect the gas tube from the orifice elbow. Remove the two M4 nuts and remove the orifice holder. Replace the propane orifice with the natural gas orifice from the kit and reinstall the orifice holder. Apply a solution of soapy water to all connections to check for leaks. If soap bubbles continue to form, the connection has a leak. If a leak is found, close the main valve and tighten all connections. **NEVER USE A FLAME TO CHECK FOR LEAKS.**

3. Stick the conversion label on the rating plate as shown in Figure 9.

Metal Rating Plate

Serial Number _____	Model Number: 98910
CAUTION: The gas pressure regulator provided with this appliance must be used. This regulator is set for an outlet pressure of	
This appliance has been converted to use Natural Gas. Input 40,000 Btu/hr. Max Gas Supply Pressure 7 inch w.c. (1.74 kPa) Min. Gas Supply Pressure 5 inch w.c. (1.24 kPa)	
Minimum clearance from combustible constructions: Sides: 24 in. 609 mm. Top 72 in. 1828 mm. FOR OUTDOOR USE ONLY. If stored indoors, detach and leave cylinder outdoors.	
⚠ WARNING: Improper installation, adjustment alteration, service or maintenance can cause injury or property damage. Refer to the owner's information manual provided with this appliance. For assistance, or additional information, consult a qualified installer, service agency, or the gas supplier.	

Figure 9

Conversion Label

LIGHTING INSTRUCTIONS

1. Locate the control and igniter panel. Make sure the control knob is in the "OFF" position. See Figure 10. Open the tank door and open the tank valve all the way.
2. Push in the igniter button. You will hear a slight clicking sound. With the igniter button pushed in, push and turn the control knob to the "ON" position. The fire should light within a few seconds. Once the flame is lit, release the igniter button and continue to hold the control knob in for 10 to 15 seconds. Release the control knob. The control knob should pop back out and the fire should remain lit. Note: If the fire does not light, turn the knob to the "OFF" position and wait five (5) minutes before trying again.
3. To turn down the flame, push the control knob in slightly and turn to the Medium (medium flame) or Low (small flame).
4. To shut down the fire pit, turn the control knob to the "OFF" position and turn off the tank valve

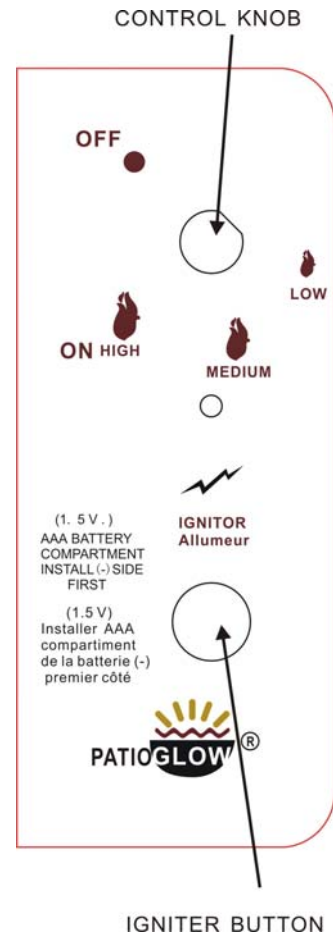

Figure 10

MAINTENANCE

The flames should look like those in Figure 11. To clean the burner, use a soft brush after the burner and lava rocks have cooled completely. Never use a vacuum cleaner on the lava rocks. It is recommended that the lava rocks be stored indoors during the winter if they will be subjected to freezing temperatures. The propane cylinder must be disconnected and removed from the appliance before the appliance can be stored indoors.



Figure 11

BATTERIES

Make sure the control knob is in the "OFF" position. Unscrew the push button cap on the ignition module located on the control panel to access the battery compartment. The ignition module requires one AAA size battery. See Figure 12.

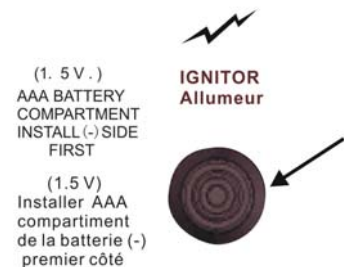

Figure 12

TROUBLESHOOTING GUIDE

PROBLEM	CAUSE	REMEDY
Burner won't light	No Propane Gas at Burner	Check that gas tank valve is open. Turn control knob to "ON" and push control knob in. Make sure tank has propane gas.
	No Spark at Electrode	Check that AAA battery is installed with negative (-) end first and has a charge. Check that the wire is connected to the ignition module. Check that the electrode is not cracked or broken.
	Lack of oxygen	Remove excess lava rocks or fire ices from around the ignition well.
Burner won't stay lit after lighting	Thermocouple not in flame	Check that the tip of the thermocouple is even with the top of the ignition well. Remove any fire ices from the igtion well.
	Thermocouple connection at the main control valve is loose	Tighten the thermocouple nut at the back of the valve.
	No Fire ice on Burner	Cover the burner with fire ices per the instructions