

Wave 5 Rack

Made in **USA**★

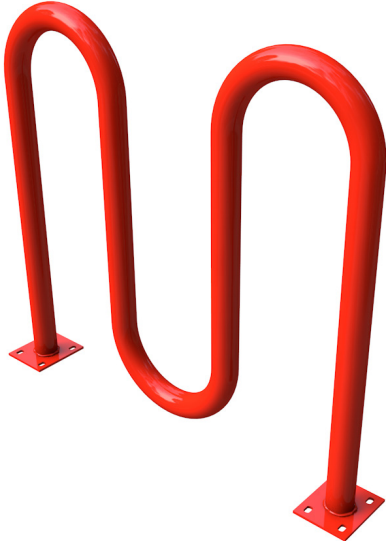

- U-lock compatible
- Parks 5 bicycles
- Easy installation
- 97% Recycled content

Material	2" Sched. 10 Steel Pipe
Height	36"
Width	38"
Weight	40 lbs

MOUNT OPTIONS

Surface

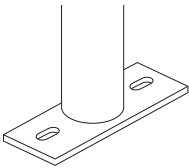

In-Ground

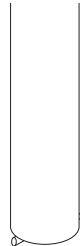

FINISH OPTIONS

Galvanized

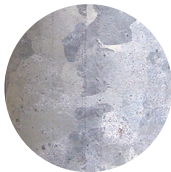

Powder Coat

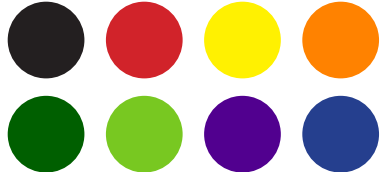

Wave 5 Rack

Installation

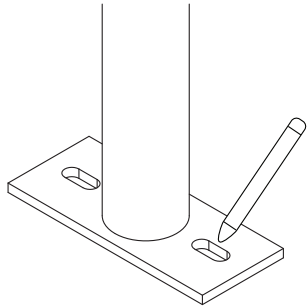

1. Place the rack in the desired location. Use a marker or pencil to outline the holes of the flange onto the base material.

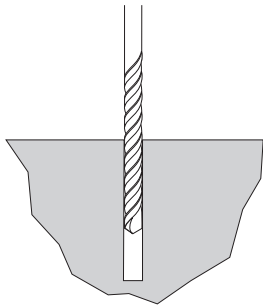

2. Drill 3/8" diameter holes 3" deep into surface. Make sure the holes are at least 3" away from any cracks in the base material.

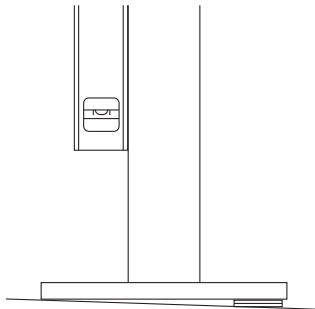

3. Place rack (and washers to level rack if necessary) over holes.

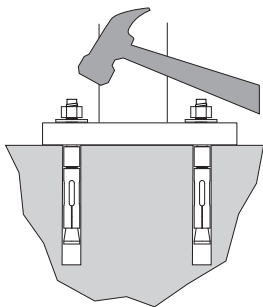

4. Thread nuts onto anchors, leaving approximately 1/4" of the anchor protruding, and tap into surface. Tighten nuts down to secure rack.

Wave 5 Rack

In-Ground Installation

Tools Needed

Level

Cement mixing tub

Shovel

Trowel

Hole coring machine with 4" bit

Access to water hose

Installing into existing concrete

Core holes no less than 3" diameter (4" recommended) and 10" deep into sidewalk. Fill holes with Por-Rok or epoxy grout. Place rack into holes, making sure the rack is level. 33"-36" of the rack should remain above the surface. If the rack is less than 33" high, it will not support the bike adequately. Make sure the rack is level and held in place until the grout has set.

Installing into new concrete

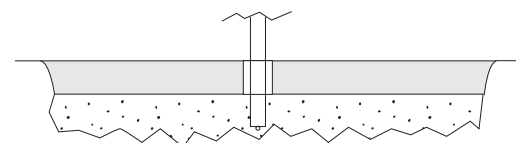
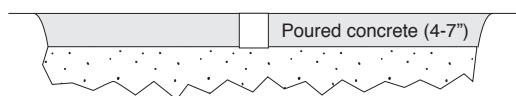
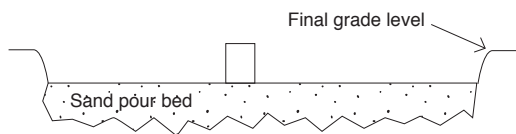

1. Place corrosion resistant sleeve (min. 3" inside diameter) in sand pour bed in exact location where rack will be installed. Make sure top of sleeve is at same level as desired finished concrete surface. Fill sleeve with sand to keep it in place and prevent it from filling with concrete.

2. Pour concrete and allow to cure

3. After appropriate cure time, dig out sand from sleeves and insert racks, making sure they are level and at the appropriate height. Pour in Por-Rok or epoxy grout and allow to set.