

INSTALLATION

Installation Overview

Please read the following installation instructions first after purchasing this product or transporting it to another location.

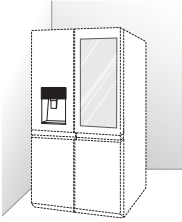

1 Unpacking your refrigerator

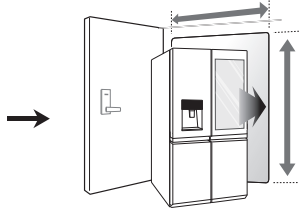

2 Choosing the proper location

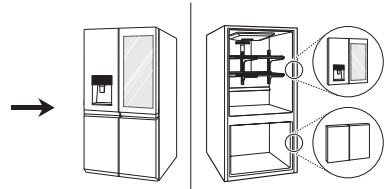

3 Disassembling/Assembling

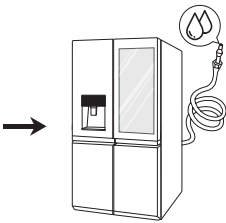

4 Connecting the water supply and water line

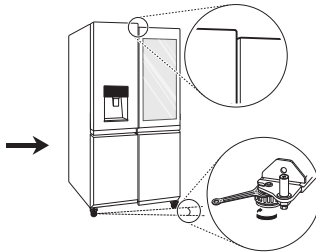

5 Leveling and Door Alignment

NOTE

Connect to potable water supply only.

Specifications

The appearance and specifications listed in this manual may vary due to constant product improvements.

Bottom-freezer refrigerator model LUPXS3186N	
Description	French-door refrigerator
Electrical requirements	115 VAC @ 60 Hz
Min./Max. Water pressure	20 - 120psi (138 - 827kPa)
Dimensions	35 7/8" (W) x 36 1/2" (D) x 70 1/4" (H) x 51 1/8" (D w/ door open) 912(W) X 929(D) X 1784(H) X 1298 mm (D w/ door open)
Net weight	483 lb. (219 kg)

Bottom-freezer refrigerator model LUPXC2386N	
Description	French-door refrigerator
Electrical requirements	115 VAC @ 60 Hz
Min./Max. Water pressure	20 - 120psi (138 - 827kPa)
Dimensions	35 7/8" (W) x 29 5/8" (D) x 70 1/4" (H) x 44 3/16" (D w/ door open) 912(W) X 754(D) X 1784(H) X 1123 mm (D w/ door open)
Net weight	430 lb. (195 kg)

Unpacking the Refrigerator

WARNING

- Use two or more people to move and install the refrigerator. Failure to do so can result in back or other injury.
- Your refrigerator is heavy. When moving the refrigerator for cleaning or service, be sure to protect the floor. Always pull the refrigerator straight out when moving it. Do not wiggle or walk the refrigerator when trying to move it, as floor damage could occur.
- Keep flammable materials and vapors, such as gasoline, away from the refrigerator. Failure to do so can result in fire, explosion, or death.

Remove tape and any temporary labels from your refrigerator before using. Do not remove any warning-type labels, the model and serial number label, or the Tech Sheet that is located under the front of the refrigerator.

But, when you remove tape and temporary label, remove them after pulling out the power plug.

To remove any remaining tape or glue, rub the area briskly with your thumb. Tape or glue residue can also be easily removed by rubbing a small amount of liquid dish soap over the adhesive with your fingers. Wipe with warm water and dry.

Do not use sharp instruments, rubbing alcohol, flammable fluids, or abrasive cleaners to remove tape or glue. These products can damage the surface of your refrigerator.

Refrigerator shelves are installed in the shipping position. Please reinstall shelves according to your individual storage needs.

Choosing the Proper Location

- Select a place where a water supply can be easily connected for the automatic icemaker.

NOTE

The water pressure must be 20~120 psi or 138~827 kPa or 1.4~8.4 kgf/cm² on models without a water filter and 40~120 psi or 276~827 kPa or 2.8~8.4 kgf/cm² on models with a water filter.

- The refrigerator should always be plugged into its own individual properly grounded electrical outlet rated for 115 Volts, 60 Hz, AC only, and fused at 15 or 20 amperes. This provides the best performance and also prevents overloading house wiring circuits which could cause a fire hazard from overheated wires. It is recommended that a separate circuit serving only this appliance be provided.

WARNING

To reduce the risk of electric shock, do not install the refrigerator in a wet or damp area.

Flooring

To avoid noise and vibration, the unit must be leveled and installed on a solidly constructed floor. If required, adjust the leveling legs to compensate for unevenness of the floor. The front should be slightly higher than the rear to aid in door closing. Leveling legs can be turned easily by tipping the cabinet slightly. Turn the leveling legs to the left to raise the unit or to the right to lower it. (See Leveling and Door Allignment.)

NOTE

Installing on carpeting, soft tile surfaces, a platform or weakly supported structure is not recommended.

Ambient Temperature

Install this appliance in an area where the temperature is between 55°F (13°C) and 110°F (43°C). If the temperature around the appliance is too low or high, cooling ability may be adversely affected.

Measuring the Clearances

Too small of a distance from adjacent items may result in lowered freezing capability and increased electricity consumption charges. Allow at least 24 inches (61 cm) in front of the refrigerator to open the doors, and at least 2 inches (5.08 cm) between the back of the refrigerator and the wall.

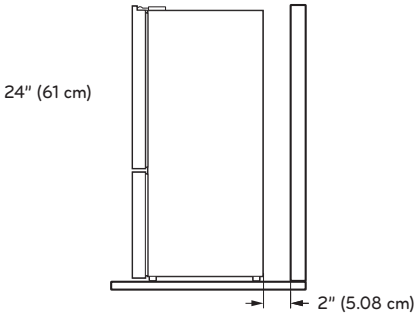

Removing/Assembling the Doors

Removing the Left Refrigerator Door

- 1 The water supply is connected to the upper right part of the rear surface of the refrigerator. Remove the ring in the joint area. Hold the water supply connection and gently push the collet to detach the water supply line as shown in **1**.

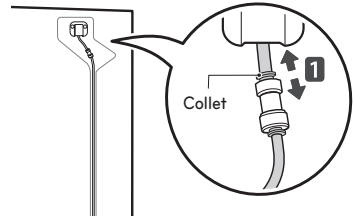

NOTE

Detachment of the water supply line is applicable only when detaching the left refrigerator door.

- 2 Remove the screws from the hinge cover at the top of the refrigerator. Lift the hook(not visible), located on the side of the cover at the bottom edge, with a flat-head screwdriver.

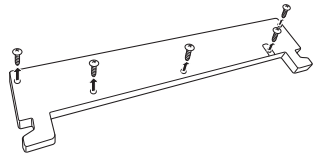

- 3 Remove the cover and pull out the tube **1**. Disconnect all wire harnesses **2**.

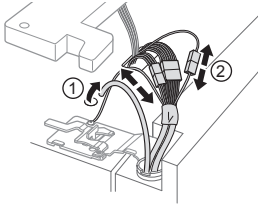

- 4 Rotate the hinge lever counterclockwise **1**. Lift the top hinge **2** free of the hinge lever latch.

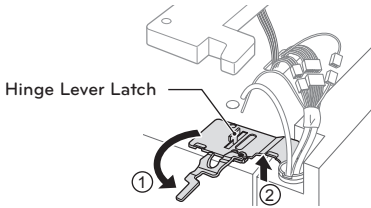

CAUTION

When lifting the hinge free of the latch, be careful that the door does not fall forward.

- 5 Lift the door from the middle hinge pin and remove the door.

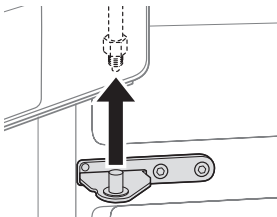

CAUTION

Place the door, inside facing up, on a non-scratching surface.

Removing the Right Refrigerator Door

- 1 Remove the screws from the hinge cover at the top of the refrigerator. Lift the hook(not visible), located on the side of the cover at the bottom edge, with a flat-head screwdriver.

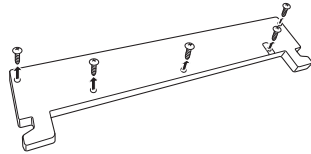

- 2 Detach the wire harness **1**.

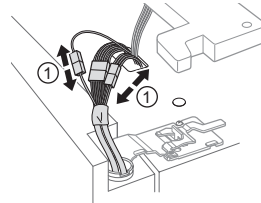

- 3 Rotate the hinge lever **1** clockwise. Lift the top hinge **2** free of the hinge lever latch.

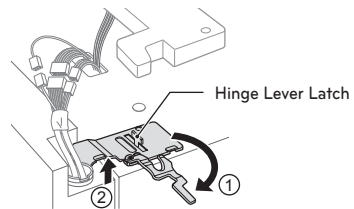

CAUTION

When lifting the hinge free of the hinge lever latch, be careful that the door does not fall forward.

- 4 Lift the door from the middle hinge pin and remove the door.

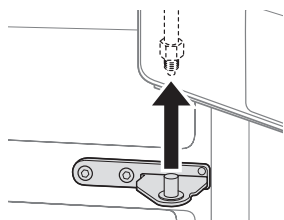

CAUTION

Place the door, inside facing up, on a non-scratching surface.

Removing the Freezer Doors

- 1 Remove the two hinge bolts.

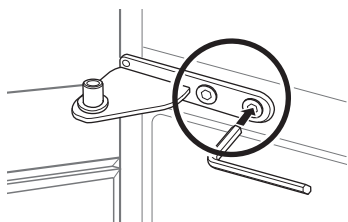

- 2 Twist the hinge to raise the pivoting end so that the door can be lifted off. Lift the door off the lower hinge pin and remove it.

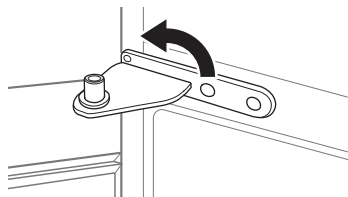

- 3 Unscrew the screw that attaches the lower hinge cover and remove the cover.

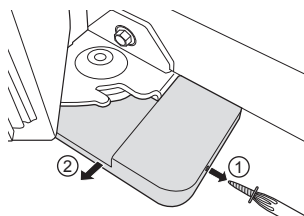

- 4 Disconnect all wire harnesses.

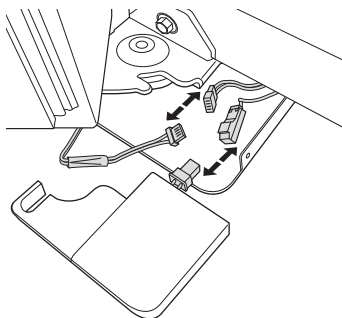

- 5 Remove the door by lifting it off the lower hinge pin.

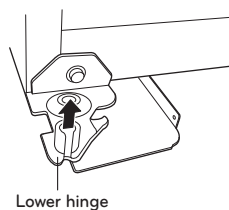

Assembling the Freezer Doors

- 1 Lower the door onto the lower hinge pin.

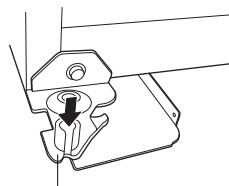

- 2 Connect the wire harnesses.

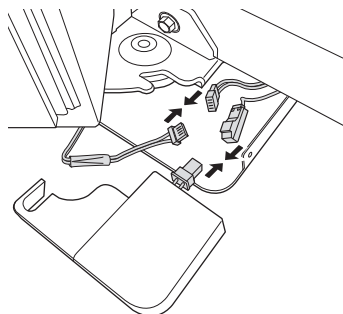

- 3 Position the bottom hinge cover in its place **1** and tighten the cover screw **2**.

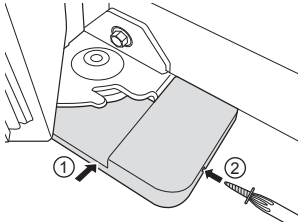

- 4 Position the middle hinge pin in place to hold the door and insert the two hinge bolts.

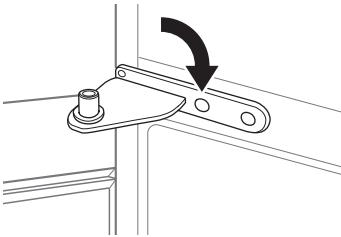

- 5 Tighten the two hinge bolts.

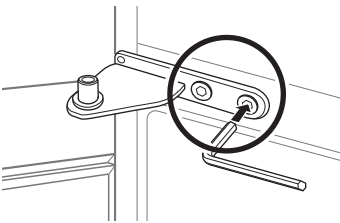

Assembling the Right Refrigerator Door

Install the right refrigerator door first.

- 1 Make sure that the plastic sleeve is inserted in the bottom of the door. Lower the door onto the middle hinge pin as shown in the figure.

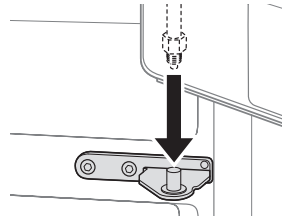

- 2 Fit the hinge **1** over the hinge lever latch and slot it into place. Rotate the lever **2** counterclockwise to secure the hinge.

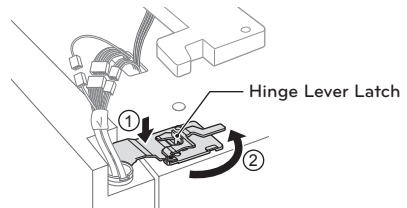

- 3 Connect the wire harness **1**.

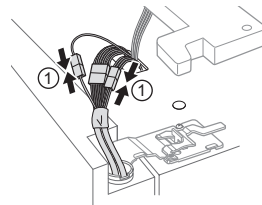

- 4 Position the cover in its place. Insert and tighten the cover screws.

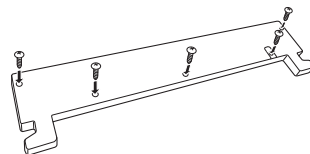

Assembling the Left Refrigerator Door

Install the left refrigerator door after the right door is installed.

- 1 Make sure that the plastic sleeve is inserted in the bottom of the door. Install the refrigerator door onto the middle hinge pin.

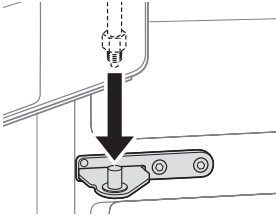

- 2 Fit the hinge **1** over the hinge lever latch and slot it into place. Rotate the lever clockwise **2** and fasten the hinge.

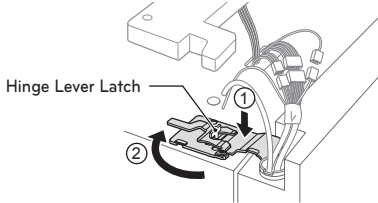

- 3 Connect all the wire harnesses.

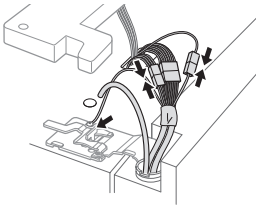

- 4 Push the water supply tube into the hole on the top case and pull it through the backplate.

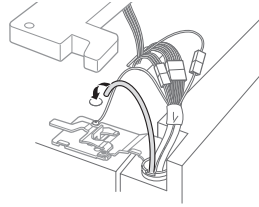

- 5 Hold the water supply connection and gently push in the collet to connect the water supply line as shown in **1**. Insert the tube at least $\frac{5}{8}$ inch (15 mm) into the connector.

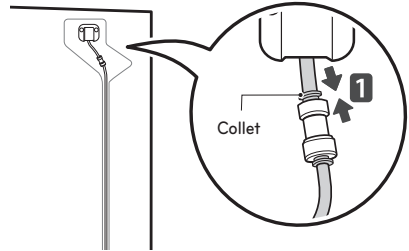

- 6 Position the cover in its place. Insert and tighten the cover screws.

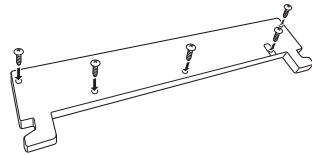

NOTE

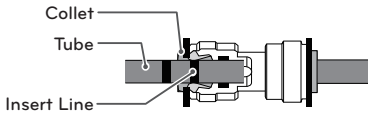

- 1) Gently insert the tube until only one line shows on the tube.

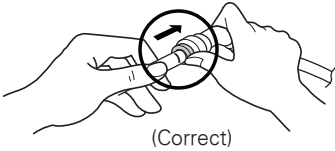

(Correct)

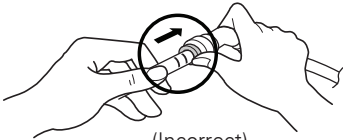

(Incorrect)

- 2) Pull the tube to make sure that the tube is tightly fastened.

Connecting the Water Line

Before You Begin

This water line installation is not covered by the refrigerator warranty. Follow these instructions carefully to minimize the risk of expensive water damage.

Water hammer (water banging in the pipes) in house plumbing can cause damage to refrigerator parts and can lead to water leakage or flooding. Call a qualified plumber to correct water hammer before installing the water supply line to the refrigerator.

CAUTION

To prevent burns and product damage, only connect the refrigerator water line to a cold water supply.

If you use your refrigerator before connecting the water line, make sure the icemaker power switch on the control panel is in the OFF position.

CAUTION

Do not install the icemaker tubing in areas where temperatures fall below freezing.

Water Pressure

The water pressure must be 20~120 psi or 138~827 kPa or 1.4~8.4 kgf/cm² on models without a water filter and 40~120 psi or 276~827 kPa or 2.8~8.4 kgf/cm² on models with a water filter.

If a reverse osmosis water filtration system is connected to the cold water supply, this water line installation is not covered by the refrigerator warranty. Follow the instructions carefully to minimize the risk of expensive water damage.

If a reverse osmosis water filtration system is connected to the cold water supply, the water pressure to the reverse osmosis system needs to be a minimum of 40 to 60 psi (276~414 kPa or 2.8~4.2 kgf/cm², less than 2.0~3.0 sec. to fill a cup of 7 oz or 198 cc capacity).



CAUTION

Wear eye protection during installation to prevent injury.

If the water pressure from the reverse osmosis system is less than 20 psi or 138 kPa or 1.4 kgf/cm² (takes more than 4.0 sec to fill a cup of 7 oz or 198 cc capacity):

- Check to see if the sediment filter in the reverse osmosis system is blocked. Replace the filter if necessary.
- Allow the storage tank on the reverse osmosis system to refill after heavy usage.
- If the issue concerning water pressure from reverse osmosis remains, call a licensed, qualified plumber.
- All installations must be in accordance with local plumbing code requirements.

What You Will Need

- **Copper Tubing**, ¼ in. outer diameter, to connect the refrigerator to the water supply. Be sure both ends of the tubing are cut square.
- To determine how much tubing you need: measure the distance from the water valve on the back of the refrigerator to the water supply pipe. Then, add 8 feet (2.4 m). Be sure there is sufficient extra tubing (about 8 feet [2.4 m] coiled into 3 turns of about 10 in. [25 cm] diameter) to allow the refrigerator to move out from the wall after installation.

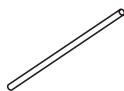

- **Power drill.**
- **½ in. or adjustable wrench.**
- **Flat blade and Phillips head screwdrivers.**
- **Two ¼ in. outer diameter compression nuts and 2 ferrules (sleeves)** to connect the copper tubing to the shutoff valve and the refrigerator water valve.

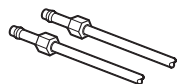
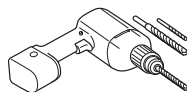

- If your existing copper water line has a flared fitting at the end, you will need an adapter (available at plumbing supply stores) to connect the water line to the refrigerator OR you can cut off the flared fitting with a tube cutter and then use a compression fitting.

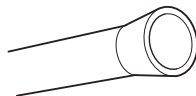

- **Shutoff valve** to connect to the cold water line. The shutoff valve should have a water inlet with a minimum inside diameter of 5/32 in. at the point of connection to the COLD WATER LINE. Saddle-type shutoff valves are included in many water supply kits. Before purchasing, make sure a saddle-type valve complies with your local plumbing codes.

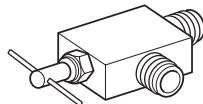

NOTE

A self piercing saddle type water valve should not be used.

Water Line Installation Instructions

WARNING

When using any electrical device (such as a power drill) during installation, be sure the device is battery powered, double insulated or grounded in a manner that will prevent the hazard of electric shock.

Install the shutoff valve on the nearest frequently used drinking water line.

- 1 SHUT OFF THE MAIN WATER SUPPLY
Turn on the nearest faucet to relieve the pressure on the line.

- 2 CHOOSE THE VALVE LOCATION

Choose a location for the valve that is easily accessible. It is best to connect into the side of a vertical water pipe. When it is necessary to connect into a horizontal water pipe, make the connection to the top or side, rather than at the bottom, to avoid drawing off any sediment from the water pipe.

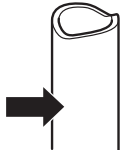

- 3 DRILL THE HOLE FOR THE VALVE

Drill a 1/4 in. hole in the water pipe using a sharp bit. Remove any burrs resulting from drilling the hole in the pipe. Be careful not to allow water to drain into the drill. Failure to drill a 1/4 in. hole may result in reduced ice production or smaller cubes.

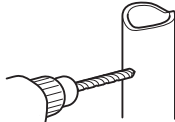

NOTE

The hookup line cannot be white, plastic tubing. Licensed plumbers must use only copper tubing (NDA tubing #49595 or #49599) or Cross Link Polyethylene (PEX) tubing.

- 4 FASTEN THE SHUTOFF VALVE

Fasten the shutoff valve to the cold water pipe with the pipe clamp.

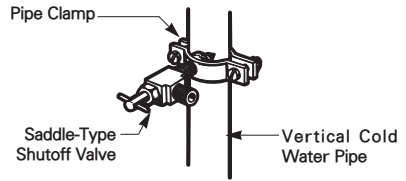

NOTE

Commonwealth of Massachusetts Plumbing Codes 248CMR shall be adhered to. Saddle valves are illegal and their use is not permitted in Massachusetts. Consult with your licensed plumber.

- 5 TIGHTEN THE PIPE CLAMP

Tighten the clamp screws until the sealing washer begins to swell.

NOTE: Do not overtighten the clamp or you may crush the tubing.

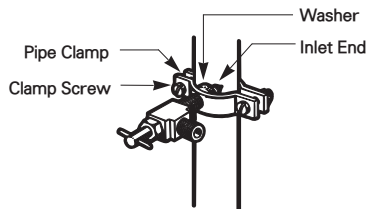

- 6 ROUTE THE TUBING

Route the tubing between the cold water line and the refrigerator.

Route the tubing through a hole drilled in the wall or floor (behind the refrigerator or adjacent base cabinet) as close to the wall as possible.

NOTE

Be sure there is sufficient extra tubing (about 8 feet coiled into 3 turns of about 10 in. diameter) to allow the refrigerator to move out from the wall after installation.

7 CONNECT THE TUBING TO THE VALVE

Place the compression nut and ferrule (sleeve) for the copper tubing onto the end of the tubing and connect it to the shutoff valve. Make sure the tubing is fully inserted into the valve. Tighten the compression nut securely.

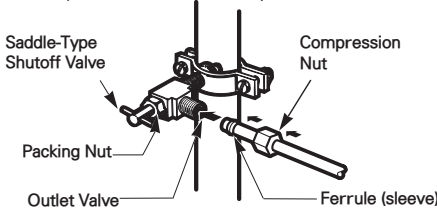

8 FLUSH OUT THE TUBING

Turn the main water supply on and flush out the tubing until the water is clear.

Shut the water off at the water valve after about one quart of water has been flushed through the tubing.



9 CONNECT THE TUBING TO THE REFRIGERATOR

NOTE: Before making the connection to the refrigerator, be sure that the refrigerator power cord is not plugged into the wall outlet.

- Remove the plastic flexible cap from the water valve.
- Place the compression nut and ferrule (sleeve) onto the end of the tubing as shown.
- Insert the end of the copper tubing into the connection as far as possible. While holding the tubing, tighten the fitting.

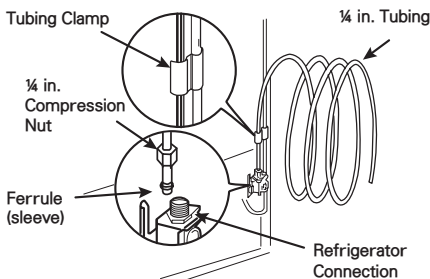

10 TURN THE WATER ON AT THE SHUTOFF VALVE

Tighten any connections that leak.

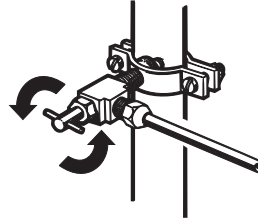

CAUTION

Check to see if leaks occur at the water line connections.

11 PLUG IN THE REFRIGERATOR

Arrange the coil of tubing so that it does not vibrate against the back of the refrigerator or against the wall. Push the refrigerator back to the wall.

12 START THE ICEMAKER

Turn the icemaker ON at the control panel.

The icemaker will not begin to operate until it reaches its operating temperature of 15°F (-9°C) or below. It will then begin operation automatically if the icemaker has been turned ON.

Turning On The Power

Plug in the refrigerator.

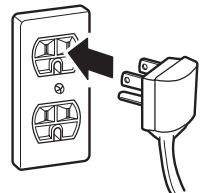

CAUTION

- Connect to a rated power outlet.
- Have a certified electrician check the wall outlet and wiring for proper grounding.
- Do not damage or cut off the ground terminal of the power plug.

Leveling

After installing, plug the refrigerator's power cord into a 3-prong grounded outlet and push the refrigerator into the final position.

The refrigerator has two front leveling legs—one on the right and one on the left. Adjust the legs to alter the tilt from front-to-back or side-to-side. If the refrigerator seems unsteady, or you want the doors to close more easily, adjust the refrigerator's tilt using the instructions below:

- 1 Turn the leveling leg to the left to raise that side of the refrigerator or to the right to lower it. It may take several turns of the leveling leg to adjust the tilt of the refrigerator.

NOTE

A flare nut wrench works best, but an open-end wrench will suffice. Do not over-tighten.

- 2 Open both doors again and check to make sure that they close easily. If the doors do not close easily, tilt the refrigerator slightly more to the rear by turning both leveling legs to the left. It may take several more turns, and you should turn both leveling legs the same amount.

Door Alignment

If the floor is not flat, the door heights may differ. In this case, use the following method to adjust the difference.

Adjusting Door Height

Adjusting Fridge Door Height

Open the fridge door and use a wrench to rotate the door hinge bolt as shown.

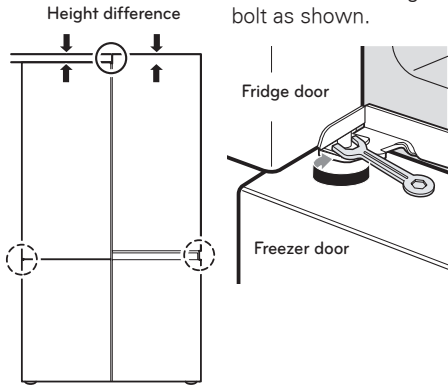

Adjusting Freezer Door Height

Open the freezer door and use a wrench to rotate the door hinge bolt as shown.

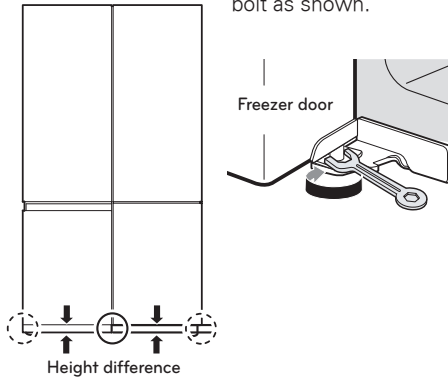

HOW TO USE

Before use

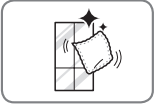

Clean the refrigerator.

Clean the refrigerator thoroughly and wipe off all dust that accumulated during shipping.



CAUTION

- Do not scratch the refrigerator with a sharp object or use a detergent that contains alcohol, a flammable liquid or an abrasive when removing any tape or adhesive from the refrigerator.
- Do not peel off the model or serial number label or the technical information on the rear surface of the refrigerator.

NOTE

Remove adhesive residue by wiping it off with your thumb or dish detergent.

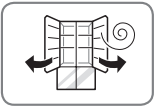

Open refrigerator and freezer doors to ventilate the interior.

The inside of the refrigerator may smell like plastic at first. Remove any adhesive tape from inside the refrigerator and open the refrigerator and the freezer doors for ventilation.

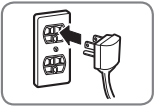

Connect the power supply.

Check if the power supply is connected before use.
Read the "Turning On The Power" section.

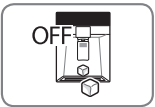

Turn off the icemaker if the refrigerator is not yet connected to the water supply.

Turn off the automatic icemaker and then plug the power plug of the refrigerator into the grounded electrical outlet.

* This is applicable only to certain models.



CAUTION

Running the automatic icemaker before connecting it to the water supply may cause the refrigerator to malfunction.

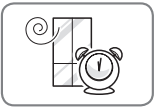

Wait for the refrigerator to cool.

Allow your refrigerator to run for at least two to three hours before putting food in it. Check the flow of cold air in the freezer compartment to ensure proper cooling.



CAUTION

Putting food in the refrigerator before it has cooled could cause the food to spoil, or a bad odor could linger inside the refrigerator.

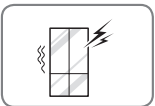

The refrigerator makes a loud noise after initial operation.

This is normal. The volume will decrease as the temperature lowers.

Wi-Fi Eclipse Display

Depending on the model, some of the following functions may not be available.

Wi-Fi Eclipse Display Features

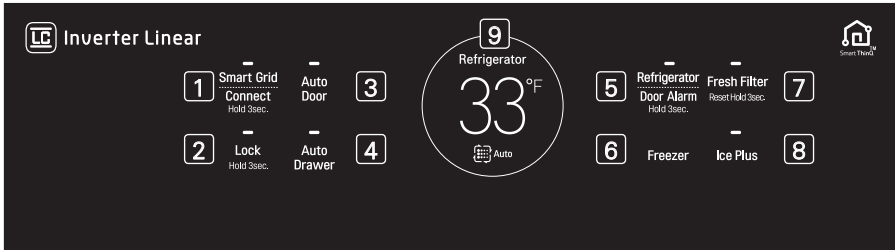

1 Smart Grid / Connect

Smart Grid

Press the Smart Grid button to turn the Smart Grid function On/Off. When the function is on, the icon illuminates. The Smart Grid function automatically turns on when the refrigerator is connected to the Wi-Fi network. When the refrigerator is responding to a Demand Response (DR) message from the electric company, the Grid text illuminates.

Connect

The Connect button, when used with the LG Electronics Smart Refrigerator smart phone app, allows the refrigerator to connect to your home's Wi-Fi network. Refer to the *Smart Features* section for information on the initial setup of the application. The Connect icon indicates the status of the refrigerator's network connection. When the refrigerator is connected to the network, the Connect icon is illuminated. Press and hold the Connect button for 3 seconds to connect to the network. The icon will blink while the connection is being made, then turn on once the connection is successfully made. To disconnect, press and hold the button again.

2 Lock

The Lock function disables every other button on the display.

- When power is initially connected to the refrigerator, the Lock function is off.
- To activate the Lock function, press and hold the Lock button until the lock indicator appears in the display. The other buttons are now disabled.
- To disable the Lock function, press and hold the Lock button for approximately three seconds.

3 Auto Open Door

The right refrigerator door opens automatically if you place a foot near the motion sensor at the bottom of the door. This is convenient when you have both hands full of groceries and need to open the refrigerator door. To set the Auto Open Door function, press the button repeatedly to toggle between the ON, Sound Off, and OFF settings.

Using the Auto Open Door Function

1. When the Auto Open Door Function is enabled, text is displayed on the floor near the motion sensor.

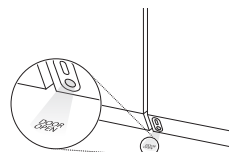

2. Pass one foot in front of the motion sensor and step on the displayed text. The right door opens. If the door opens less than 20 degrees and is not opened further, it will close automatically after 3 seconds.

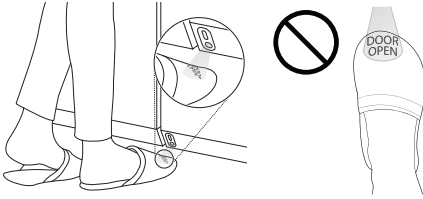
**NOTE**

Place your foot close enough to the sensor that the text appears on top of the foot, not just on the toes.

CAUTION

Disable the Auto Open Door function if you have young children or people lacking in cognitive ability in the home. They could be injured if the door opens unexpectedly while they are nearby.

NOTE

- The displayed text may not be readable on some flooring materials, but this will not affect the performance of the Auto Open Door function.
- If flooring material is highly reflective (metal, glass tile), the motion sensor may malfunction and the Auto Open Door function may not work properly.
- Reflective objects placed in front of the motion sensor may cause the text to display, but the text disappears if no movement is detected.
- If a pet passes by below when a person stands in front of the product, automatic door open function may be operated.

4 Auto Open Drawer

When Auto Open Drawer is enabled, the freezer drawers automatically open when the freezer door is opened. The drawers automatically close when the freezer door is closed.

Setting Auto Open Drawer

Press Auto Drawer to activate or deactivate the function. When the function is activated, an icon appears on the display.

Using Auto Open Drawer

Open the freezer door at least 85 degrees to automatically open the drawers. Slowly close the door to automatically close the drawers.

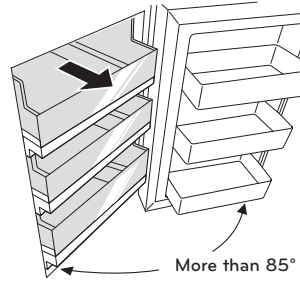
**CAUTION**

- Do not use excessive force to push or pull the freezer drawers.
 - Do not slam the freezer door shut while the drawers are open.
- Failure to follow these warnings may result in personal injury or damage to the product.

5 Refrigerator/Door Alarm**Refrigerator**

- Indicates the set temperature of the refrigerator compartment in Celsius (°C) or Fahrenheit (°F). The refrigerator temperature control ranges from 33°F to 46°F (1°C to 8°C). The recommended temperature setting for the refrigerator compartment is 37°F (3°C).

Door Alarm

- The door alarm sounds when a refrigerator or freezer door is left open for more than 60 seconds.
- To stop the alarm, close the doors.
- The door alarm is enabled by default. To disable the door alarm, press and hold Door Alarm for three seconds.

6 Freezer

Indicates the set temperature of the freezer compartment in Celsius (°C) or Fahrenheit (°F). The freezer temperature control ranges from -6°F to 8°F (-21°C to -13°C). The recommended temperature setting for the freezer compartment is 0°F (-18°C).

To change the temperature mode from °F to °C (or vice versa) press and hold the Refrigerator and Freezer temperature buttons simultaneously for approximately five seconds. The temperature indication on the display window switches between Celsius and Fahrenheit.

NOTE

The displayed temperature is the target temperature, and not the actual temperature of the refrigerator. The actual refrigerator temperature depends on the food inside the refrigerator.

7 Fresh Filter

The Fresh Air Filter helps remove odors from the refrigerator. The Fresh Air Filter has two settings, Auto and Power(PWR). In Auto mode, the Fresh Air Filter will cycle on and off in increments of ten minutes on and 110 minutes off. If set to the Power(PWR) mode, the Fresh Air Filter will stay on continuously for four hours, cycling on and off in increments of ten minutes on and five minutes off. After four hours, the Fresh Air Filter will switch back to Auto mode.

- Press the Fresh Air Filter button once for Power(PWR) mode.
- Press the Fresh Air Filter button again to switch back to Auto mode.

8 Ice Plus

This function increases both ice making and freezing capabilities.

- Press Ice Plus to illuminate the icon in the display and activate the function for 24 hours. After 24 hours, the icon and the function automatically turn off.
- To deactivate the function manually, press Ice Plus again.

9 Display

The display indicates the current status of the refrigerator. Press any button to display the current setting for that function.

Using the Wi-Fi Eclipse Display

- To turn the display on, open a refrigerator or freezer door or knock twice on the InstaView™Door-in-Door® to activate the interior LED
- The display turns off automatically five seconds after all the doors are closed or five seconds after you have knocked twice on the InstaView™Door-in-Door®.
- The display buttons operate using static electricity. Wear gloves while cleaning to avoid activating button functions.
- Keep the display clean and free from foreign substances. Skin must contact the buttons directly for them to properly function.
- Wipe any moisture off the display before using it. Moisture on the display may interfere with the functioning of the buttons.



CAUTION

Display Mode (For Store Use Only)

The Display Mode disables all cooling in the refrigerator and freezer sections to conserve energy while on display in a retail store. When you turn on the interior display, "Demo Mode" appears in the display.

To deactivate / activate:

With InstaView™Door-in-Door® opened, press and hold the Refrigerator and Ice Plus buttons at the same time for five seconds. When demo mode is activated, the control panel will beep and the temperature settings will display as "Demo Mode" for five seconds and then return to normal temperature display. Use the same procedure to deactivate the Display Mode.

Smart Features

To use the Smart Features on your refrigerator, you will need the following devices and apps:

1. a wireless router and home Wi-Fi network
2. the LG Smart Grid refrigerator
3. an Android-based smart phone
4. the LG Smart Refrigerator app from the Google Play Store.

NOTE

To use the Smart Grid feature, you must also register for the Smart Grid (Demand Response) service with your local electric utility company. The company must provide Demand Response service.

Setting Up the Smart App and Connecting the Refrigerator

- 1 Create an account at Smart ThinQ.
<https://us.smarthinq.com/>
You will use the ID and password from this account in the smart phone application.
- 2 Download the smart phone app from the Google Play Store. (LG Smart Refrigerator app)
- 3 In the app, select the Smart Model.
- 4 Log in to the app using the Smart ThinQ ID and password created in step 1.
- 5 When prompted, select the Non Touch Screen Model.
- 6 Choose your home wireless router from the list of routers in the app. Your refrigerator and smart phone must both be connected to the same Wi-Fi network.
- 7 If necessary, enter the password for your router and click the connect button in the app.
- 8 Make sure the refrigerator display is active by pressing any button. Press and hold the Smart Grid button on the refrigerator for three seconds. The Connect LED should blink while the connection is being made.

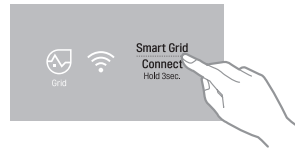

NOTE

You must connect the refrigerator to the internet using a wireless router on your home network. Tethering to a mobile phone, hotspot, or an unsecured network, for example, will cause unstable functionality.

- 9 The app will automatically go through the process of registering your product on the network, using the information you've provided. This may take some time, and the Connect LED will continue to blink during this process. After the registration process is completed, a message is displayed and the app will proceed to the Home screen.
- 10 Check that the Connect LED is illuminated to confirm that the Wi-Fi network is connected. You can now use the app to control the Smart Features on your refrigerator.

LG Smart Refrigerator App - What's Included

Food Manager

Allows you to keep track of items in your refrigerator and freezer, so you can be alerted when they are near their use-by dates, generate grocery lists, and link to related recipes.

Recipes

Features recipes from the Food Channel, searchable by ingredient, course, cuisine, total time required, and the food in your refrigerator (if entered in the Food Manager). Automatically makes grocery lists from chosen recipes.

Grocery

Makes and manages grocery lists from items in your refrigerator or recipes.

Refrigerator Manager

Allows you to control the refrigerator and freezer temperature settings, air filter, water filter, Ice Plus, Smart Saving, and Energy Monitoring from your smart phone.

Smart Diagnosis

Allows you to diagnose and troubleshoot problems with your refrigerator.

Settings

Allows you to set various options on the refrigerator and in the app.

Smart Grid Function

When the refrigerator operates in Smart Grid mode, the Smart Refrigerator function can control energy usage or delay the operation of some functions to save energy during peak usage periods.

- You can override the Smart Grid function at any time (using the Smart Grid button or application).
- To use the Smart Grid function, you need to register your appliance with your electric utility company.

Using the Smart Grid Function

This feature responds to notification events from your utility company to run high energy-consuming tasks during off-peak periods when demand is lower. These notification events are known as Demand Response signals.

If the refrigerator receives a Demand Response signal from the utility company, the refrigerator will turn on the Grid LED on the refrigerator display and control its power consumption according to the signal.

The refrigerator will respond to the signals received from the utility company as long as product performance is maintained.

If the refrigerator receives a Demand Response signal, the refrigerator will operate in Delay Appliance Load (DAL) or Temporary Appliance Load Reduction (TALR) mode.

Delay Appliance Load (DAL): The refrigerator responds to a DAL signal by providing a moderate load reduction for the duration of the delay period. This mode controls functions that consume a lot of energy such as adjusting the cooling system, running the defrost cycle, and making ice.

- When the refrigerator operates in DAL mode, the Grid LED is illuminated on the refrigerator display.
- DAL mode is automatically deactivated after it lasts for the amount of time stipulated by the DAL signal (max. 4 hours) or when you override the Smart Grid function.

Temporary Appliance Load Reduction (TALR) :

The refrigerator responds to a TALR signal by aggressively reducing the load for a short time period, typically 10 minutes. This mode reduces energy consumption by stopping the compressor and controlling the functions that consume a lot of energy such as the defrost cycle and fan.

- When the refrigerator operates in TALR mode, the Grid LED is illuminated on the refrigerator display.
- TALR mode is automatically deactivated after it lasts for the received duration (max. 10 minutes), or when you override the Smart Grid function. The mode is immediately deactivated and the refrigerator returns to its normal state when the door is opened or closed, or the dispenser is used.

Smart Features (continued)

Override Smart Grid Mode

If you want the refrigerator to ignore the Demand Response signal from the utility company, you can override the Smart Grid function by pushing the Smart Grid button while the refrigerator is in Smart Grid mode.

When you override the Smart Grid function, the refrigerator ignores the Demand Response signal and is no longer controlled by the utility company until the next Demand Response signal is sent.

You can also override the Smart Grid function using the smart phone app.

Open API

LG Open API

You can manage Smart Grid features for the LG Smart Refrigerator.

Please check the detailed specifications on the notice page on us.smarthinq.com.

API list :

Demand response

- Send demand response signal

Power saving

- Set saving mode
- Get schedule of DR/Delay Defrost

Energy monitoring

- Get setting temperature
- Get door open event
- Get energy consumption

Delay defrost capability

- Insert a delay defrost schedule event
- Update a delay defrost schedule event
- Delete a delay defrost schedule event
- Get the delay defrost schedule

Smart Grid Application Features

1 Smart Saving_Demand Response

You can lower energy usage based on Demand Response (DR) signals from the utility company.

If the refrigerator is operating in Smart Saving mode according to the DR signal, you can see a pop up.

Smart Saving_Delay Defrost

Lower energy usage based on time period.

2 Energy monitoring

The refrigerator can check number of door openings and power consumption.

3 Remote Control

You can control the Refrigerator Temperature, Fresh Air Filter and Ice Plus from the smart phone app.

4 Push messages.

- When the door is open over ten minutes, you will receive a push message.
- When Ice Plus is finished, you will receive a push message.

Open Source Software Notice

Information

To obtain the source code that is contained in this product that was developed under GPL, LGPL, MPL, and other open source licenses, visit <http://opensource.lge.com>. In addition to the source code, all referred license terms, warranty disclaimers and copyright notices are available for download.

LG Electronics will also provide open source code on CD-ROM for a charge covering the cost of performing such distribution (such as the cost of media, shipping, and handling) upon email request to opensource@lge.com. This offer is valid for three (3) years from the date on which you purchased the product.

Wireless LAN module Specifications	
Model	LCW-003
Frequency Range	2412 to 2462MHz
Output Power (Max.)	IEEE 802.11b: 17.56 dBm IEEE 802.11g: 25.53 dBm IEEE 802.11n: 25.29 dBm

FCC Notice (For transmitter module contained in this product)

This equipment has been tested and found to comply with the limits for a Class B digital device, pursuant to Part 15 of the FCC Rules. These limits are designed to provide reasonable protection against harmful interference in a residential installation. This equipment generates, uses, and can radiate radio frequency energy and, if not installed and used in accordance with the instructions, may cause harmful interference to radio communications. However, there is no guarantee that interference will not occur in a particular installation. If this equipment does cause harmful interference to radio or television reception, which can be determined by turning the equipment off and on, the user is encouraged to try to correct the interference by one or more of the following measures:

- Reorient or relocate the receiving antenna.
- Increase the separation between the equipment and the receiver.
- Connect the equipment to an outlet on a circuit different from that to which the receiver is connected.
- Consult the dealer or an experienced radio/TV technician for help.

This device complies with part 15 of the FCC Rules. Operation is subject to the following two conditions:

- 1) this device may not cause harmful interference and
- 2) this device must accept any interference received, including interference that may cause undesired operation of the device.

Any changes or modifications in construction of this device which are not expressly approved by the party responsible for compliance could void the user's authority to operate the equipment.

FCC RF Radiation Exposure Statement

This equipment complies with FCC radiation exposure limits set forth for an uncontrolled environment. This transmitter must not be co-located or operating in conjunction with any other antenna or transmitter.

This equipment should be installed and operated with minimum distance 20 cm (7.8 inches) between the antenna and your body. Users must follow the specific operating instructions for satisfying RF exposure compliance.

Industry Canada Statement (For transmitter module contained in this product)

This device complies with Industry Canada's licence-exempt RSSs. Operation is subject to the following two conditions:

- 1) this device may not cause interference; and
- 2) this device must accept any interference, including interference that may cause undesired operation of the device.

IC Radiation Exposure Statement

This equipment complies with IC radiation exposure limits set forth for an uncontrolled environment. This equipment should be installed and operated with minimum distance 20 cm (7.8 inches) between the antenna & your body.

NOTE

The manufacturer is not responsible for any radio or TV interference caused by unauthorized modifications to this equipment. Such modifications could void the user's authority to operate the equipment.

FCC Regulation Notice

This device complies with Part 18 of the FCC Rules. Operation is subject to the following two conditions:

- (1) this device may not cause harmful interference and
- (2) this device must accept any interference received, including interference that may cause undesired operation of the device.

Any changes or modifications in construction of this device which are not expressly approved by the party responsible for compliance could void the user's authority to operate the equipment.

This device has no serviceable parts.

This equipment generates, uses, and can radiate radio frequency energy and, if not installed and used in accordance with the instructions, may cause harmful interference to radio communications. However, there is no guarantee that interference will not occur in a particular installation. If this equipment does cause harmful interference to radio or television reception, which can be determined by turning the equipment off and on, the user is encouraged to try to correct the interference by one or more of the following measures:

- Reorient or relocate the receiving antenna.
- Increase the separation between the equipment and the receiver.
- Connect the equipment to an outlet on a circuit different from that to which the receiver is connected.
- Consult the dealer or an experienced radio/TV technician for help.

Model	FCC ID
LUPXS3186N	BEJF31GDA
LUPXC2386N	BEJF23GDA07

Industry Canada Statement

This device complies with Industry Canada's license-exempt RSSs. Operation is subject to the following two conditions:

- (1) This device may not cause interference; and
- (2) This device must accept any interference, including interference that may cause undesired operation of the device.

Wireless Power Transfer Specifications	
Frequency	350 kHz ± 20kHz
Rated voltage	DC 12V
Delivered power	Less than or equal to 1.2W per shelf
Transmission mode	Electromagnetic induction mode

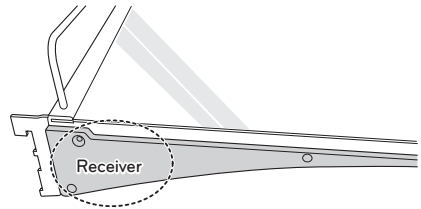
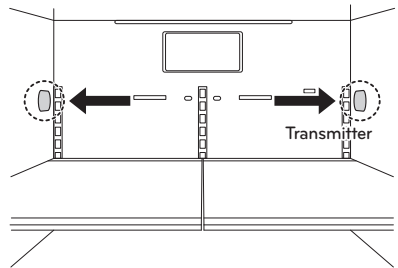

NOTE

- Installing the shelf on the right side will disable the shelf light.
- The shelf light turns on only when the shelf is installed in the highest or lowest positions.
- Foreign objects and dirt between the shelf and the inner cabinet wall could prevent the shelf light from turning on.
- The shelf light turns on when the door is opened.
- The shelf light turns off after seven minutes or when the door is closed.

In-Door Ice Bin

Depending on the model, some of the following functions may not be available.

CAUTION

- Keep hands and tools out of the ice compartment door and dispenser chute. Failure to do so may result in damage or personal injury.
- The icemaker stops producing ice when the in-door ice bin is full. If you need more ice, empty the ice bin into the extra ice bin in the freezer compartment. During use, ice may build up higher around the sensor than in the rest of the bin, causing the icemaker to stop producing ice before the bin is full. Shaking the ice bin to level the ice within it can reduce this problem.
- To avoid damaging the icemaker, do not store cans or other items in the ice bin.
- Keep the ice compartment door closed tightly. If the ice compartment door is not closed tightly, the cold air in the ice bin will freeze food in the refrigerator compartment. This could also cause the icemaker to stop producing ice.
- If the icemaker is turned OFF for an extended period of time, the ice compartment will gradually warm up to the temperature of the refrigerator compartment. To prevent ice cubes from melting and leaking from the dispenser, ALWAYS empty the ice bin when the icemaker is set to OFF for more than a few hours.

- 2 To remove the in-door ice bin, grip the front handle, slightly lift the lower part, and slowly pull out the bin as shown.

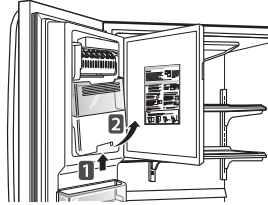

Assembling the In-Door Ice Bin

- 1 Carefully insert the in-door ice bin while slightly slanting it to avoid contact with the icemaker.

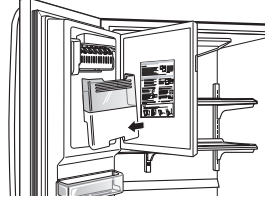

- 2 Avoid touching the auto shutoff (feeler arm) when replacing the ice bin. See the label on the ice compartment door for details.

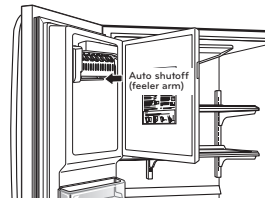

Detaching the In-Door Ice Bin

- 1 Gently pull the handle to open the ice compartment.

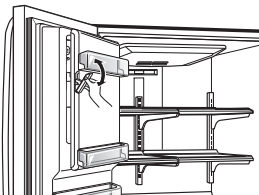

CAUTION

When handling the ice bin, keep hands away from the icemaker tray area to avoid personal injury.



Automatic Icemaker

Depending on the model, some of the following functions may not be available.

Ice is made in the automatic icemaker and sent to the dispenser. The icemaker will produce 70-182 cubes in a 24-hour period, depending on freezer compartment temperature, room temperature, number of door openings and other operating conditions.

- It takes about 12 to 24 hours for a newly installed refrigerator to begin making ice. Wait 72 hours for full ice production to occur.
- Ice making stops when the in-door ice bin is full. When full, the in-door ice bin holds approximately 6 to 8 (12-16 oz) glasses of ice.
- Foreign substances or frost on the auto shutoff (feeler arm) can interrupt ice production. Make sure the feeler arm is clean at all times for proper operation.
- To increase ice production, use the Ice Plus function. The function increases both ice making and freezing capabilities.

WARNING

Personal Injury Hazard

DO NOT place fingers or hands on the automatic ice making mechanism while the refrigerator is plugged in.

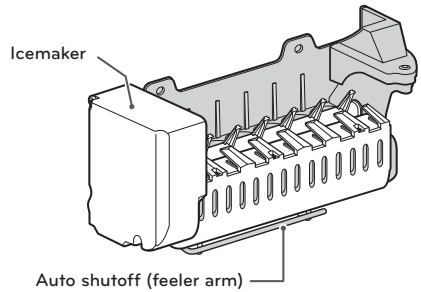

Turning the Automatic Icemaker On or Off

To turn the automatic icemaker On/Off, press and hold the Ice On/Off button on the control panel for 3 seconds.

Automatic Icemaker (continued)



CAUTION

- The first ice and water dispensed may include particles or odor from the water supply line or the water tank.
- Throw away the first few batches of ice. This is also necessary if the refrigerator has not been used for a long time.
- Never store beverage cans or other items in the ice bin for the purpose of rapid cooling. Doing so may damage the icemaker or the containers may burst.
- If discolored ice is dispensed, check the water filter and water supply. If the problem continues, contact a qualified service center. Do not use the ice or water until the problem is corrected.
- Keep children away from the dispenser. Children may play with or damage the controls.
- The ice passage may become blocked with frost if only crushed ice is used. Remove the frost that accumulates by removing the ice bin and clearing the passage with a rubber spatula. Dispensing cubed ice can also help prevent frost buildup.
- Never use thin crystal glass or crockery to collect ice. Such containers may chip or break resulting in glass fragments in the ice.
- Dispense ice into a glass before filling it with water or other beverages. Splashing may occur if ice is dispensed into a glass that already contains liquid.
- Never use a glass that is exceptionally narrow or deep. Ice may jam in the ice passage and refrigerator performance may be affected.
- Keep the glass at a proper distance from the ice outlet. A glass held too close to the outlet may prevent ice from dispensing.
- To avoid personal injury, keep hands out of the ice door and passage.
- Never remove the dispenser cover.
- If ice or water dispenses unexpectedly, turn off the water supply and contact a qualified service center.

When You Should Turn the Icemaker Off

- When the water supply will be shut off for several hours.
- When the ice bin is removed for more than one or two minutes.
- When the refrigerator will not be used for several days.

NOTE

The ice bin should be emptied when the Ice On/Off button is set to the Off mode.

Normal Sounds You May Hear

- The icemaker water valve will buzz as the icemaker fills with water. If the Ice on/off button is set to On, the icemaker will buzz even if it has not yet been hooked up to water. To stop the buzzing, press the Ice on/off button to set it to the Off position.

NOTE

Keeping the icemaker on before the water line is connected can damage the icemaker.

- You will hear the sound of cubes dropping into the bin and water running in the pipes as the icemaker refills.

Preparing for Vacation

Set the Ice On/Off button to Off and shut off the water supply to the refrigerator.

NOTE

The ice bin should be emptied any time the Ice On/Off button is turned Off.

If the ambient temperature is expected to drop below freezing, have a qualified technician drain the water supply system to prevent serious property damage due to flooding caused by ruptured water lines or connections.

Ice and Water Dispenser

CAUTION

Keep children away from the dispenser to prevent them from playing with or damaging the controls.

Dispenser

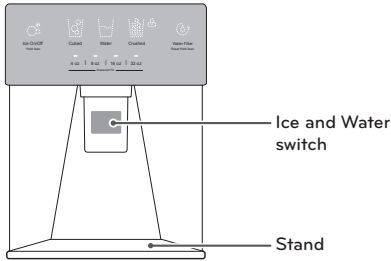

Using the Dispenser

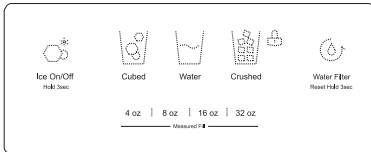

- 1 Turn the icemaker on or off by pressing and holding Ice On/Off for three seconds.
- 2 To dispense cold water or ice, press the text on the dispenser control panel to select Cubed ice (📏), Water (🍵), or Crushed ice (📏📏).

CAUTION

Throw away the first few batches of ice (about 24 cubes). This is also necessary if the refrigerator has not been used for a long time.

Using the Measured Fill

The measured fill function dispenses pre-measured amounts of water automatically.

- 1 Select the desired amount from the Measured Fill buttons on the dispenser control panel.
- 2 Depress the dispenser switch with a container.
- 3 To stop the measured fill, release the dispenser switch.

NOTE

- If discolored ice is dispensed, check the water filter and water supply. If the problem continues, contact a qualified service center. Do not use the ice or water until the problem is corrected.
- The dispenser will not operate when either of the refrigerator doors are open.
- If dispensing water or ice into a container with a small opening, place it as close to the dispenser as possible.
- Some dripping may occur after dispensing. Hold the cup beneath the dispenser for a few seconds after dispensing to catch all of the drops.

Cleaning the Dispenser Stand

- 1 Raise up, holding both ends.

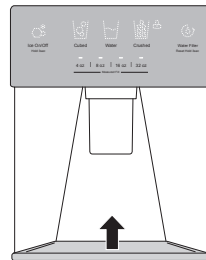

- 2 Wipe out dirty areas with a clean cloth.

Locking the Dispenser

Press and hold the Lock button on the interior display for three seconds to lock the dispenser and all of the display panel functions. Follow the same instructions to unlock.

Storing Food

Food Preservation Location

Each compartment inside the refrigerator is designed to store different types of food. Store your food in the optimal space to enjoy the freshest taste.

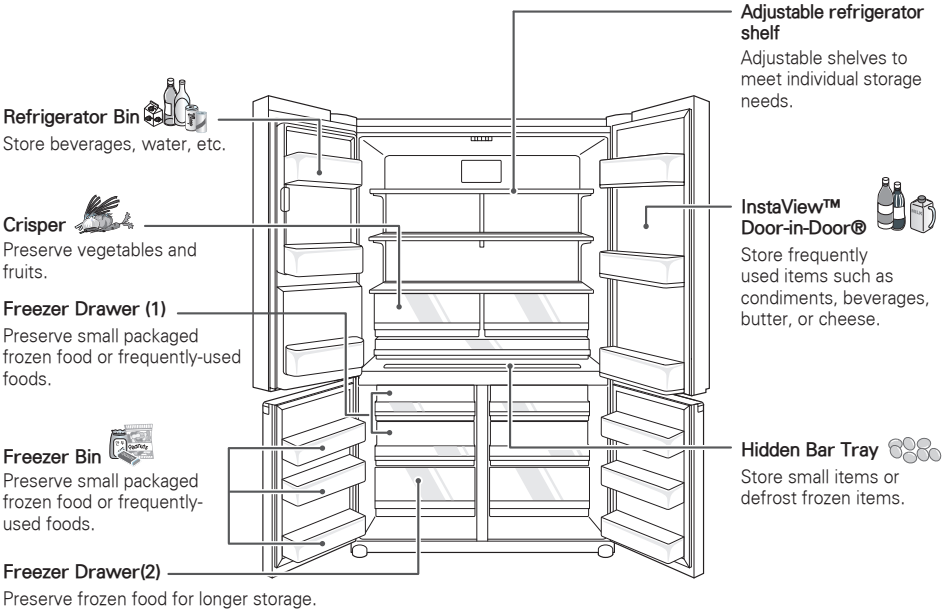

CAUTION

- Do not store food with high moisture content toward the top of the refrigerator. The moisture could come in direct contact with the cold air and freeze.
- Wash food before storing it in the refrigerator. Vegetables and fruit should be washed, and food packaging should be wiped down to prevent adjacent foods from being contaminated.
- If the refrigerator is kept in a hot and humid place, frequent opening of the door or storing a lot of vegetables in the refrigerator may cause condensation to form. Wipe off the condensation with a clean cloth or a paper towel.
- If the refrigerator door or freezer drawer is opened too often, warm air may penetrate the refrigerator and raise its temperature. It can also increase the cost to run the appliance.
- Do not overfill or pack items too tightly into door bins. Doing so may cause damage to the bin or personal injury if items are removed with excessive force.
- The temperature inside the FRESHSteel Container is slightly lower than in the shelf or door bin area.

NOTE

- If you are leaving home for a short period of time, like a short vacation, the refrigerator should be left on. Refrigerated foods that are able to be frozen will stay preserved longer if stored in the freezer.
- If you are leaving the refrigerator turned off for an extended period of time, remove all food and unplug the power cord. Clean the interior, and leave the door open to prevent fungi from growing in the refrigerator.

Food Storage Tips

The following tips may not be applicable depending on the model.

Wrap or store food in the refrigerator in airtight and moisture-proof material unless otherwise noted. This prevents food odor and taste transfer throughout the refrigerator. For dated products, check date code to ensure freshness.

Food	How to
Butter or Margarine	Keep opened butter in a covered dish or closed compartment. When storing an extra supply, wrap in freezer packaging and freeze.
Cheese	Store in the original wrapping until you are ready to use it. Once opened, rewrap tightly in plastic wrap or aluminum foil.
Milk	Wipe milk cartons. For coldest milk, place containers on interior shelf.
Eggs	Store in original carton on interior shelf, not on door shelf.
Fruit	Do not wash or hull the fruit until it is ready to be used. Sort and keep fruit in its original container, in a crisper, or store in a completely closed paper bag on a refrigerator shelf.
Leafy Vegetables	Remove store wrapping and trim or tear off bruised and discolored areas. Wash in cold water and drain. Place in plastic bag or plastic container and store in crisper.
Vegetables with skins (carrots, peppers)	Place in plastic bags or plastic container and store in crisper.
Fish	Store fresh fish and shellfish in the freezer section if they are not being consumed the same day of purchase. It is recommended to consume fresh fish and shellfish the same day purchased.
Leftovers	Cover leftovers with plastic wrap or aluminum foil, or store in plastic containers with tight lids.

Storing Frozen Food

NOTE

Check a freezer guide or a reliable cookbook for further information about preparing food for freezing or food storage times.

Freezing

Your freezer will not quick-freeze a large quantity of food. Do not put more unfrozen food into the freezer than will freeze within 24 hours (no more than 2 to 3 lbs. of food per cubic foot of freezer space). Leave enough space in the freezer for air to circulate around packages. Be careful to leave enough room at the front so the door can close tightly.

Storage times will vary according to the quality and type of food, the type of packaging or wrap used (how airtight and moisture-proof) and the storage temperature. Ice crystals inside a sealed package are normal. This simply means that moisture in the food and air inside the package have condensed, creating ice crystals.

NOTE

Allow hot foods to cool at room temperature for 30 minutes, then package and freeze. Cooling hot foods before freezing saves energy.

Storing Frozen Food (continued)

Packaging

Successful freezing depends on correct packaging. When you close and seal the package, it must not allow air or moisture in or out. If it does, you could have food odor and taste transfer throughout the refrigerator and could also dry out frozen food.

Packaging recommendations:

- Rigid plastic containers with tight-fitting lids
- Straight-sided canning/freezing jars
- Heavy-duty aluminum foil
- Plastic-coated paper
- Non-permeable plastic wraps
- Specified freezer-grade self-sealing plastic bags

Follow package or container instructions for proper freezing methods.

Do not use

- Bread wrappers
- Non-polyethylene plastic containers
- Containers without tight lids
- Wax paper or wax-coated freezer wrap
- Thin, semi-permeable wrap

Adjusting the Refrigerator Shelves

The shelves in the refrigerator are adjustable to meet individual storage needs. Your model may have either glass or wire shelves.

Adjusting the shelves to fit items of different heights will make finding the exact item you want easier. Doing so will also reduce the amount of time the refrigerator door is open which will save energy.

Detaching the Shelf

Tilt up the front of the shelf and lift it straight up. Pull the shelf out.

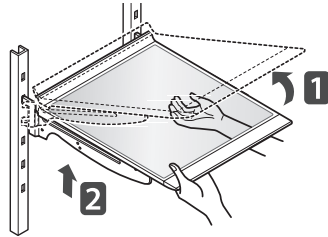

Assembling the Shelf

Tilt the front of the shelf up and guide the rear shelf hooks into the slots at the desired height. Then, lower the front of the shelf so that the hooks drop into the slots.

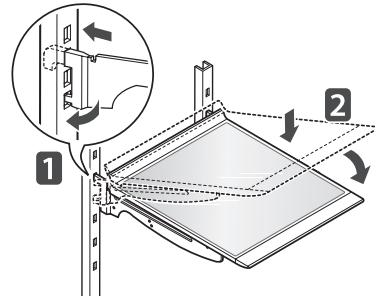

CAUTION

Make sure that shelves are level from one side to the other. Failure to do so may result in the shelf falling or food spilling.

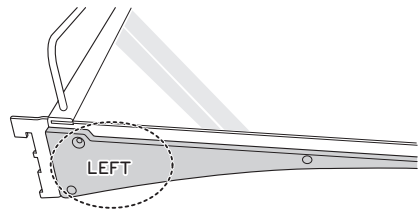

NOTE

- The left side shelf has "LEFT" marking.
- If left and right side shelves are switched, they will not be assembled.

When Closing the Door

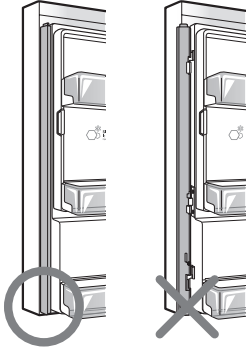

⚠ CAUTION

- To reduce the risk of door scratches and breaking the center door mullion, make sure that the refrigerator door mullion is always folded in.
- The door alarm sounds every 30 seconds if the door remains open longer than one minute. Ensure that the folding mullion is folded in before closing the left-hand door.

CustomChill™ Pantry

This space is used to store meat, fish, dairy products, beverages, and other items that need to be kept chilled.

Setting the CustomChill™ Pantry

Choose a temperature setting for the CustomChill™ pantry by pressing the Select button repeatedly to toggle between Meat, Deli, or Produce.

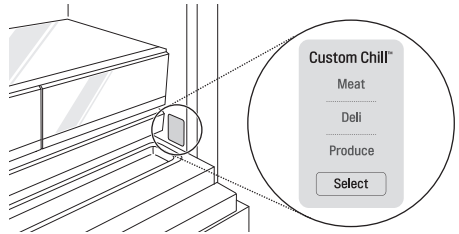

The temperature setting becomes progressively colder from Produce → Deli → Meat.

⚠ CAUTION

Vegetables or fruit may freeze if placed in the CustomChill™ pantry when it is set to Meat or Deli.

Crisper Drawers

Removing the Crisper Drawers

- 1 Pull the crisper drawer out until it stops.

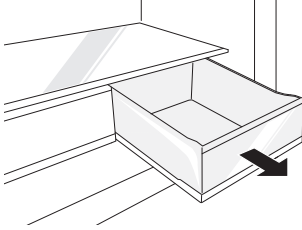

- 2 Slightly lift the crisper drawer to remove it from the support.

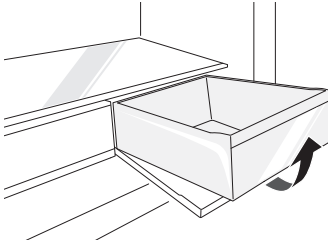

Assembling the Crisper Drawers

- 1 Pull out the crisper drawer support until it stops. Angle the crisper drawer into the opening to place it on the support.

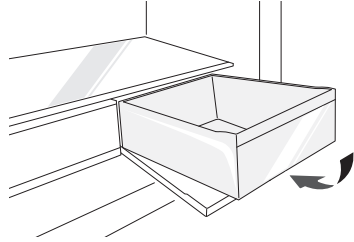

- 2 Slide the crisper drawer back on the support until it drops into place and then close the crisper drawer.

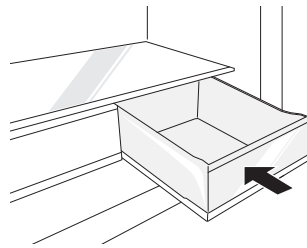

! CAUTION

- Always empty the crispers before removing them, and use both hands when removing and assembling them.
- Make sure that the refrigerator doors are fully open before removing and assembling the crispers.

Removing the Crisper Support Box

- 1 Fully open the fridge door and pull out all the shelves.

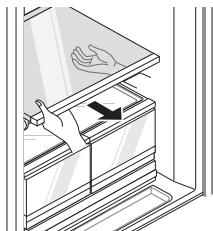

CAUTION

- To avoid injury, always empty the shelves and crisper drawers before removing them.

- 2 Lift the front of the crisper cover until you hear a loud click.

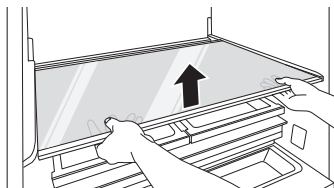

- 3 Tilt the cover slightly and support it with one hand while pulling it out.

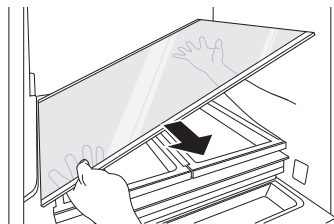

- 4 Open the convertible pantry and lift the front side of the crisper support box with both hands.

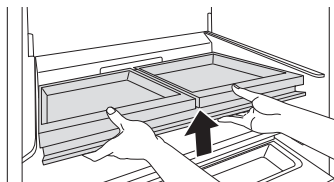

- 5 Slide one hand under the crisper support box and tilt the box up slightly to remove it.

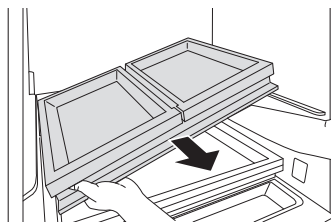

Assembling the Crisper Support Box

- 1 Use one hand to support the bottom of the crisper support box while aligning the inner edge of the box with the groove inside the refrigerator. Lower the box into place.

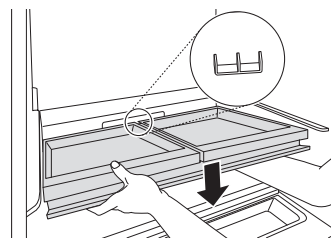

- 2 Angle the crisper cover into the refrigerator and then lower it into place.

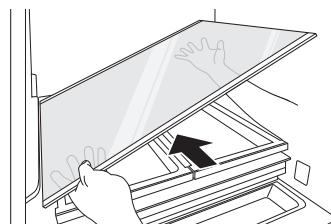

- 3 Slide the crisper cover back until it stops.

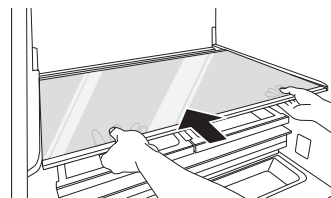

Removing the CustomChill™ Pantry Insert

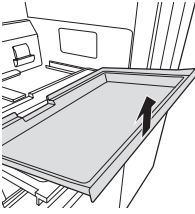

Remove the contents from the CustomChill™ pantry before removing the insert. To remove, open the drawer to full extension, lift the front of the insert, and pull it out.

Hidden Bar Tray

The Hidden Bar Tray compartment is slightly cooler than the shelf or door bin areas, so it is a convenient place to store dairy snacks or other small items you want to keep especially cold. It is also a handy place to defrost meat.

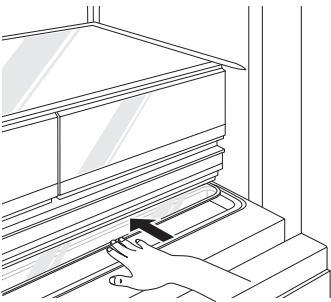

NOTE

To open cover, push handle toward rear of bin to release catch.
To close cover, slide cover over bin until catch clicks into place.

CAUTION

- Be careful when handling and storing larger eggs. They can be broken if the cover is not completely closed and the drawer above is pushed in.
- Store foods like tofu, celery or lettuce which have high water content or freeze easily on the interior shelves at the front.

InstaView™ Door-in-Door®

Knock twice on the center of the glass panel to reveal the contents of the door bins without opening the door and allowing the cold air to escape.

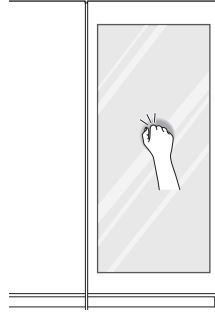

- Knocking twice on the glass panel turns the interior LED on or off.
- The LED turns off automatically after 5 seconds.
- The InstaView™ function is disabled when the right refrigerator door is open, for two seconds after closing the door, and when the ice dispenser is in use.

WARNING

Do not hit the glass door panel with excessive force. Do not allow hard objects like cookware or glass bottles to hit the glass door panel. The glass could break, resulting in a risk of personal injury or product damage.

NOTE

- Tapping the edges of the glass panel may not activate the InstaView™ function.
- The taps on the glass panel must be hard enough to be audible.
- Loud noises near the refrigerator may activate the InstaView™ function.
- The InstaView™ Door-in-Door® will not open if the right refrigerator door is open.

EasyLift Bin

Move the EasyLift bin up and down easily and conveniently as necessary.

- Remove all items from the EasyLift bin before moving it up or down.
- Adjusting the EasyLift Bin allows taller food items to be stored more conveniently.

- 1 To raise the EasyLift bin, hold the bottom of the bin in the center and push the bin up until it clicks into place.

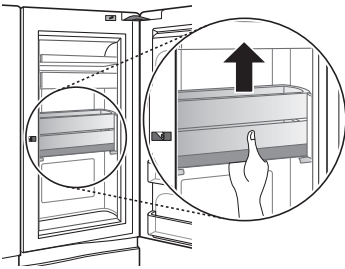

- 2 To lower the EasyLift bin, press up to release the levers at the bottom of the bin and lower the bin until it clicks into place.

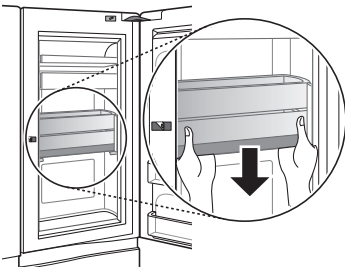

CAUTION

- To avoid personal injury or damage to the bin or its contents, empty the EasyLift bin before moving it up or down.

Freezer Drawer

Use the upper compartments to store packaged frozen foods and frequently-used foods.

Use the lower compartments for larger frozen foods and items stored for longer periods.

- The sliding freezer drawers allow easy access and convenience of use.

Removing the Freezer Drawer

- 1 Pull the freezer drawer out until it stops. Empty all contents out of the drawer before removing it.

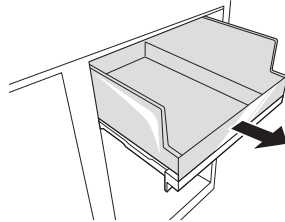

- 2 Lift the empty freezer drawer slightly to remove it from the support.

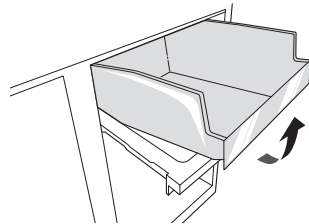

CAUTION

- The drawers are heavy. Always use two hands when removing or assembling the drawers to avoid product damage or personal injury. Always empty drawers before removing them.
- Always open the freezer doors completely before removing or assembling the drawers.

Assembling the Freezer Drawer

- 1 Pull out the drawer support until it stops. Angle the drawer into the space and set it on the support.

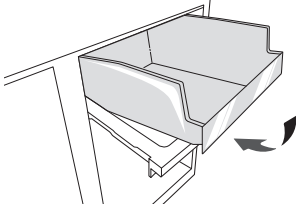

- 2 Slide the drawer back until it lowers into place on the support. Close the drawer.

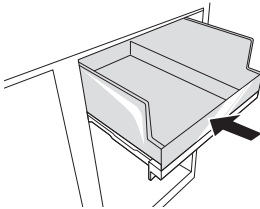

CAUTION

- The drawers are heavy. Always use two hands when removing or assembling the drawers to avoid product damage or personal injury. Always empty drawers before removing or assembling them.
- Always open the freezer doors completely before removing or assembling the drawers.

Removing the Drawer Support

- 1 Press the levers on either side of the drawer support.

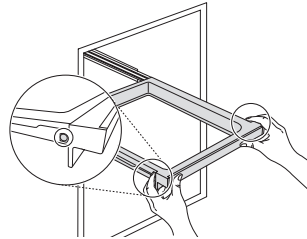

- 2 Keeping both levers pressed, lift the drawer support slightly and remove it from the rail system.

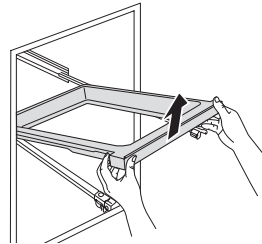

Assembling the Drawer Support

- 1 Pull both drawer rails out until they stop.

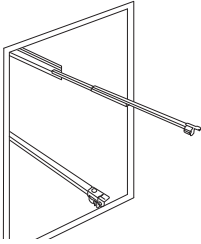

- 2 Line up the bottom edges on the sides of the drawer support with the groove in each rail and then lower the support until it clicks into place.

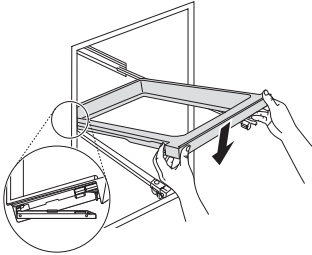

Refrigerator/Freezer Door Bins

You can store small packaged frozen food in the freezer door bins, or small packaged refrigerated food or beverages in the refrigerator door bins, such as milk, water, juice, beer, etc.

Do not store ice cream or foods intended for long-term storage in the freezer door bins.

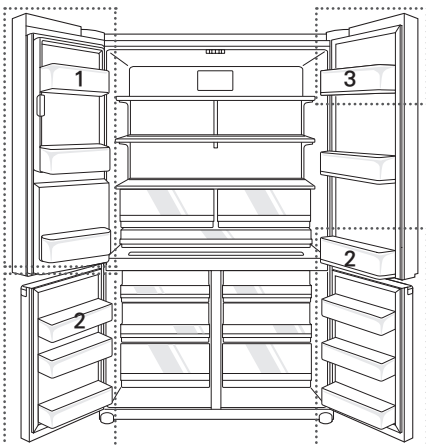

1. Left Refrigerator Door Bins

To remove the door bins, hold the bin with both hands and lift up to remove it.

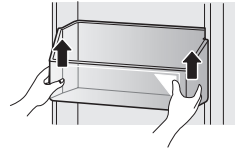

To replace the freezer door bin, align both sides of the bin with the guides and push the bin down until it snaps into place.

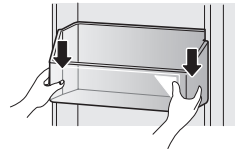

Using the Door-in-Door Bin Bars

The metal bars attached to the Door-in-Door bins can be used as either rails or dividers.

- 1 To keep tall items secure in the door bin, unfold the bar and extend it upward from the top of the bin as a rail.
- 2 To keep bin contents organized, unfold the bar and extend it back into the bin as a divider.
- 3 Fold the bar down into the front of the bin when not in use.

2. Freezer Bins and Lower InstaView™ Door-in-Door® bin

To remove the door bins, tilt the front of the bin up slightly while pulling the sides forward.

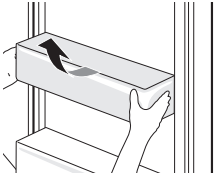

To replace, align the bottom bin tabs with the rail slots then push the bin in until it clicks into place.

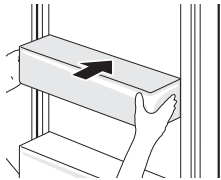

3. Upper InstaView™ Door-in-Door® bin

Removing

- 1 Open the latches underneath the bin by rotating them inwards. Tilt the front of the bin up until the tabs on the top sides clear the rails, then push the bin slightly backward. (It may help to open the glass InstaView™ door.)

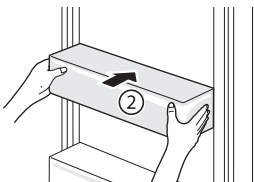
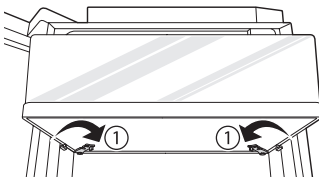

- 2 Hold both ends of the bin and lift.

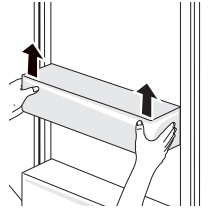

Assembling

- 1 Make sure the bin latches are fully open. Slightly tilt the front of the bin up to align and insert the plastic tabs on the sides of the bin into the indents in the rails. Hold the sides of the bin and pull it slightly forward to correctly position the latches.

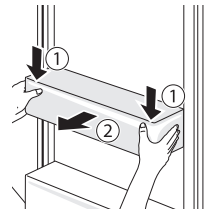
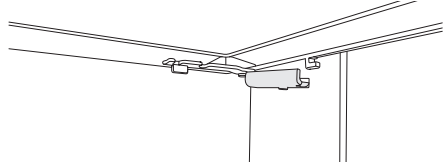

- 2 Close the latches by rotating them toward the sides of the bin.

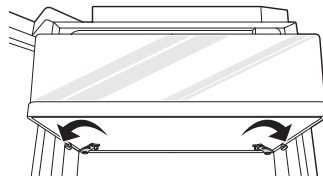

MAINTENANCE

Cleaning

- Both the refrigerator and freezer sections defrost automatically; however, clean both sections about once a month to prevent odors.
- Wipe up spills immediately.
- Always unplug the refrigerator before cleaning.

General Cleaning Tips

- Unplug refrigerator or disconnect power.
- Remove all removable parts, such as shelves, crispers, etc.
- Use a clean sponge or soft cloth and a mild detergent in warm water. Do not use abrasive or harsh cleaners.
- Hand wash, rinse and dry all surfaces thoroughly.

Exterior

Waxing external painted metal surfaces helps provide rust protection. Do not wax plastic parts. Wax painted metal surfaces at least twice a year using appliance wax (or auto paste wax). Apply wax with a clean, soft cloth.

For products with a stainless steel exterior, use a clean sponge or soft cloth and a mild detergent in warm water. Do not use abrasive or harsh cleaners. Dry thoroughly with a soft cloth.



CAUTION

- Do not use a rough cloth or sponge when cleaning the interior and exterior of the refrigerator.
- Do not place your hand on the bottom surface of the refrigerator when opening and closing.



WARNING

Use non-flammable cleaner. Failure to do so can result in fire, explosion, or death.

Inside Walls (allow freezer to warm up so the cloth will not stick)

To help remove odors, you can wash the inside of the refrigerator with a mixture of baking soda and warm water. Mix 2 tablespoons of baking soda to 1 quart of water (26 g soda to 1 liter water) Be sure the baking soda is completely dissolved so it does not scratch the surfaces of the refrigerator.

Door Liners and Gaskets

Use a clean sponge or soft cloth and a mild detergent in warm water. Do not use cleaning waxes, concentrated detergents, bleaches, or cleaners containing petroleum on plastic refrigerator parts.

Plastic Parts (covers and panels)

Use a clean sponge or soft cloth and a mild detergent in warm water. Do not use glass cleaners, abrasive cleansers, or flammable fluids. These can scratch or damage the material.

Condenser Coils

Use a vacuum cleaner with an attachment to clean the condenser cover and vents. Do not remove the panel covering the condenser coil area.

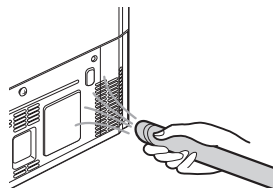

Replacing the Fresh Air Filter

Replace the air filter:

- Approximately every six months.
- When the Fresh Filter LED blinks or the Replace Filter icon is displayed.

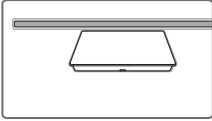

1 Remove the old filter.

Remove the cover to the air filter compartment. The air filter is on the inside of the cover. Press outward on the sides of the central compartment to release the tabs of the air filter. Remove the air filter.

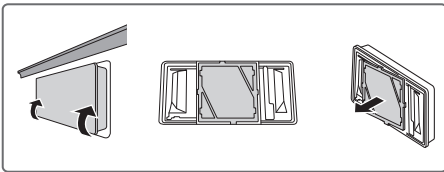

2 Install a new air filter.

Insert the side tab of the new filter into the slot on the side of the central cover compartment. Snap the other side of the filter down into place. It may help to press the side of the central compartment outward while pressing down on the filter. Make sure the side of the filter labeled "Back" is facing out. Snap the cover of the filter back onto the filter compartment in the refrigerator.

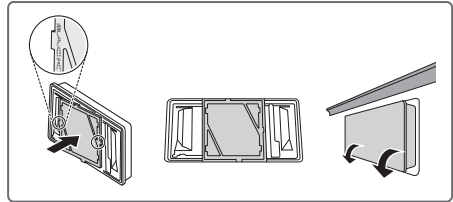

After changing the filter, push and hold the Fresh Filter button for three seconds to reset the filter sensor.

Replacing the Water Filter

NOTE

This refrigerator does not require a filter bypass plug when the filter is not in place.

Replace the water filter:

- Approximately every six months.
- When the water filter indicator blinks.
- When the water dispenser output decreases.
- When the ice cubes are smaller than normal.

1 Remove the old water filter.

Lift up and remove the lower door bin. Swing the right end of the water filter out of the compartment and then grasp and rotate the filter counterclockwise to remove it from the filter head.

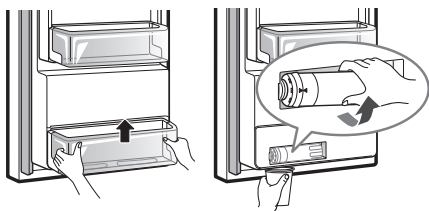

NOTE

Replacing the water filter could cause a small amount of water to drain. Place a cup under the filter head to catch any water.

2 Replace with a new water filter.

Insert the new filter into the filter head and rotate it clockwise until the arrow on the new filter lines up with the arrow on the filter head. Swing the filter back into the compartment.

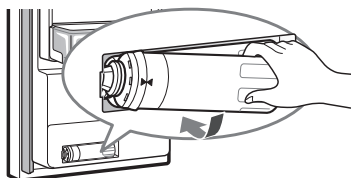

3 Assemble the door bin.

After changing the filter, push and hold the Water Filter button for three seconds to reset the filter.

