

# MANUAL INSTRUCTION

**Metal Garden Shed 3' X5' FT  
G37016**

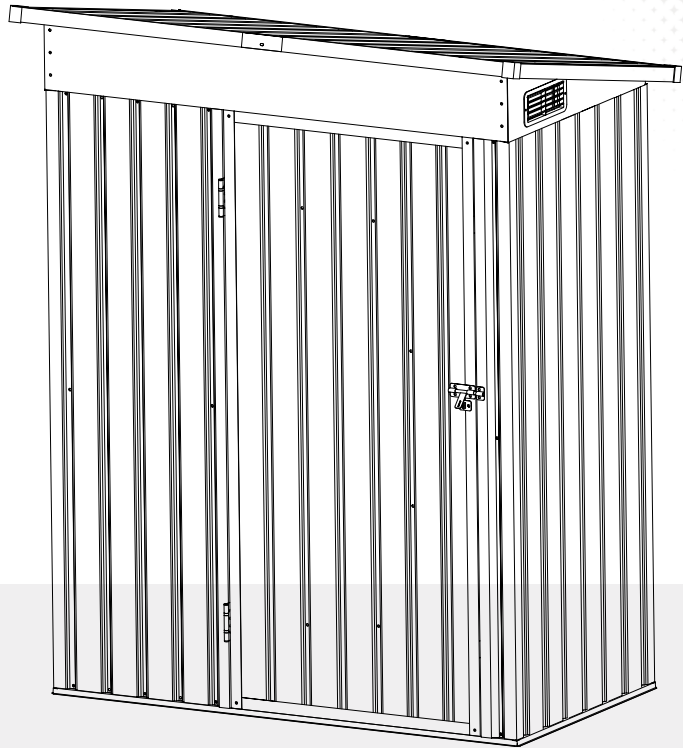

We offer a diverse range of products to meet the needs of customers.

## **Outdoor Furniture**

---

We are a professional furniture provider with top-notch factories and outstanding designs, Our mission is to provide consumers with new lifestyles. By collecting consumer feedback, we constantly improve our products and create more choices for consumers. If you want to create your space, We are an ideal choice.

---

Always.

---

## Thank you for your purchase our product.

1. If there is any damage, please kindly send clear photos of damaged parts to us as attachment, we will check and offer you best solution soon.
2. We attach great importance to the customer experience of our products. If there's any concern, please contact us at any time, we will provide effective solutions.
3. It is recommended to finish assembling by more than two people, so that it will be easier and also save your time.

## Attention

Please read this instruction carefully before installation and strictly follow it during installation. Ensure that there will be no problems in the future due to installation errors.

## Installation Notes

Please check the quantity of all parts before installation (Please refer to the Parts Lists) and the appearance of the products. Please make sure the product is correct before installation. If there is any problem, please contact us directly.

Make sure the colored panels are facing outwards and all the holes match. The panels are textured, please install the panels in the order specified in the instructions. All lines and holes must be accurately matched to make the storage shed more stable. Please ensure that all screws are tightened to prevent the product from falling apart.

There is a protective film on the surface to protect the product, please tear it off after installation to get the final presentation. If you do not damage the film during installation, it can also remain on the product to protect the product.

Please place the product on a flat ground to prevent leaning and collapse. If the ground is uneven, the door may can't be closed.

## Safety Precautions

1. We recommend two adults to complete the installation. Two adults installed together will make the installation process easier and safer.
  2. The gloves must be carried to prevent hand cuts during installation.
  3. Take care when using power tools near water the use of a residual current device (RCD) is advised.
  4. Please use the electric driver carefully during screwing to prevent the screw from slipping and hurting your hand. (We recommend that beginners use a manual screwdriver for installation.)
3. Be careful not to fall when installing the roof. Please steady the ladder and make sure the product placed on a flat ground.

## WARNING

- For your safety concern, please do not stand under the metal shed in heavy wind or snow days.
- For safety, please use expansion screws to reinforce the posts to the ground.
- In extreme weather conditions, you can use a rope to pull the four corners of the gazebo to keep it stable.
- Please clear the snow off the roof in time for the heavy snowfall. Make sure all screws are tightened before use.
- Repeat to confirm all screws, buckles and straps every 90 days. Please keep all screws loose during the assembly process and tighten them after completing the installation.
- Do not use or store objects in the Metal Shed with open flames or flammable chemicals.
- Please note that some parts have sharp edges and should be handled with gloves.
- If any parts are missing, broken, damaged or worn, discontinue use of the product until repairs are made or factory replacement parts are installed.
- Installation of the product in a manner that does not conform to the manufacturer's instructions may result in the loss of the warranty policy for this product.

## CALIFORNIA PROPOSITION 65

WARNING: This product can expose you to Carbon monoxide, which is known to the State of California to cause birth defects or other reproductive harm. For more information go to [www.P65Warnings.ca.gov](http://www.P65Warnings.ca.gov)

## PARTS

Before installation, please place the parts in the position as shown in the figure below.

### Shed top panels

NO.	QTY.
K34-8	2
K34-8M	1
K34-8MM	1
K34-10	2
K34-9	2
GC	4

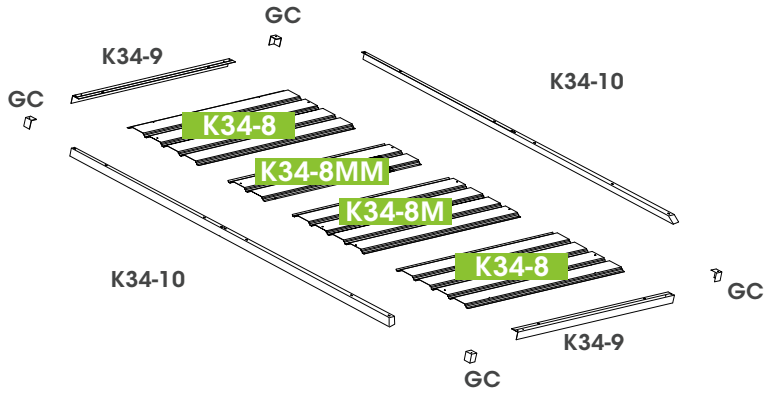

### Shed top panels

NO.	QTY.
K34-3	2
K34-6L	1
K34-6R	1
K34-7	1
K34-4	1
K34-5	1
C2	4
GF	2

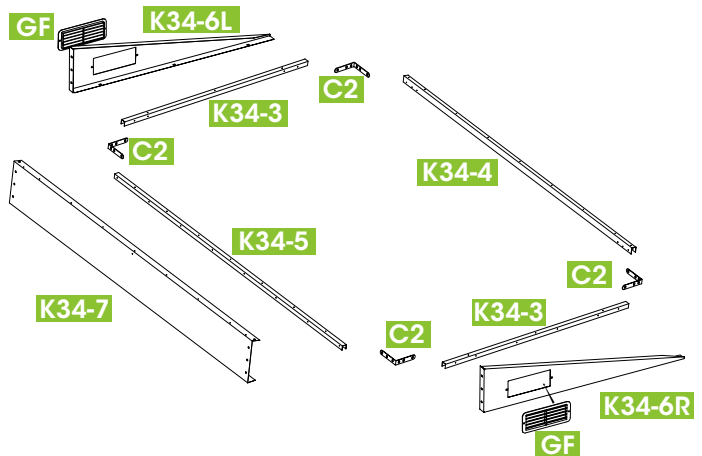

## PARTS

Before installation, please place the parts in the position as shown in the figure below.

### Shed top panels

NO.	QTY.		
W5	4	K34-1	2
W5-C	4	K34-2	2
W5-X	1	T-F	4
W3-HX	1		
URA	1		
ULA	1		
DRA1	1		
DD	2		
DX1	1		
DLA1	1 </td <td></td> <td></td>		

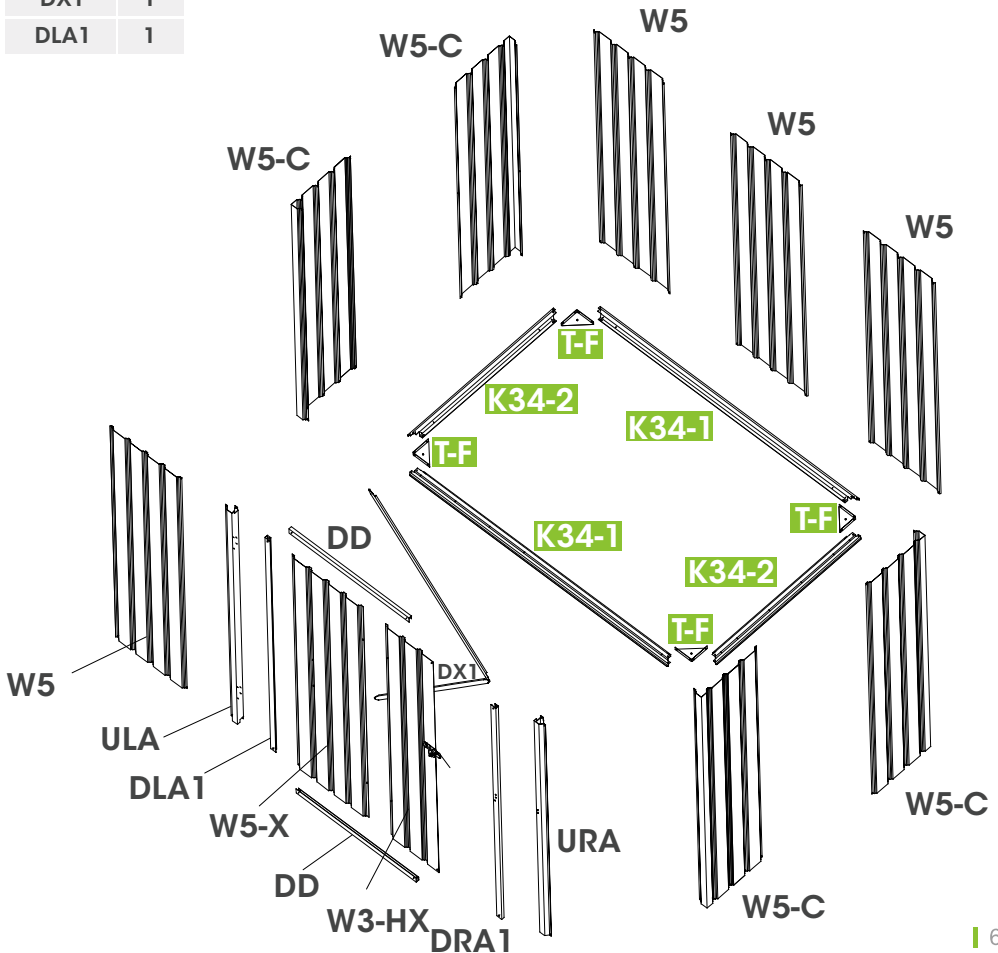

## PARTS

Before installation, please place the parts in the position as shown in the figure below.

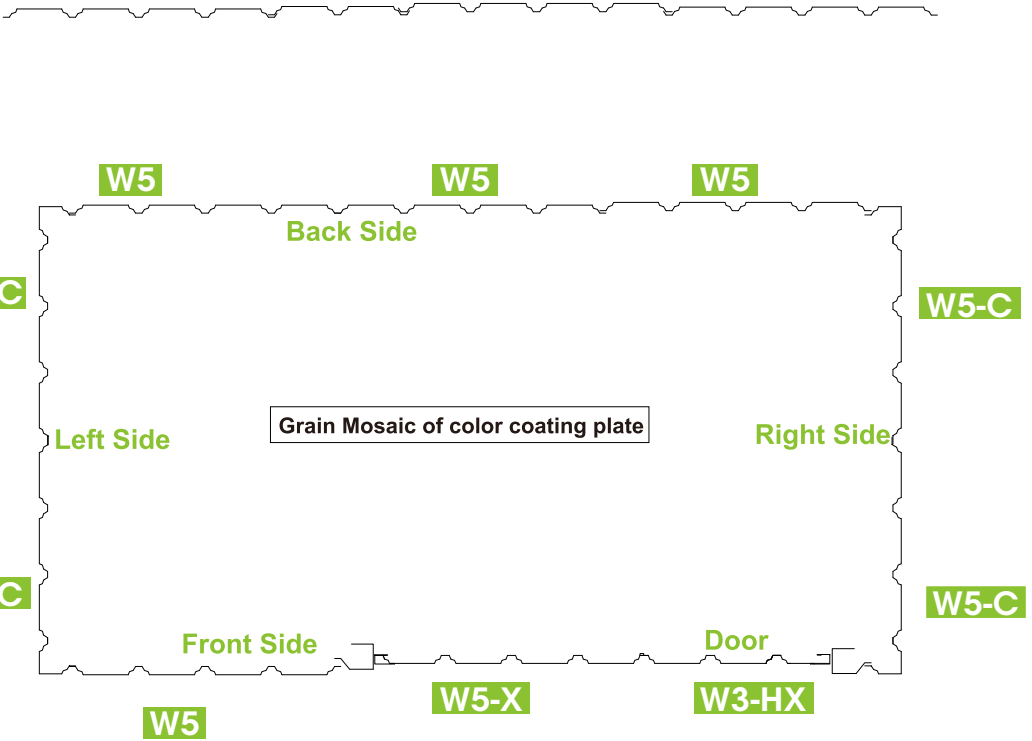

# TOOLS REQUIRED



Electric  
Screwdriver



+Manual  
Screwdriver



Ladder



2-4 Persons Assembly



Up to 120 Minutes For Assembly

## PACKAGE C PART LIST

K34-1



2PCS

K34-2

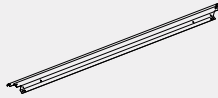

2PCS

K34-3



2PCS

K34-4



1PCS

K34-5



1PCS

ULA



1PCS

URA



1PCS

K34-6L

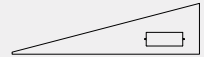

1PCS

K34-6R

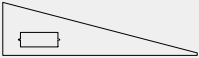

1PCS

K34-7

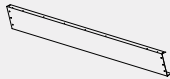

1PCS

K34-9



2PCS

K34-10



2PCS

DX1

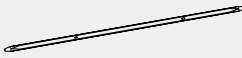

2PCS

DD



2PCS

DLA1



1PCS









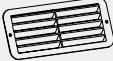

DRA1









1PCS



## PACKAGE C PART LIST

<p><b>GC</b></p>  <p>4PCS</p>	<p><b>GF</b></p>  <p>2PCS</p>	<p><b>T-F</b></p>  <p>4PCS</p>	<p><b>F1</b></p>  <p>173PCS</p>
<p><b>V2</b></p>  <p>54PCS</p>	<p><b>F2</b></p>  <p>33PCS</p>	<p><b>F3</b></p>  <p>16PCS</p>	<p><b>DCS</b></p>  <p>1PCS</p>
<p><b>C2</b></p>  <p>4PCS</p>	<p><b>DH</b></p>  <p>2PCS</p>	<p><b>SL</b></p>  <p>38PCS</p>	<p><b>M4</b></p>  <p>1PCS</p>
<p><b>ST</b></p>  <p>2PCS</p>			

## PACKAGE AB PART LIST

<p><b>W5-X</b></p>  <p>1PCS</p>	<p><b>W3-HX</b></p>  <p>1CS</p>	<p><b>W5-C</b></p>  <p>4PCS</p>	<p><b>W5</b></p>  <p>4PCS</p>
<p><b>K34-8</b></p>  <p>2PCS</p>	<p><b>K34-M</b></p>  <p>1PCS</p>	<p><b>K34-8MM</b></p>  <p>1PCS</p>	

# PRODUCT ASSEMBLY

**1**

## STEP1: Shed Base Frame Assemble

Link the two "K34-1" and "K34-2" to each other, and reinforce the four corners with "T-F".

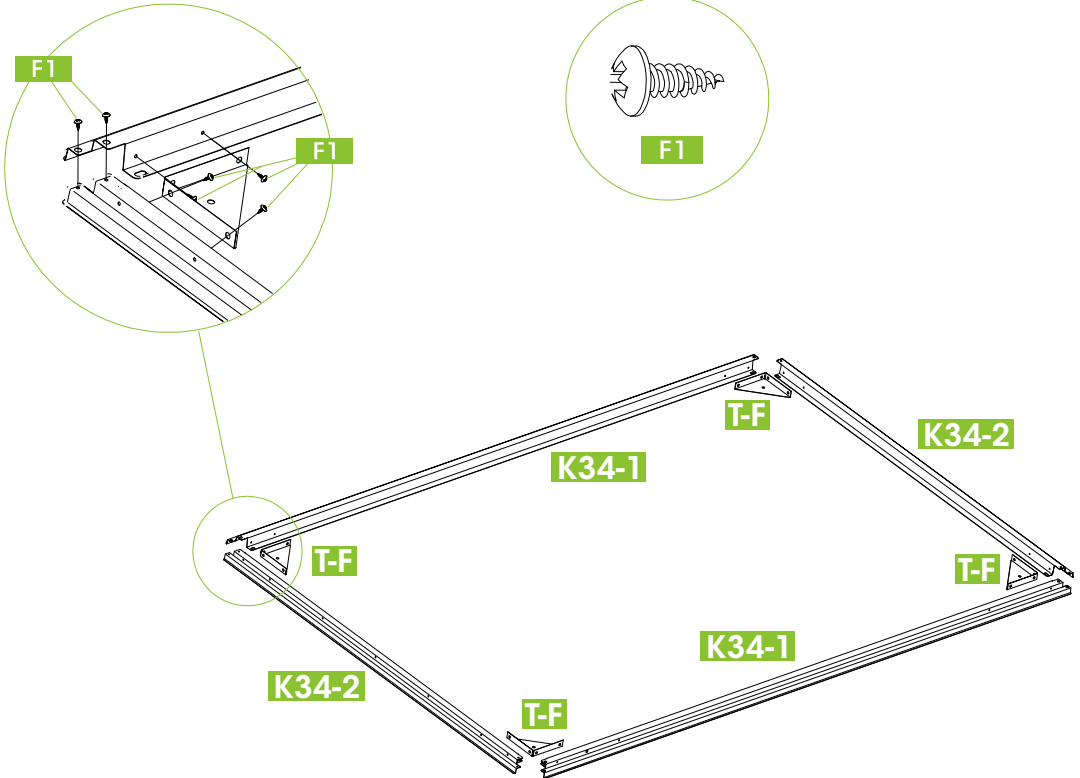

PART	NO.	QTY.
	K34-1	2
	K34-2	2
	T-F	4
	F1	24





Note: The larger hole is always covered over the small hole.

# PRODUCT ASSEMBLY

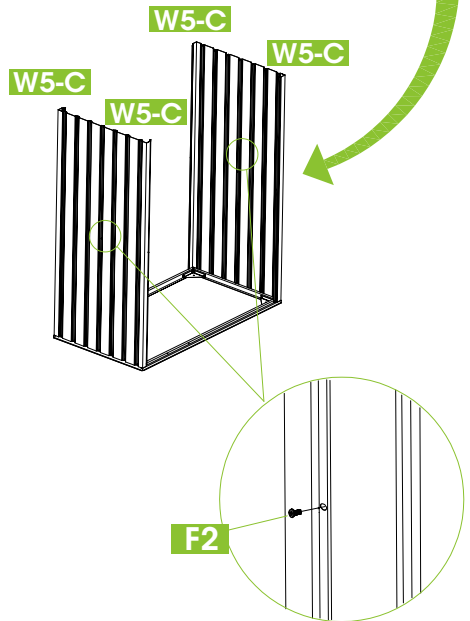
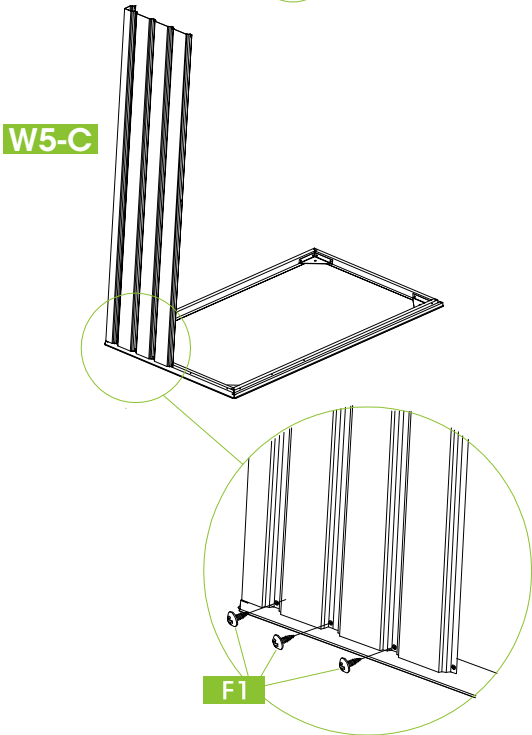
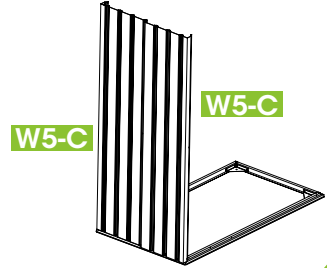
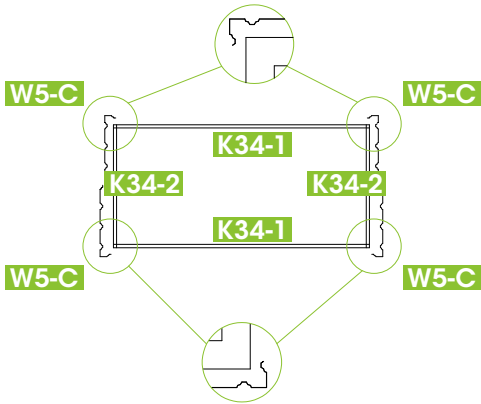
**2** STEP2: Shed Side Panels Assemble  
Mount the 4 "W5-C" on the Shed Base Frame Assemble as shown.



PART	NO.	QTY.
	W5-C	4
	F1	14
	F2	2

# PRODUCT ASSEMBLY

**3** STEP3: Install two "K34-3" on "W5-C" as shown

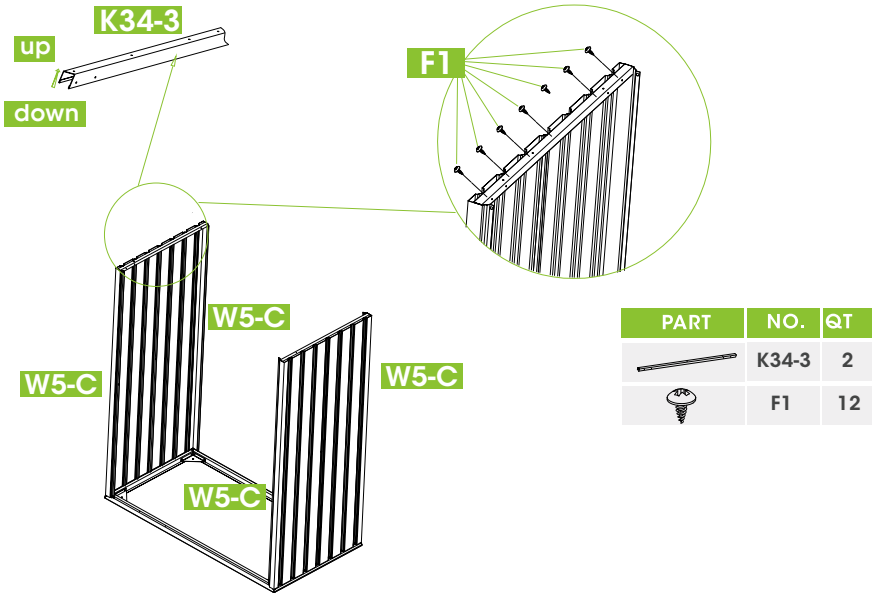



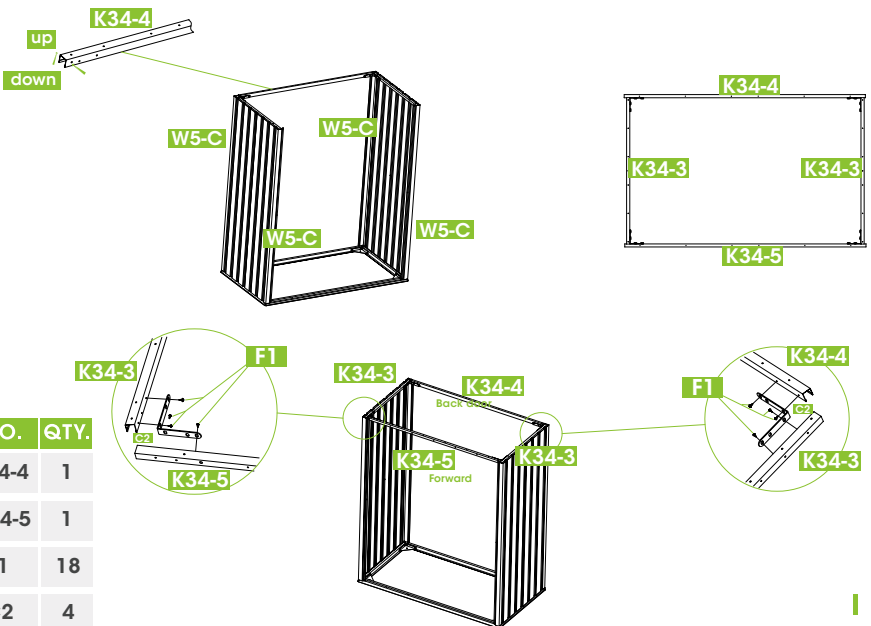

**4** STEP4: Link "K34-4" and "K34-5" with "K34-3" using 4 "C2"

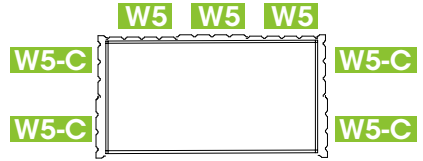
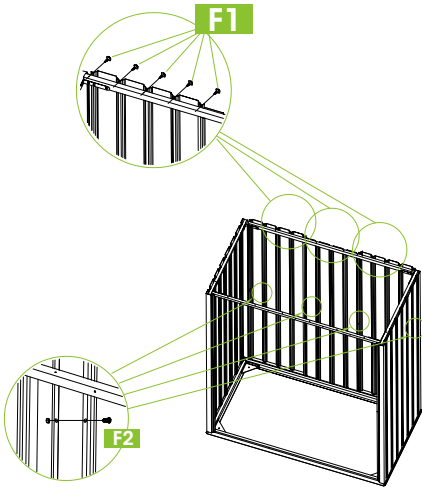

# PRODUCT ASSEMBLY



**5** STEP5: Install three "W5" on "K35-4"

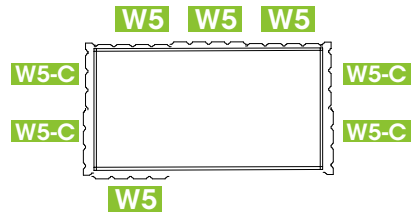
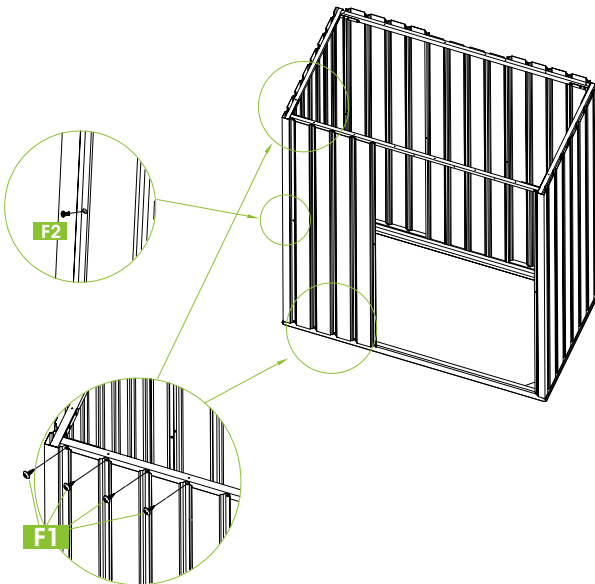

PART	NO.	QTY.
	W5	2
	F1	26
	F2	4

**6** STEP6: Install the remaining "W5" according to the diagram.





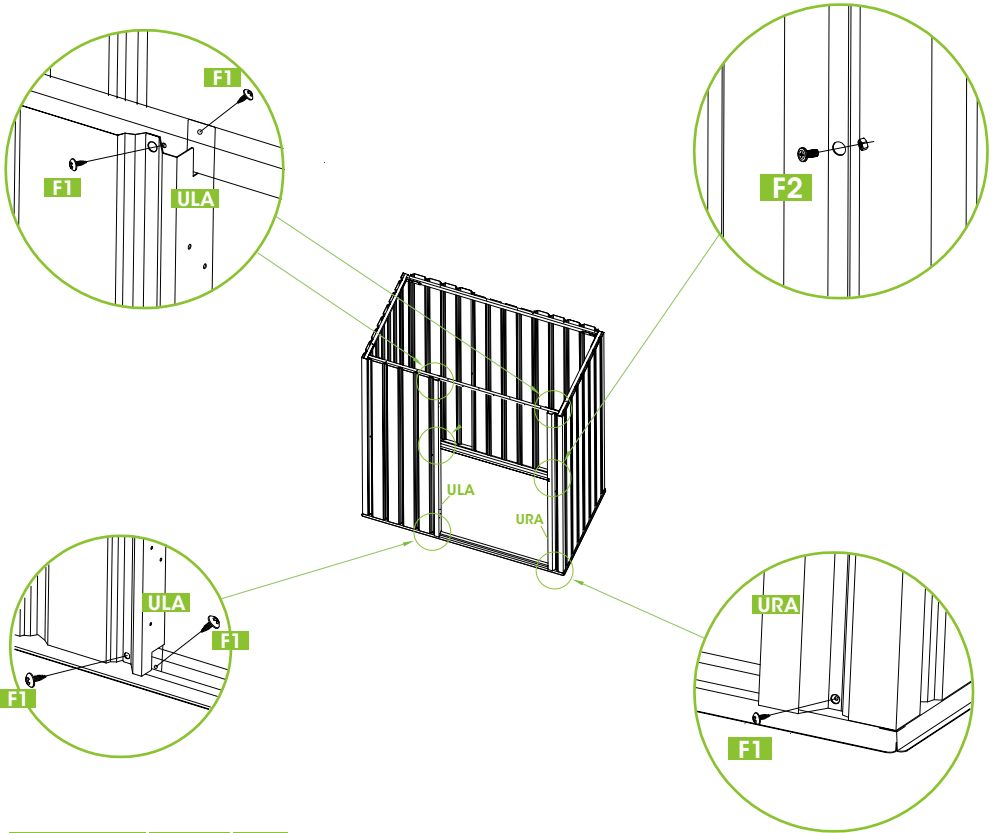

PART	NO.	QTY.
	W5	1
	F1	8
	F2	1

# PRODUCT ASSEMBLY

**7** STEP7: Install "ULA" on the left side of the door frame and "URA" on the right side of the door frame.



PART	NO.	QTY.
	ULA	1
	URA	1
	F2	8
	F1	2

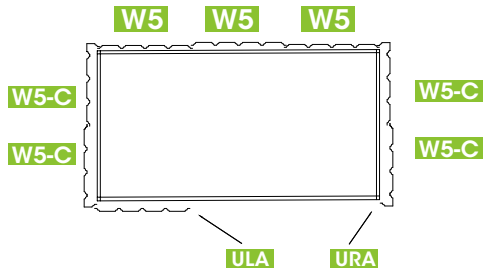

# PRODUCT ASSEMBLY

**8** STEP8:1.Install the "GF" window in the position shown in the figure.  
2.Shed Top Frame Assemble "K34-6L" is mounted on the top left  
"K34-6R" is mounted on the top right

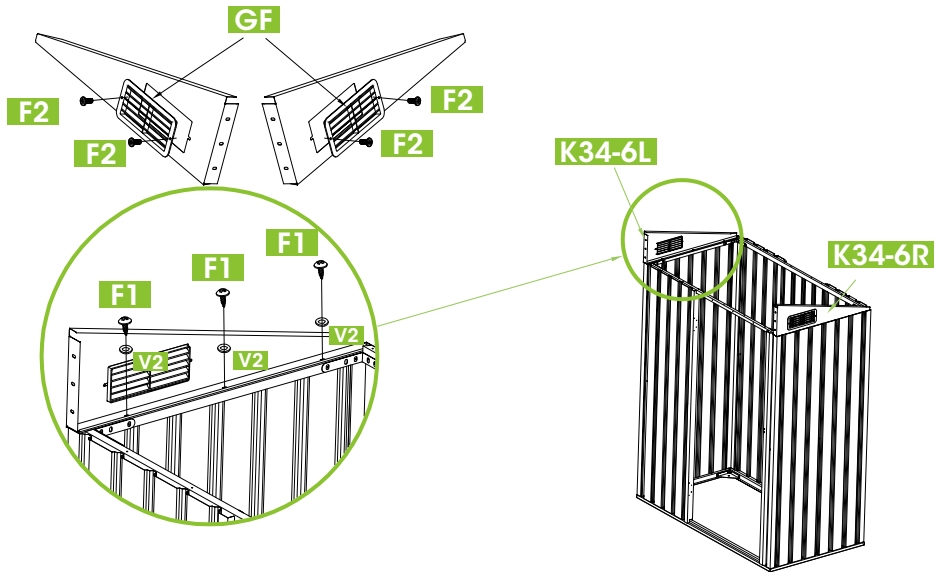

**9** STEP9:Install the "k34-7" on top of the front

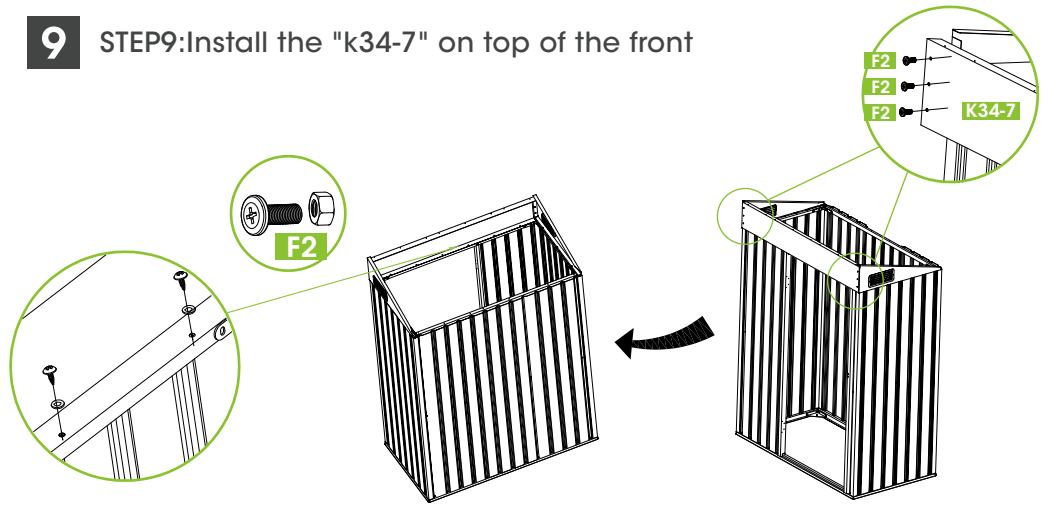



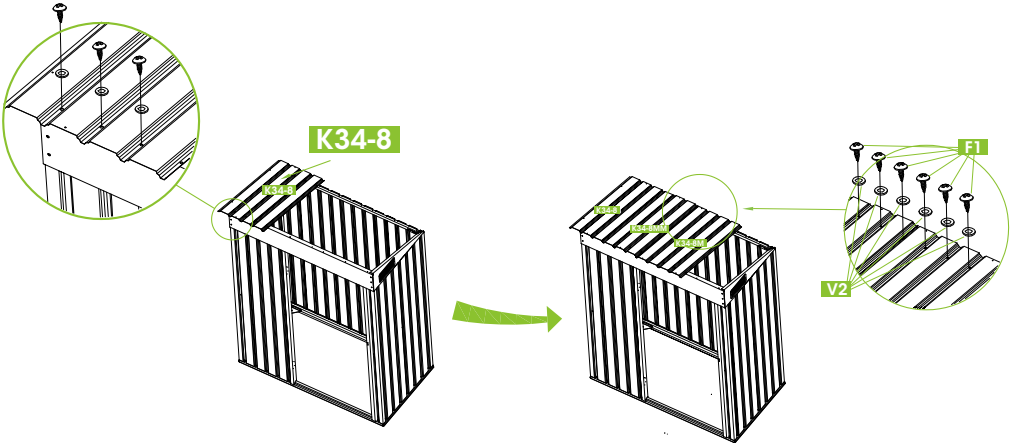

PART	NO.	QTY.						
	K34-6L	1		GF	2		F1	12
	K34-6R	1		F2	10			
	K34-7	1		V2	12			

# PRODUCT ASSEMBLY

**10** STEP10: Shed Top Panels Assemble "K34-8" is mounted on the top left and top right.



**11** STEP11: Install the remaining two "K34-8MM" and "K34-8M" in the ceiling void.

PART	NO.	QTY.
	K34-8	2
	K34-8M	1
	K34-8MM	1
	V2	26
	F1	26

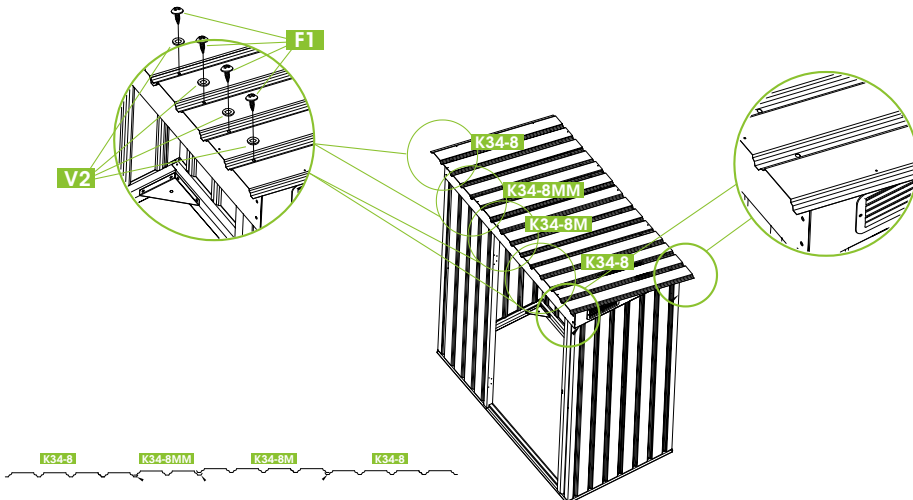



# PRODUCT ASSEMBLY

**12**

- STEP12:1 .Install hemming "K34-9" on both sides of the roof.  
 2.Connect and install K34-10 on the rear side of the roof.  
 3.Connect and install K34-10 on the front side of the roof  
 4.Install the corner "GC" on the four corners of the roof.t

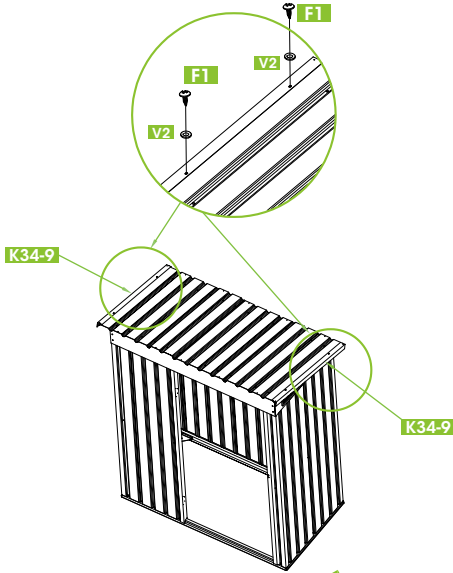



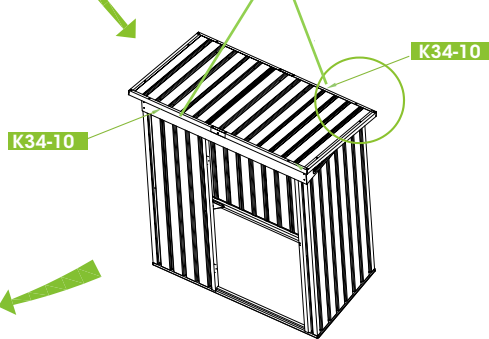
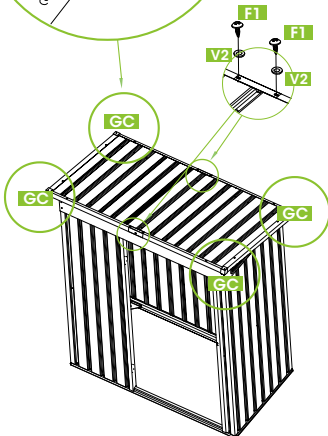
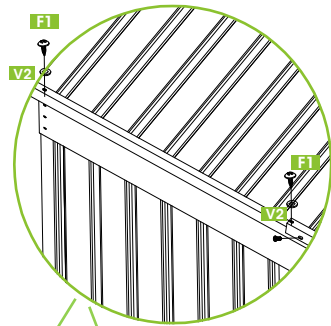
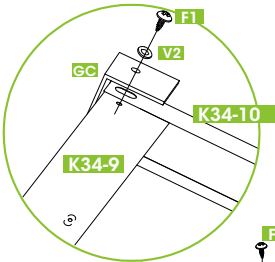





PART	NO.	QTY.
	K34-9	2
	K34-10	2
	V2	16
	F1	16
	GC	4
	F2	2





# PRODUCT ASSEMBLY Door Assemble

**13**

- STEP13:1.Assemble "W5-X" and "W3-HX" together using "F2"  
 2.Install "DD""DLA1" and "DRA1" around the door.  
 3.Install "DX1" on the inside of the door for reinforcement  
 as shown in the figure.

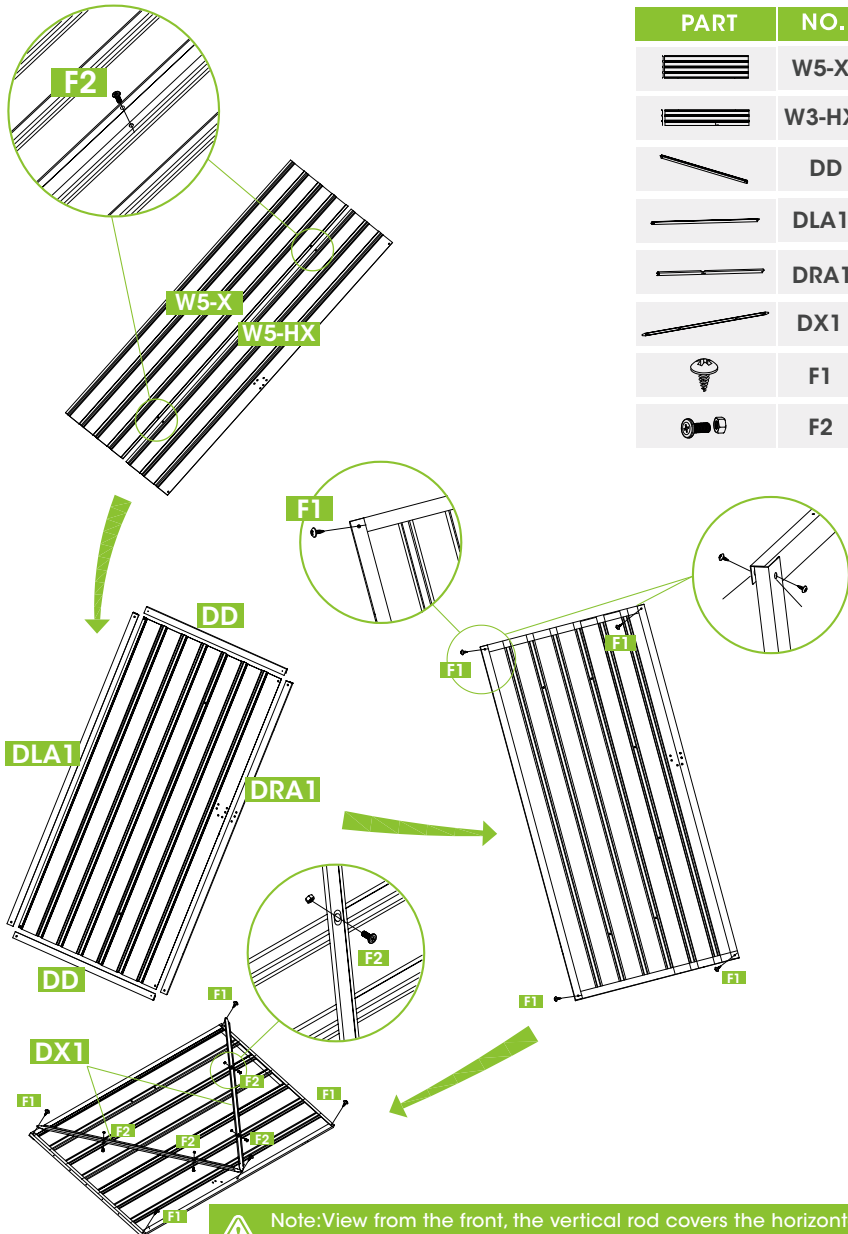
PART	NO.	QT
	W5-X	1
	W3-HX	1
	DD	2
	DLA1	1
	DRA1	1
	DX1	2
	F1	9
	F2	6







 Note:View from the front, the vertical rod covers the horizontal rod.The larger hole is always covered over the small hole.

# PRODUCT ASSEMBLY

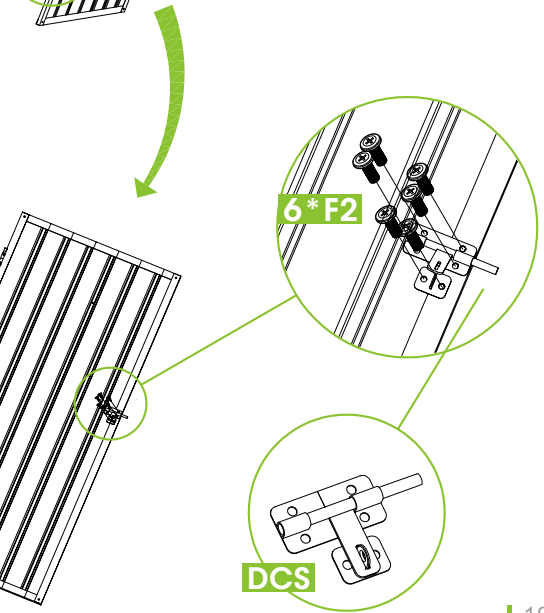
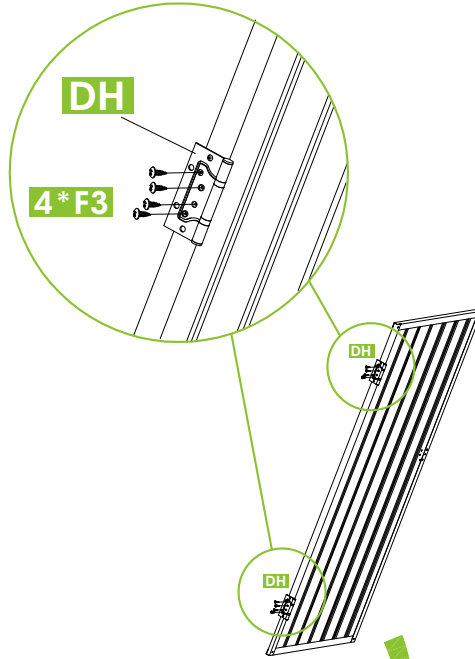
14

- STEP14:1 .Install the two "DH" hinges on one side of the door using 8 "F3" screws  
 2.Use 6 "F2" screws to fasten the "DCS" part to the door as shown  
 STEP15:1 .Use 8 "F3" screws to mount the door in the position shown  
 3.Use 2 "F2" screws to mount the "DCS" part in the position shown





PART	NO.	QT
	DCS	1
	DH	2
	F3	8
	F2	6

# PRODUCT ASSEMBLY

15

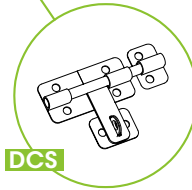
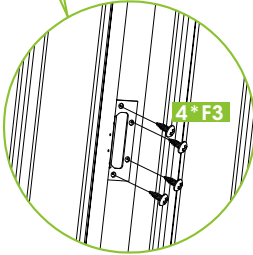
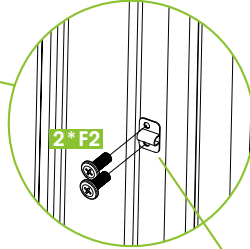
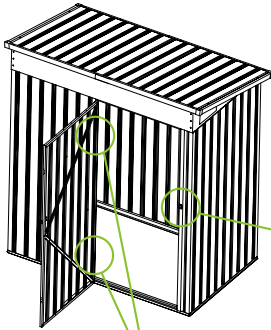
STEP15: The exposed parts of the screws need to be covered with plastic protective caps. Screw positions: Exposed parts of ceiling and k34-7 assembly screws.



PART	NO.	QT
	F3	8
	F2	2

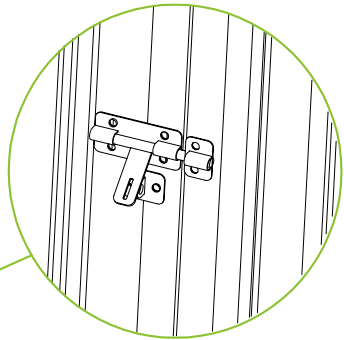
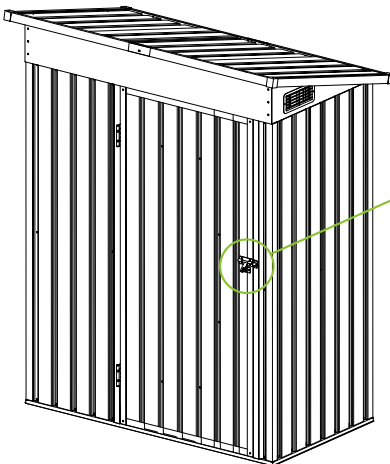

# PRODUCT ASSEMBLY

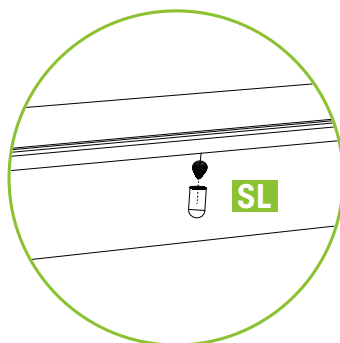
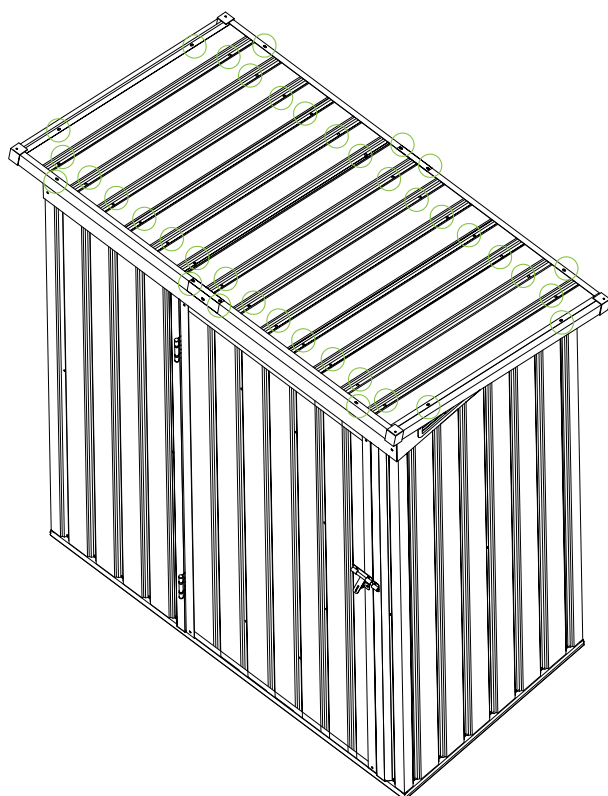

PART	NO.	QT
	SL	38

# HELP CENTER

Question about your product? We're here to help. Visit us at:

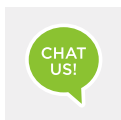

Chat Support

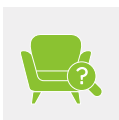

Product Inquiry

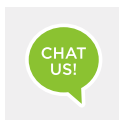

Orders FAQ



Product Assembly



Returns & Refunds

## We Stand Behind the Quality of Their Furniture

If you have any issues with your item please let us know! We will always do our best to come up with a solution that you will be happy with.

Please get in touch with our customer service team before returning the product.

And pls do not throw the original box(es) if you have not finished assembling or confirmed no quality issues.

Length of return period:

Items can be returned within 30 days of purchase.

In the meanwhile, everything you purchased from us comes with a one-year warranty.

Who is responsible for the return shipping fee:

We will cover the return shipping fees if:

1. Your item has a manufacturing defect in its materials or workmanship. For example, torn wicker or misaligned screw holes. We will send you a prepaid shipping label after photos are sent.
2. Your item has been damaged in transit. For example, glass is broken or wicker is damaged. We will send you a prepaid shipping label after photos are sent.
3. You receive the wrong box(es) due to a warehouse error. We will send you a prepaid shipping label after photos are sent of the wrong SKU numbers on the outer box(es).
4. One or more boxes are lost in transit. We will send you a prepaid shipping label if you no longer want the item.

\*However, we still hope to work with you for a better solution instead of a return. Please don't hesitate to contact our customer service team.

Customer will cover the return shipping fees if:

1. You don't like the product(s) after receiving the box(es).
2. You no longer need the product(s) but you have received the box(es).
3. You buy the product(s) by mistake but you have received the box(es).
4. Order/Shipment cancellation failed and you have received the box(es).

---

## Return Request

In order to get a full refund as described in this return policy, all items must be: (1) In a brand new/unused condition, please provide photos before and after packaging. (2) When returning, all accessories and parts are firmly packed in all original packaging.

If your return does not meet the requirements, you may not get a full refund.

When will I be refunded?

The refund is released once the goods have been returned to our warehouse.

What if the product is damaged/defective outside of the valid return period?

We want you to be a happy customer. Please reach out to us by email and we will come up with a solution to make sure you are satisfied.