

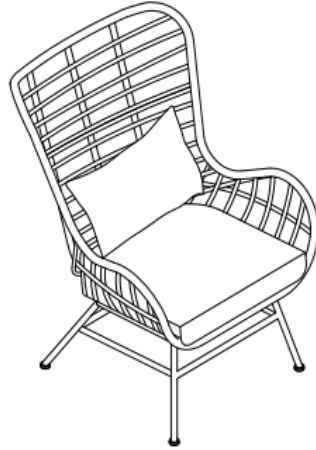

# Assembly Instructions

Caution: You must read this before you proceed

## Chair

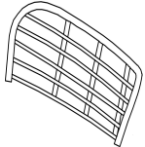
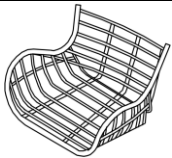
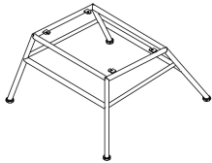
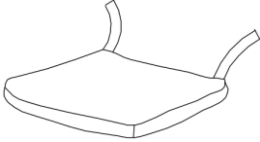

### Part List

Label	Picture	Description	QTY
A		Backrest	1
B		Seat	1
C		Chair Legs	1
D		Seat Cushion	1
E		Back cushion	1

## Hardware

Label	Picture	Description	QTY
①		Bolt (M6X20mm)	5
②		Bolt (M6X40mm)	4
③		Allen Key	1
④		Washer	11
⑤		Spring Washer	11
⑥		Cap	8
⑦		Nut	4
⑧		Open ended wrench	1
⑨		Cap	4

## Assembly Preparation

Before Beginning Assembly:

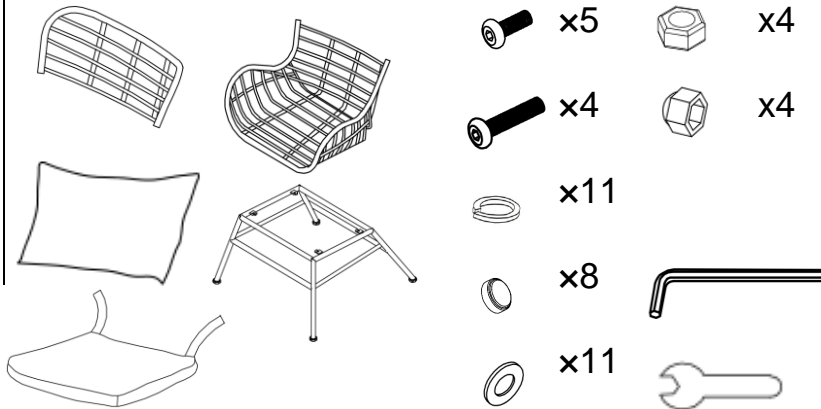

- Read instructions, cover to cover-



- Have 2 adults on hand for assembly-



- Do not assemble on flooring or carpet-



- Assemble on a clean non-marring surface (packing foam)-



- Save all packaging until finished-

# Assembly Steps

## Overview

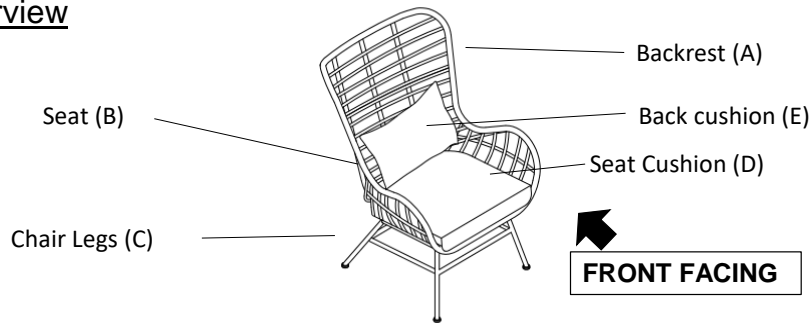

This Chair has multiple parts and may require up to 30 minutes to assemble. To give you an overview of the Chair parts, the above picture is to help you put the various parts into perspective. Please read through the instructions below to familiarise yourself with the parts and steps before assembly.

## Step 1

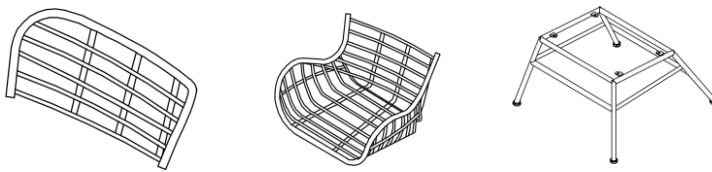

Unpack and place all parts on a clean, non-marring surface.

## Step 2

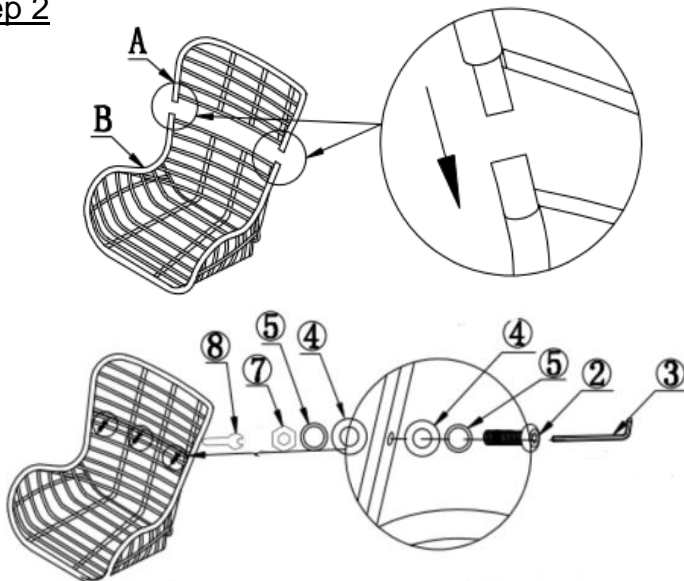

Place the Seat(B) face up onto a clean, non-marring surface.

Align the Seat(B) to the Backrest(A) as shown above.

Attach the Seat(B) to the Backrest(A) using Bolts(2), Spring Washers(5), Washers(4) and a Nut (7) with an Allen Key(3) and an Open ended wrench (8) .

**Do not fully tighten the Bolts.**

### Step 3

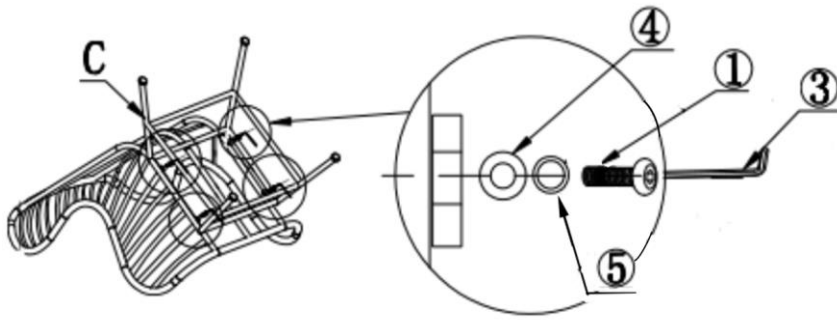

Place the Seat(B) facedown.  
Align the Seat(B) to the Chair Legs(C) as shown above.  
Attach the Seat(B) to the Chair Legs(C) using Bolts(1), Spring Washers(5) and Washers(4) with an Allen Key(3).  
**Note: The front Legs are high and the back low.**  
**Do not fully tighten the Bolts.**

### Step 4



Stand the Chair up.  
Exert pressure floorwards, onto the Chair with both your hands.  
This pressure will help the Legs and Seat reach full alignment status.  
Check for wobbles on a LEVEL surface.  
If no wobbles are found proceed to tighten the Bolts in a sequential manner, until evenly secured.  
**When tightening the Bolts tighten sequentially.**  
**Do not tighten any Bolt fully and then move on towards the next one.**  
**If there are still wobbles after tightening, loosen the Bolts and execute the same above process.**

### Step 5

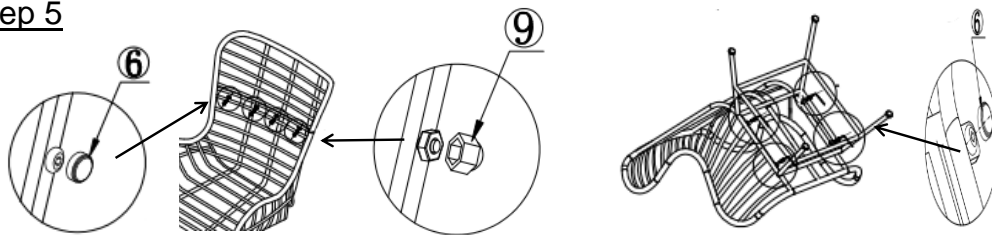

Cover the Bolts(1) and Bolts(2) using Caps(6).

## Step 6

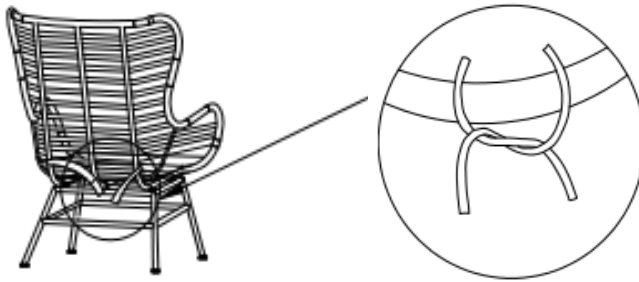





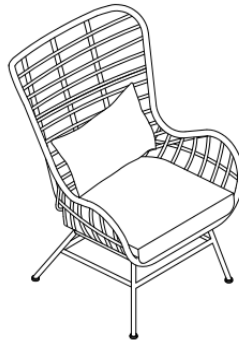















Stand the Chair up.  
Put the Seat Cushion(D) onto the Chair.  
Secure the Seat Cushion using the Velcro straps as pictured.

## Step 7



Place the Back Cushion(E) on the Chair.  
Your Chair is ready for use.  
**This Chair can only be used on a flat and level surface.**

## Care & Maintenance

-   ● Do not put hot items directly on furniture surface
-   ● Do not clean furniture with harsh cleansers or polish.
-   ● To obtain the longest lifespan of your outdoor products, minimizing exposure to direct sunlight is recommended.
-   ● Children should not climb or jump on the furniture.
-   ● Do not write on furniture without a padded barrier to protect the surface.
-   ● To obtain the longest lifespan of your outdoor products, avoid extended and lengthy exposure to rain, snow, and direct sunshine. Whenever possible cover the product and /or place under patio or awnings.
-   ● Not for commercial use. For residential use only .
-   ● Stains may be removed with mild soap solution and damp cloth.
-   ● Keep away from sources of ignition.
-   ● Dust and pick-up spills using a clean, non-colored, lint-free cloth.