

BEAST

Electric Pressure Washer Owner's Manual

This Manual Contains Important Safety Instructions and Operating Instructions

Models: P1450B, P1750B, P1450B-CAN, P1500B, P1750B-CAN

P1600B, P1800B, P1600B-BB, P1800B-BB, P1600B-CAN, P1800B-CAN, P2000B-BB

Contents:

- Page 2 Factory Original Parts
- Page 3 Package Contents/Component Identification
- Page 5 Warnings
- Page 7 Preparation & Assembly - Model 1450B, 1450B-CAN, P1500B, P1600B, P1600B-BB, P1600B-CAN,
- Page 8 Preparation & Assembly - Model 1750B, 1750B-CAN P1800B, P1800B-BB, P1800B-CAN, P2000B-BB
- Page 9 Operation
- Page 13 Maintenance
- Page 14 Tips for Cleaning
- Page 14 Troubleshooting
- Page 16 Spare Parts List
- Page 17 Warranty
- Page 18 Extended Warranty & Product Registration Card

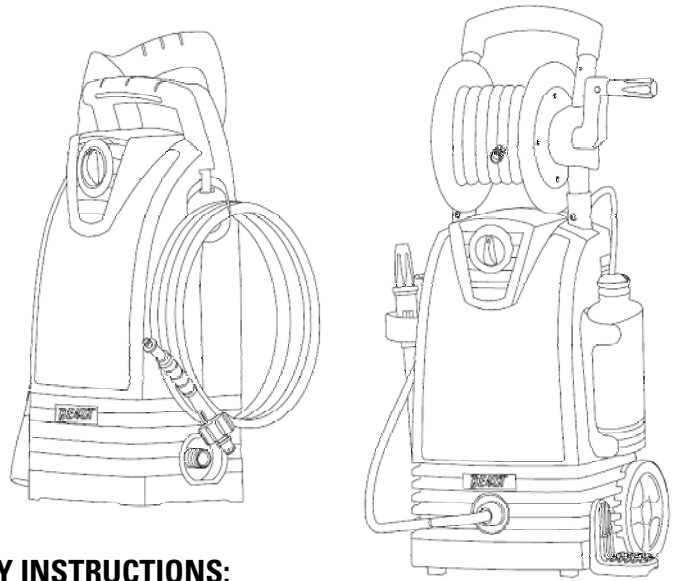

IMPORTANT SAFETY INSTRUCTIONS:

READ SAFETY WARNINGS AND OPERATING INSTRUCTIONS CAREFULLY

SAVE THESE INSTRUCTIONS



TO PREVENT PREMATURE WEAR ON PRESSURE WASHER PUMP, DO NOT ALLOW UNIT TO RUN MORE THAN 30 MINUTES AT A TIME

DO NOT RETURN UNIT TO THE STORE!

QUESTIONS OR NEED HELP?

Call: 919-550-3221

www.PressureWasher911.com

Have the following information ready when you call us:

Date of Purchase: _____

Location of Purchase: _____

Serial #: _____



Is a registered trademark of The Beast Works or its affiliates and is used under license by GXi Outdoor Power, LLC.

FACTORY ORIGINAL BEAST PARTS

ORDER ONLINE NOW AND SAVE!

www.PressureWasher911.com

Phone orders, call [1] 919-550-3221

Please have the part number and credit card ready when calling.



Replacement Gun

Part Number: SP01009

Price: \$30.00



Replacement Adjustable Wand

Part Number: SP00209 (Model P1450B, 1450B-CAN, P1500B, P1600B, P1600B-BB, P1600B-CAN)

Part Number: SP00309 (Model P1750B, 1750B-CAN, P1800B, P1800B-BB, P1800B-CAN, P2000B-BB)

Price: \$30.00



Replacement Turbo Wand

Part Number: SP00409

Price: \$30.00

SP00509



SP02412



Replacement High Pressure Hose

Part Number: SP00509 (Model P1450B, P1450B-CAN, P1500B, P1600B, P1600B-BB, P1600B-CAN)

Part Number: SP02412 (Model P1750B, P1750B-CAN, P1800B, P1800B-BB, P1800B-CAN, P2000B-BB)

Price: \$30.00

Rotary Brush



Straight Brush



Replacement Rotary and Straight Brush

Part Number: SP00709 (Rotary Brush)

Part Number: SP00809 (Straight Brush)

Price: \$30.00 Each

**For replacement parts not listed here,
see pages 3-4.**

PACKAGE CONTENTS (P1450B, P1450B-CAN, P1500B, P1600B, P1600B-BB, P1600B-CAN)

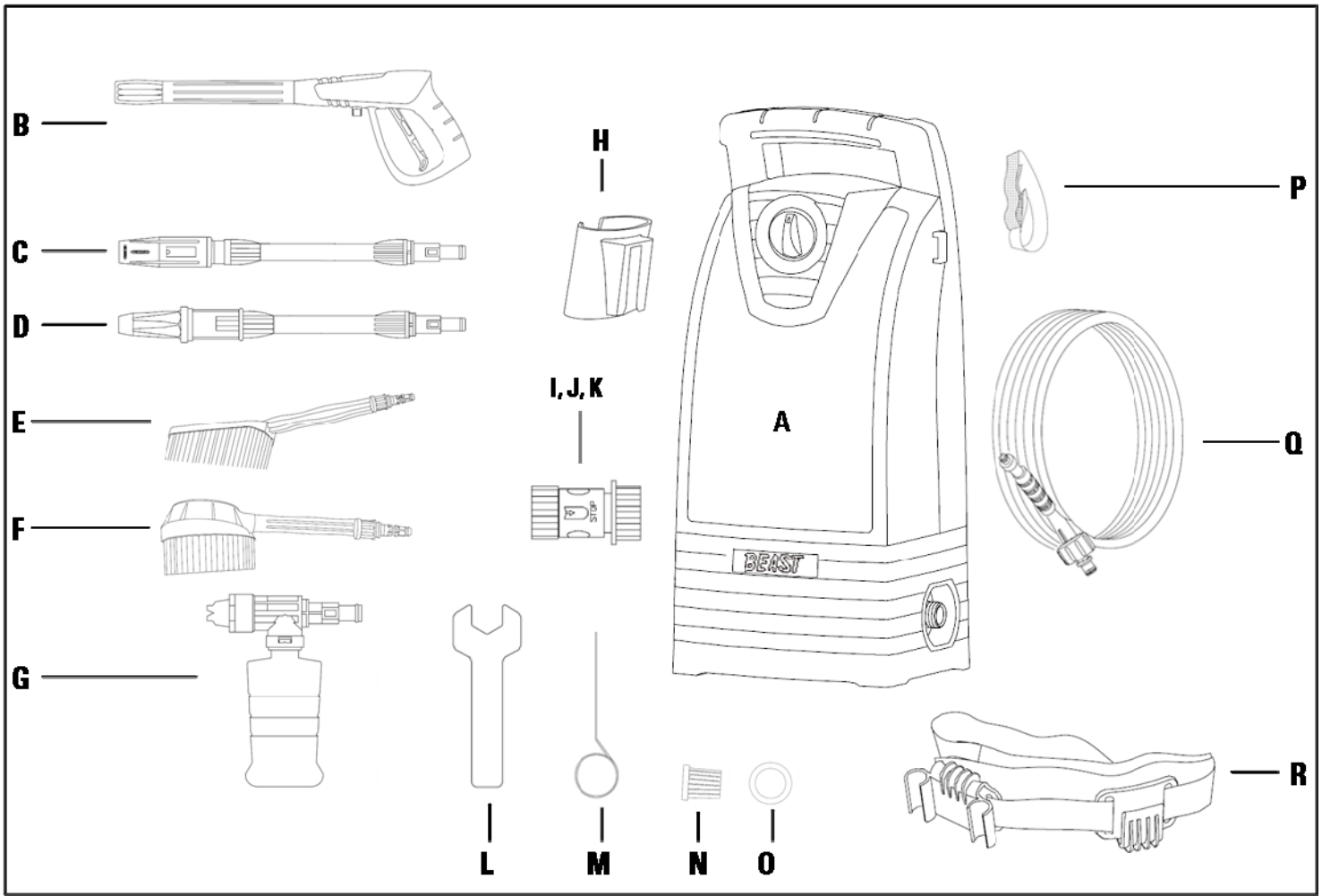

Note: Not all accessories are included with every model. Some accessories may be sold separately	Qty.*	P1450B	P1450B-CAN	P1600B	P1600B-BB	P1600B-CAN	P1500B
A: Main Unit	1	●	●	●	●	●	●
B: Spray Gun	1	●	●	●	●	●	●
C: High Pressure Adjustable Wand	1	●	●	●	●	●	●
D: Turbo Wand	1						
E: Straight Brush	1						
F: Rotary Brush	1						
G: Soap Injector	1	●	●	●	●	●	●
H: Gun Holder	1	●	●	●	●	●	●
I: Zinc Connect	1	●	●	●	●	●	●

* Standard quantity where applicable, not all products come standard with all features and/or accessories. See chart for standard features by model.

Note: Not all accessories are included with every model. Some accessories may be sold separately	Qty.*	P1450B	P1450B-CAN	P1600B	P1600B-BB	P1600B-CAN	P1500B
J: Plastic Quick Connect (2 pcs.)	1						
K: Brass Quick Connect (2 pcs.)	1						
L: 17mm Wrench	1	●	●	●	●	●	●
M: Cleaning Needle	1	●	●	●	●	●	●
N: Water Filter	2**	●	●	●	●	●	●
O: O-Ring	6	●	●	●	●	●	●
P: Hose Strap	1	●	●	●	●	●	●
Q: High Pressure Hose	1	●	●	●	●	●	●
R: Tool Belt	1						

** One filter comes in the machine water inlet, an extra is provided in the hardware bag.

PACKAGE CONTENTS (P1750B, P1750B-CAN, P1800B, P1800B-BB, P1800B-CAN P2000B-BB)

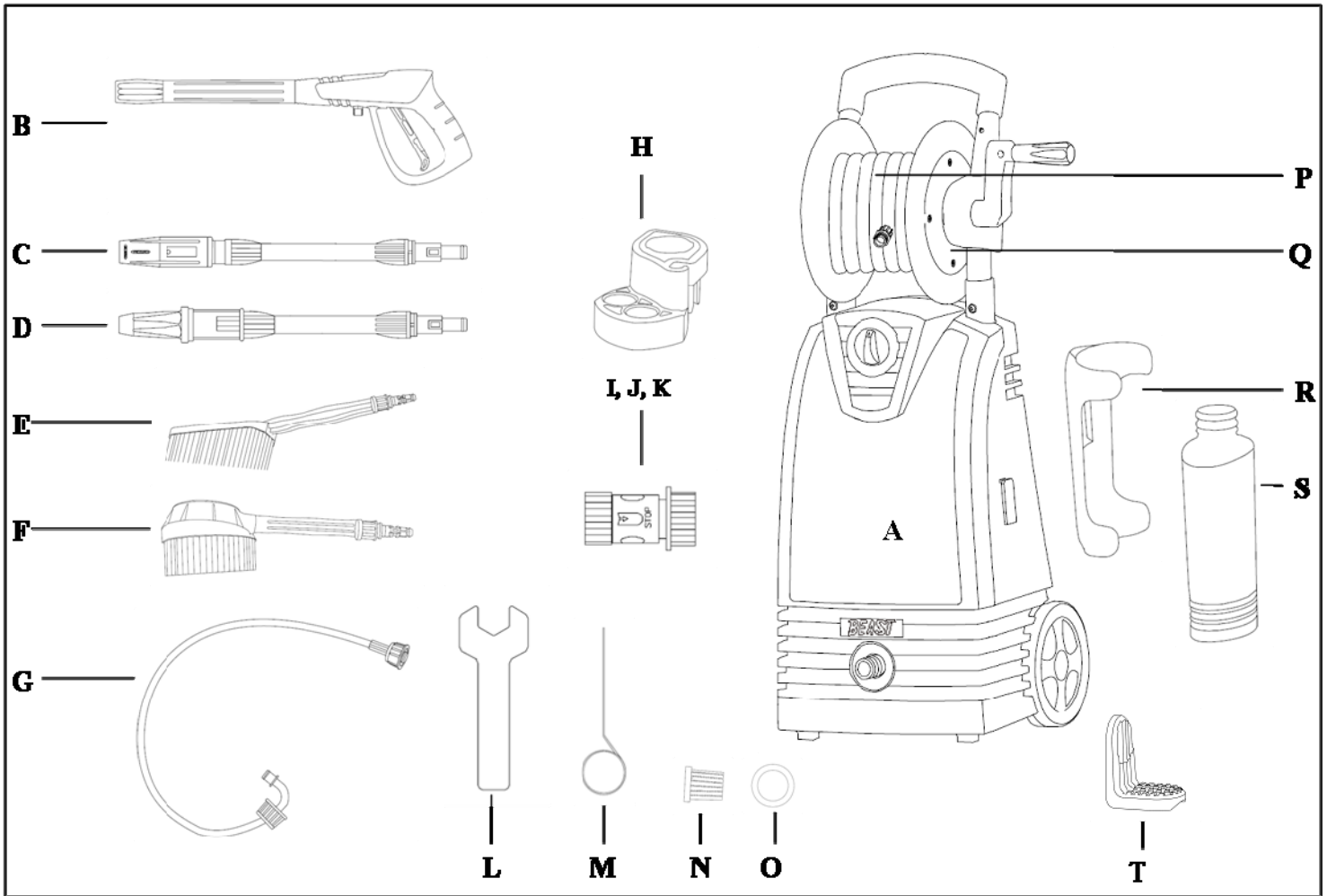

Note: Not all accessories are included with every model. Some accessories may be sold separately	Qty.*	P1750B	P1750B-CAN	P1800B	P1800B-BB	P1800B-CAN	P2000B-BB
A: Main Unit	1	●	●	●	●	●	●
B: Spray Gun	1	●	●	●	●	●	●
C: Adjustable Wand	1	●	●	●	●	●	●
D: Turbo Wand	1						
E: Straight Brush	1						
F: Rotary Brush	1						
G: Extension Hose	1	●	●	●	●	●	●
H: Gun Holder	1	●	●	●	●	●	●
I: Zinc Connect	1	●	●	●	●	●	●
J: Plastic Quick Connect (2 pcs.)	1						

* Standard quantity where applicable, not all products come standard with all features and/or accessories. See chart for standard features by model.

Note: Not all accessories are included with every model. Some accessories may be sold separately	Qty.*	P1750B	P1750B-CAN	P1800B	P1800B-BB	P1800B-CAN	P2000B-BB
K: Brass Quick Connect (2 pcs.)	1						
L: 17mm Wrench	1	●	●	●	●	●	●
M: Cleaning Needle	1	●	●	●	●	●	●
N: Water Filter	2**	●	●	●	●	●	●
O: O-Ring	6	●	●	●	●	●	●
P: High Pressure Hose	1	●	●	●	●	●	●
Q: Hose Reel	1	●	●	●	●	●	●
R: Soap Bottle Holder	1	●	●	●	●	●	●
S: Soap Bottle	1	●	●	●	●	●	●
T: Detachable Foot	1	●	●	●	●	●	●

** One filter comes in the machine water inlet, an extra is provided in the hardware bag.

WARNINGS

This owner's manual is considered a permanent part of the pressure washer and should remain with the pressure washer if resold. The information and specifications included in this publication were in effect at the time of approval for printing.

GXi Outdoor Power, LLC reserves the right to discontinue or change specifications or design at any time without notice and without incurring any obligation whatever. No part of this publication may be reproduced without written permission.

SAFETY LABEL LOCATIONS

These labels warn you of potential hazards that can cause serious injury. Read them carefully. If a label comes off or becomes hard to read, contact Customer Care for a replacement.

SAFETY INFORMATION

BEAST pressure washers are designed to give safe and dependable service if operated according to instructions. Read and understand this owner's manual before operating your pressure washer.

OPERATOR RESPONSIBILITY

Know how to stop the pressure washer quickly in case of emergency. Understand the use of all product controls, output receptacles, and connections. Be sure that anyone who operates the pressure washer receives proper instruction. Do not let children operate the pressure washer.



WARNING

Use of pressure washer can create puddles and slippery surfaces.

- The cleaning area should have adequate slopes and drainage to reduce the possibility of a fall due to slippery surfaces.

High pressure spray could cause you to fall if you are too close to the cleaning surface.

- Keep spray nozzle between 8 to 24 inches away from cleaning surface.
- Operate this unit on a stable surface.
- Be extremely careful if you must use the pressure washer from a ladder, scaffolding or any other relatively unstable location. Firmly grasp spray gun with both hands when using high pressure spray to avoid injury if gun kicks back.

Some chemicals or detergents may be harmful if inhaled or ingested, causing severe nausea, fainting or poisoning.

- Use a respirator or mask whenever there is a chance that vapors may be inhaled.
- Read all instructions with mask so you are certain the mask will provide the necessary protection against inhaling harmful vapors.

WHEN OPERATING EQUIPMENT

- Avoid accidental starts. Shut power "OFF" before connecting or disconnecting cord to electrical outlets.
- DO NOT spray flammable liquids.

- Do not use acids and solvents in this product. These products can cause physical injuries to the operator and irreversible damage to the machine.
- Do not use with toxic chemicals.
- To minimize the amount of water getting into the pressure washer, the unit should be placed as far as possible from the cleaning site during operation.
- Never carry your pressure washer by the cord. Do not pull on the cord to disconnect from the outlet.
- To allow free air circulation, the pressure washer should not be covered during operation.
- California Proposition 65: This product or its power cord contains lead, a chemical known to the State of California to cause cancer, birth defects or other reproductive harm. Wash hands after use.



WARNING

SAVE THESE INSTRUCTIONS

Servicing of a double-insulation product:

In a double-insulated product two systems of insulation are provided instead of grounding. No grounding means is provided on a double insulated product, nor should a means for grounding be added to the product. Servicing a double-insulated product requires extreme care and knowledge of the system, and should be done only by qualified service personnel. Replacement parts of a double-insulated product must be identical to the parts they replace. A double-insulated product is marked with the words "DOUBLE INSULATION" or "DOUBLE INSULATED".

The symbol may also be marked on the product.



WARNING

SAFETY FEATURES AND ELECTRICAL POWER INFORMATION

The pressure washer is equipped with a stop device that will sense when the trigger on the gun is released. It will open the power circuit to the motor and cause the pressure washer motor to stop. Motor will resume again when trigger is pulled.

The pressure washer is also equipped with a main power "ON/OFF" switch located on the unit. It should always be moved to the "OFF" position when the pressure washer is not being used to prevent possible injury or damage.

Ground Fault Circuit Interrupter:

This pressure washer has a ground-fault circuit-interrupter (GFCI) built into the plug of the power supply cord. This device provides additional protection from the risk of shock. Should replacement of the plug or cord become necessary, use only identical replacement parts that include GFCI protection.

Extension cords are not recommended unless they are plugged into a ground fault circuit-interrupter found in circuit boxes or protected receptacles.

WARNINGS

Extension Cords

If possible, do not use extension cords with this product. However, if you must use one, observe all the warnings and instructions listed below: Use a sufficient gauge:

- Maximum cable length: 50 ft = 14 AWG
- Use only extension cords that are intended for outdoor use. These extension cords are identified by a marking "Acceptable for use with outdoor appliances; store indoors while not in use."
- Use only extension cords having an electrical rating not less than the rating of the product.
- Do not use damaged extension cords. Examine extension cord before using and replace if damaged.
- Do not abuse extension cord and do not yank on any cord to disconnect.
- Keep cord away from heat and sharp edges.
- Always disconnect the extension cord from the receptacle before disconnecting the product from the extension cord.
- To reduce the risk of electrocution, keep all connections dry and off the ground. Do not touch plug with wet hands.

WARNING

The pressure washer is also equipped with a main power "ON/OFF" switch located on the unit. It should always be moved to the "OFF" position when the pressure washer is not being used to prevent possible injury or damage.



CAUTION

A pressure washer produces a high pressure spray which increases risk of injury and damage to unit.

- Gun Kicks Back - Hold with both hands!
- The trigger gun safety lock prevents the trigger from accidentally being engaged. The safety feature DOES NOT lock trigger in the ON position.
- DO NOT secure spray gun in open position.
- DO NOT leave spray gun unattended while machine is running.
- NEVER use a spray gun which does not have a trigger lock or trigger guard in place and in working order.
- Always be certain spray gun, nozzles and accessories are correctly attached.



CAUTION

High pressure spray may damage fragile items including glass.

- DO NOT point spray gun at glass when in jet spray mode.
- NEVER aim spray gun at people, animals, plants, electrical devices, or the unit itself.



WARNING

High pressure spray can cause paint chips or other particles to become airborne.

- Always wear eye protection when using this equipment or in vicinity of where equipment is in use.



CAUTION

Improper treatment of the pressure washer can damage it and shorten its life.

- If you have questions about intended use, ask dealer or contact Customer Service at [1] 919-550-3221.
- NEVER operate units with broken or missing parts, or without protective housing or covers.
- DO NOT bypass any safety device on this machine.
- Before starting pressure washer in cold weather, check all parts of the equipment to be sure ice has not formed there.
- NEVER move machine by pulling on high pressure hose. Use handle provided on unit.
- This equipment is designed to be used with BEAST authorized parts **ONLY**. If equipment is used with parts that DO NOT comply with minimum specifications, user assumes all risks and liabilities.



WARNING

The high pressure stream of water that this equipment produces can pierce skin and its underlying tissues, leading to serious injury and possible amputation.

Spray gun traps high water pressure, even when pump is not running and water is disconnected, which can cause injury.

- NEVER aim spray gun at people, animals, plants, electrical devices, or the unit itself.
- DO NOT allow children to operate pressure washer.
- To reduce the risk of injury, do not operate the machine near children
- NEVER repair high pressure hose. Replace it.
- NEVER repair leaking connections with sealant of any kind. Replace o-ring or seal.
- Keep high pressure hose connected to pump and spray gun while system is pressurized.
- ALWAYS point gun in safe direction and squeeze spray gun trigger, to release high pressure, every time you stop engine. Engage trigger lock when not in use.

Risk of Electrocution

- Inspect cord before using - Do not use if cord is damaged.
- Keep all connections dry and off the ground.
- Do not touch plug with wet hands.
- If possible, do not use extension cords with the product.
- Water spray must never be directed towards any electric wiring, electrical devices, or toward the unit itself.

Risk of Explosion

- DO NOT spray flammable liquids
- DO NOT use acids and solvents in this product. These products can cause physical injuries to the operator and irreversible damage to the machine.

PREPARATION & ASSEMBLY - Model P1450B, P1450B-CAN, P1500B, P1600B, P1600B-BB, P1600B-CAN

Assembly Time: 5 minutes

Tools Required: 17mm or Adjustable Wrench

Note: 17mm wrench (Part L pg. 3) is provided in hardware bag.

Surface Preparation

- Before starting any cleaning task, it is important to inspect the area for objects which could create a hazard.
- Remove any objects from the work area which could be tripped over, such as toys or outdoor furniture.

Step 1

- Remove or peel off blue protective film on the front of the pressure washer and on the wands (if applicable). Also, remove any bubble wrap. Discard blue protective film and bubble wrap.

Step 2

- Attach the Zinc Connect or Quick Connect Inlet coupling to water supply inlet on pressure washer, as shown in Figure below.
- On some models the coupling or quick connect may be installed at the factory for your convenience.

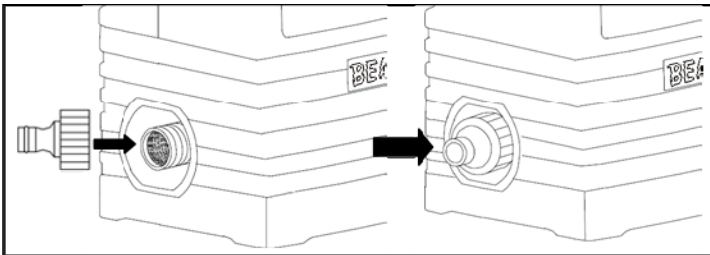

Step 3

- Attach Wand Bracket to the unit as shown in Figure below.

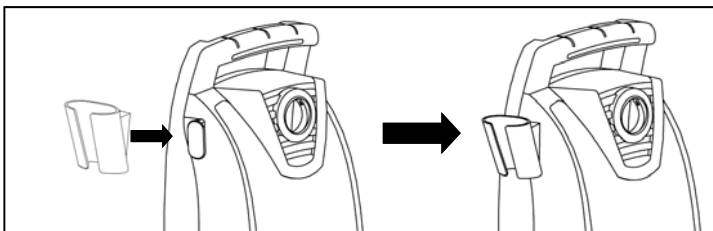

Step 4

- Attach High Pressure Hose to Main Unit as shown in Figure below.

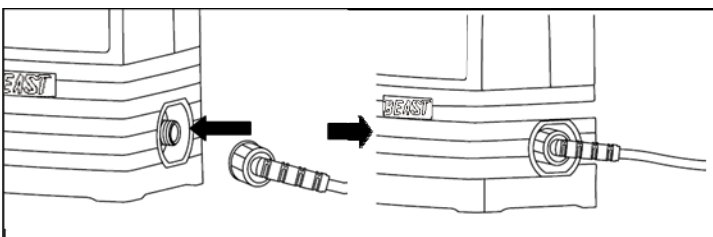

Step 5

- Attach other end of High Pressure Hose to Gun as shown in Figure below. Fasten tightly with 17mm wrench to avoid leakage.

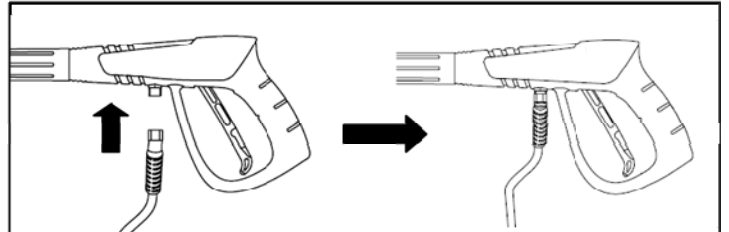

Step 6

- Attach Tool Belt to the Strap Bracket as shown in Figure below.
- The belt bracket is secured by two provided screws to the machine body.
- The bracket is installed at the factory on most models.

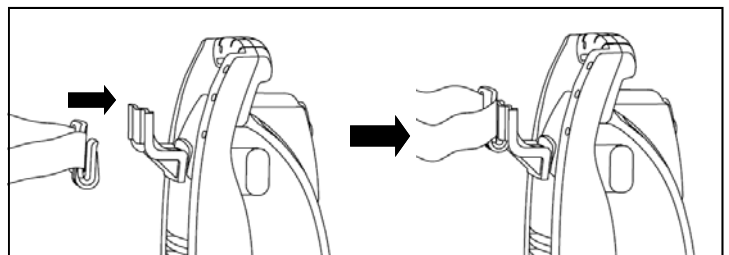

Step 7

- Attach the hose holder strap to the side of the unit as shown in Figure below.

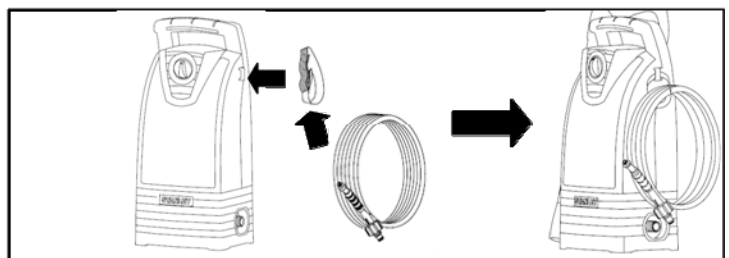

For Operating Instructions, proceed to page 9.

PREPARATION & ASSEMBLY - Model P1750B, P1750B-CAN, P1800B, P1800B-BB, P1800B-CAN, P2000B-BB

Assembly Time: 5 minutes

Tools Required: 17mm or Adjustable Wrench

Note: 17mm wrench (Part L pg. 3) is provided in hardware bag.

Surface Preparation

- Before starting any cleaning task, it is important to inspect the area for objects which could create a hazard.
- Remove any objects from the work area which could be tripped over, such as toys or outdoor furniture.

Step 1

- Remove or peel off blue protective film on the front of the pressure washer and on the wands (if applicable). Also, remove any bubble wrap. Discard blue protective film and bubble wrap.

Step 2

- Attach the Zinc Connect or Quick Connect Inlet coupling to water supply inlet on pressure washer as shown in Figure below.
- On some models the coupling or quick connect may be installed at the factory for your convenience.

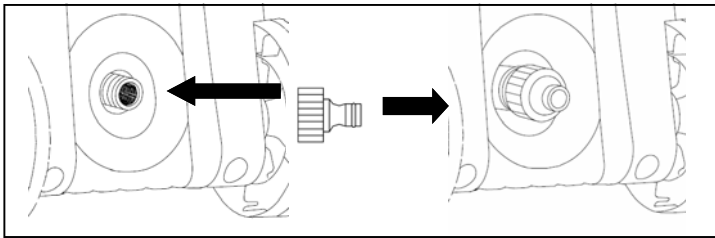

Step 3

- Attach the L-shape coupler end of the extension hose (F) into the water outlet as shown in Figure below. Fasten tightly to avoid leakage.

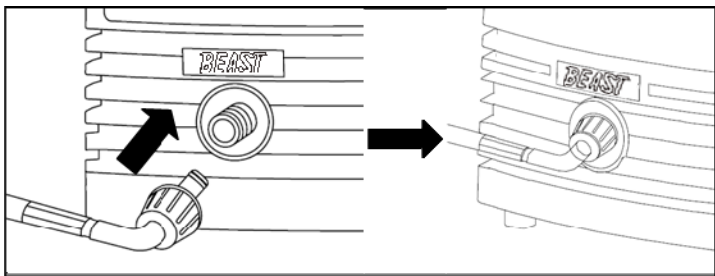

Step 4

- Attach the straight coupler end of the extension hose into the hose reel inlet as shown in Figure below. Fasten tightly to avoid leakage.

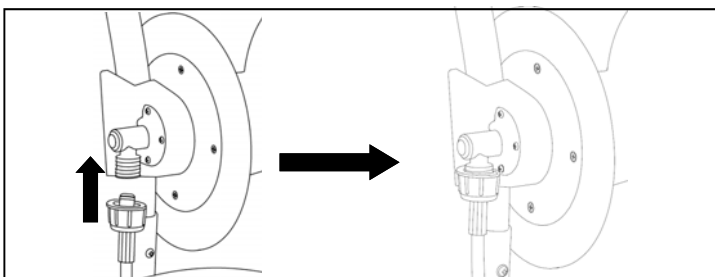

Step 5

- Attach the gun/wand holder as shown in the figure below.

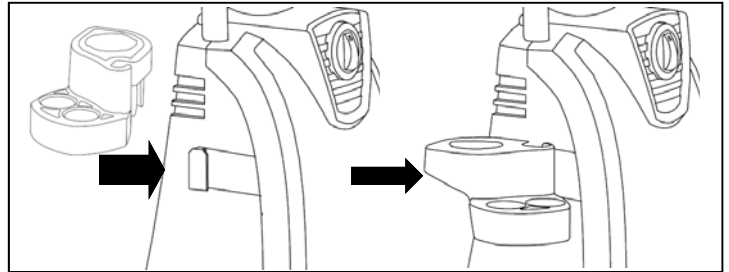

Step 6

- Attach the soap/detergent bracket. Bottle, siphon hose, as shown in the Figure below.

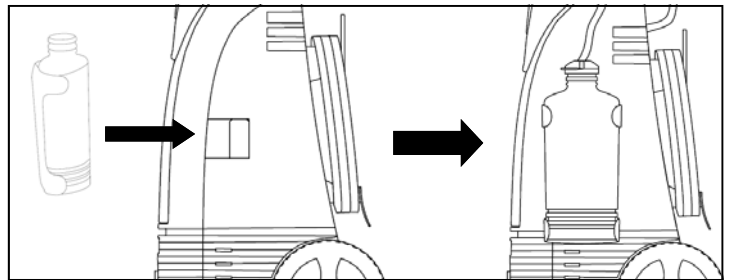

Step 7

- Attach High Pressure Hose to Gun as shown in Figure below. Fasten tightly with 17mm wrench to avoid leakage.

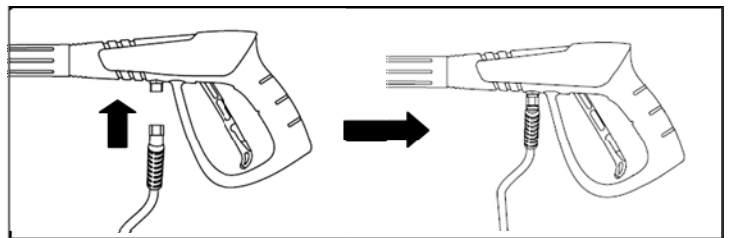

Step 8

- Attach foot bracket as shown in Figure below.

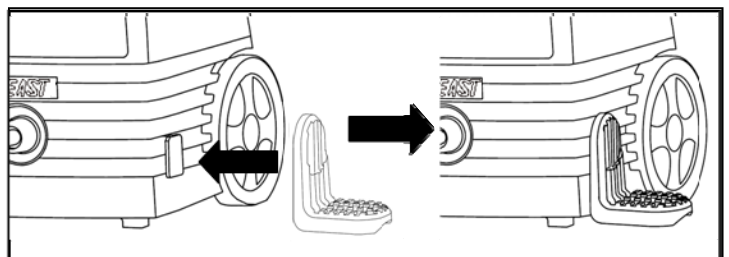

For Operating Instructions, proceed to page 9.

OPERATION

HOW TO USE THE PRESSURE WASHER

If you have any problems operating your pressure washer, please call the pressure washer help-line at [1] 919-550-3221.



WARNING

Pressure Washer Clearance

Prevailing winds and air currents should be taken into consideration when positioning pressure washer.

- Keep spray nozzle between 8 to 24 inches away from cleaning surface.
- Operate this unit on a stable surface.
- Be extremely careful if you must use the pressure washer from a ladder, scaffolding or any other relatively unstable location.
- Firmly grasp spray gun with both hands when using high pressure spray to avoid injury if gun kicks back.

High pressure spray could cause you to fall if you are too close to the cleaning surface.

CAUTION:

- **Never use the pressure washer to draw in water contaminated with solvents (e.g. paint thinners, gasoline, oil, etc.).**
- **Dirt in the feed water will damage the unit.**
- **To avoid this risk, we recommend checking the water filter (located inside the water inlet; to clean it out see Maintenance section on page 13). Always prevent debris from being drawn into the unit by using a clean water source and an accessory water filter if required.**

Water Supply (Cold Water Only):

- Do not draw non-water liquids through the unit. For use with cold water supply only.
- Water hose must be at least a 1/2 inch diameter.
- Flow rate of water supply must not fall below 2GPM (gallons per minute).
- Flow rate can be determined by running the water for one minute into an empty 5-gallon container.
- The water supply temperature must not exceed 104°F (40°C).

CAUTION:

- To prolong the life of the unit, it is recommended to rest the unit 5 minutes after every 30 minutes of use.

A pressure washer produces a high pressure spray which increases risk of injury and damage to unit.

- Always wear eye protection when using this equipment or in vicinity of where equipment is in use.
- Before starting the pressure washer, be sure you are wearing adequate eye protection.



WARNING

The high pressure stream of water that this equipment produces can pierce skin and its underlying tissues, leading to serious injury and possible amputation.

Spray gun traps high water pressure, even when motor is stopped and water is disconnected, which can cause injury.

- Keep high pressure hose connected to pump and spray gun while system is pressurized.
- ALWAYS point gun in safe direction and squeeze spray gun trigger, to release high pressure, every time you stop engine. Engage trigger lock when not in use.

Step 1:

- Make sure that the ON/OFF switch is in the "OFF" position.

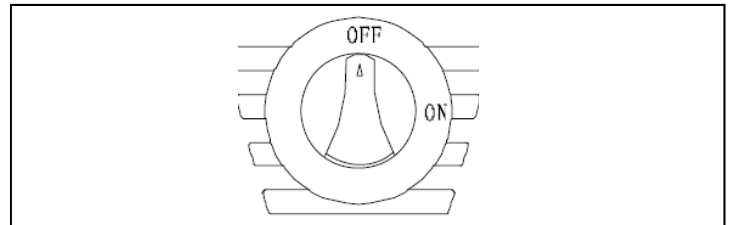

Step 2:

- Fasten the other end of the Zinc Connect to the or quick-connect coupling onto the garden hose and then attach the quick-connecting coupling to the inlet adaptor, as shown in the Figure

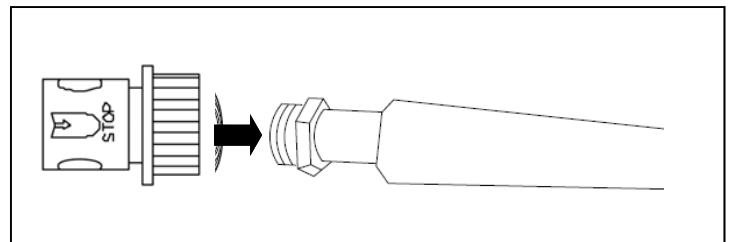

Step 3:

- Insert the desired wand into spray gun, and twist 1/4 turn until rectangular tab appears.

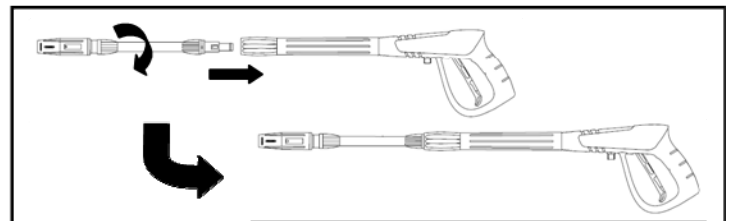

Step 4:

- To use another wand, reverse Step 3 and insert desired wand by repeating Step 3.

OPERATION



CAUTION

A pressure washer produces a high pressure spray which increases risk of injury and damage to unit.

- Gun Kicks Back - Hold with both hands!
- The trigger gun safety lock prevents the trigger from accidentally being engaged. The safety feature DOES NOT lock trigger in the ON position.
- DO NOT secure spray gun in open position.
- DO NOT leave spray gun unattended while machine is running.
- NEVER use a spray gun which does not have a trigger lock or trigger guard in place and in working order.
- Always be certain spray gun, nozzles and accessories are correctly attached.

Step 5:

- Attach garden hose to water supply and turn water on.

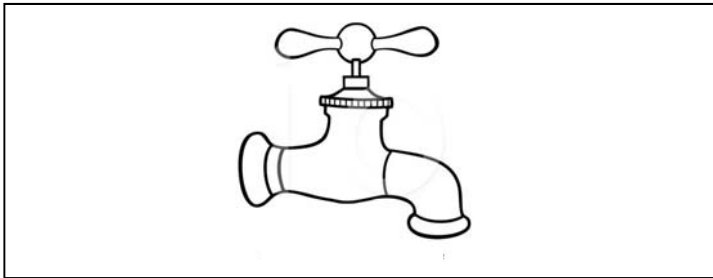

Step 6:

- Plug the unit into an outlet. **Make sure that the pressure washer is the only device plugged into the outlet.** *If plugging into a garage outlet, make sure there are no other devices plugged into any other outlets in the garage.* Press "TEST". Then press "RESET" to assure proper connection to power.

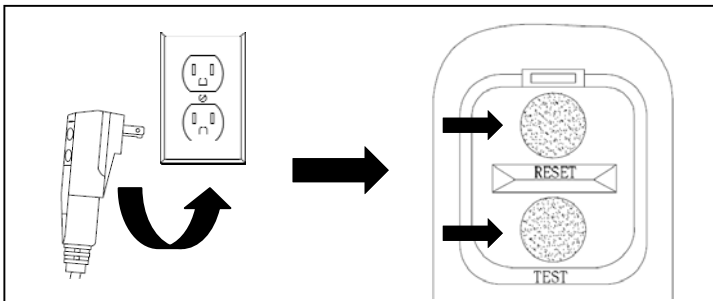

Step 7

- **IMPORTANT:** Before turning the unit "ON", depress the trigger to bleed any trapped air out of the pump and hose.

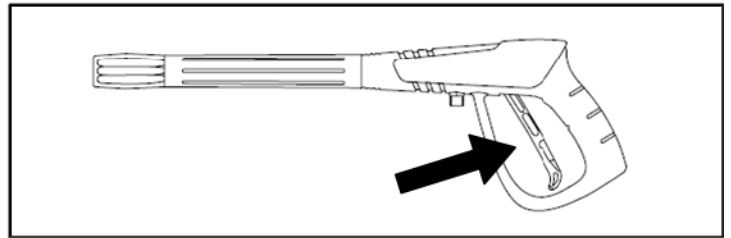

Step 8

- Release trigger and start the pressure washer by turning ON/OFF switch to ON.
- **IMPORTANT:** DO NOT turn the unit on without completing Step 7.

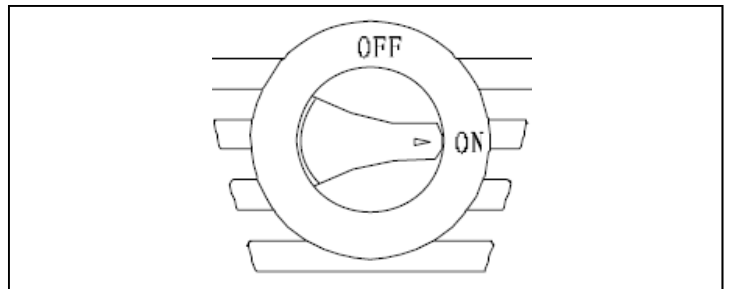

Step 9

Adjusting the spray

- Turning the nozzle allows the use of several different spray tips. Each spray tip provides a different spray pattern as shown in Figure below.

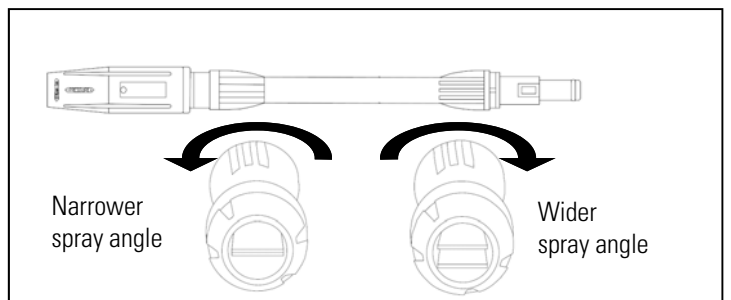

CAUTION:

- Jet spray adjustment is very aggressive. Do not adjust while spraying. We recommend that for most cleaning applications, a 20 degree spray angle should be used to avoid damage to the surface being sprayed.

To prolong the life of the unit, it is recommended to rest the unit 5 minutes after every 30 minutes of use.

OPERATION

WORKING WITH DETERGENTS

Working with detergent ensures a quick soaking of the dirt, and allows the high-pressure water to penetrate and remove the dirt more effectively. Always spray detergent on a dry surface. Do not pre-soak area with plain water. Wetting the surface first dilutes the detergent and reduces its cleaning ability.

To siphon and apply detergent, you must operate the pressure washer on low pressure. This provides a gentle application of detergent, with the pressure equivalent to a low-set garden hose. The high-pressure setting is used for cleaning; you cannot apply detergents when working at high-pressure. Always test detergent in an inconspicuous area before use.

Use only detergents designed for use with pressure washers; all detergents should be thin liquids, about the consistency of milk. Using thicker liquids such as car wash concentrate or dish soap will not allow the detergent to siphon.

Step 1

P1450B, P1500B, P1600B: Attach yellow detergent bottle to the spray gun as shown in Figure below.

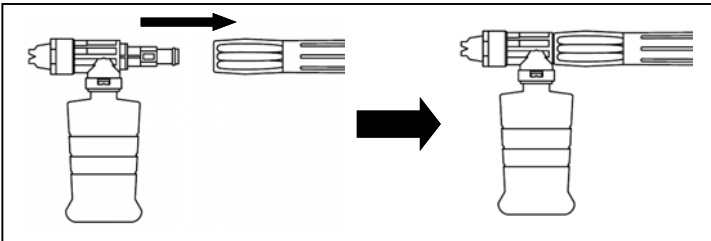

P1750B, P1800B, P2000B: Attach adjustable wand to spray gun.

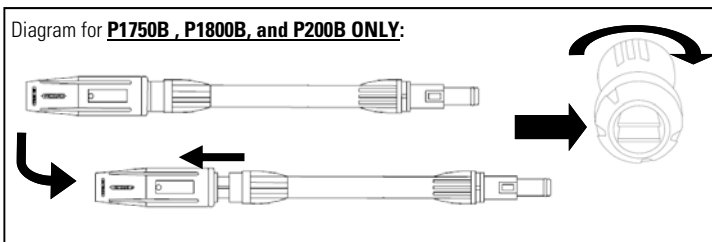

Step 2

P1750B and P1800B ONLY: Set the adjustable nozzle to the low-pressure setting. The nozzle must be set in the low-pressure position to apply detergent. Apply low pressure spray to a small area and then check surface for damage. If no damage is found, you can assume it is okay to continue cleaning. Start at top of area to be rinsed, working down with same overlapping strokes as used for cleaning.

Step 3

- Gently remove detergent container and fill with detergent.
- Re-attach containers back into position.
- Set pressure washer to low pressure by pulling the spray end of the wand out/downward.

Step 4

Turn the pressure washer to "ON". Pull trigger to operate the unit. The liquid detergent will automatically mix with water and be discharged through nozzle. Apply detergent to a DRY work surface, from bottom to top.

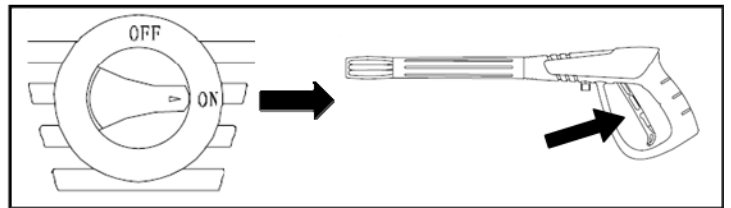

Step 5

Allow detergent to remain on the surface for a short time before rinsing. Do not allow detergent to dry on surface.

Step 6

Rinse with clean water under high-pressure. On a vertical surface, rinse from the bottom up, then rinse from the top down to avoid streaking. Hold nozzle 6-8 inch from the work surface at a 45 degree angle.

Step 7 (End of detergent application)

When you have finished using the detergent injection system, remove detergent suction tube from bottle and insert into 1 gallon (5L) of fresh water. Siphon water at low-pressure for one to two minutes so that all detergent is flushed through system. Remove detergent bottle and rinse



CAUTION

Damage may occur to painted surface if chemical is allowed to dry on surface. Wash and rinse a small section at a time. Avoid working on hot surfaces or in direct sunlight

Failure to clean properly will cause the injection system to become clogged and inoperable.

Never use:

- **Bleach, chlorine products and other corrosive chemicals**
- **Liquids containing solvents (i.e., paint thinners, gasoline, oils)**
- **Tri-sodium phosphate products**
- **Ammonia products**
- **Acid-based products**

These chemicals will harm the unit and will damage the surface being cleaned..

OPERATION

Shutting Down and Cleaning Up

Step 1

Turn the switch to "OFF" (0) position and unplug cord from outlet.

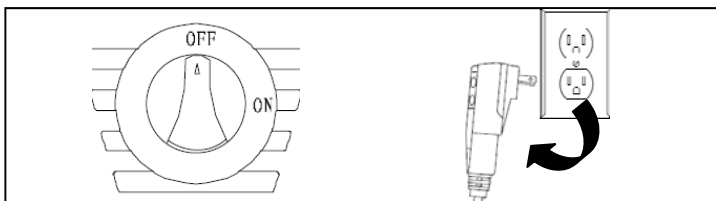

Step 2

Turn off the water supply.

Step 3

Press trigger to release water pressure for 20~30 seconds.

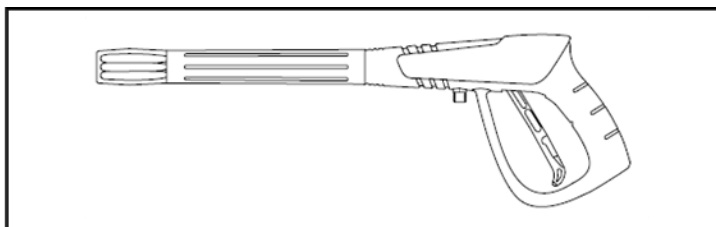

WARNING

Turn off water supply and squeeze trigger to depressurize the unit. Failure to do so could result in personal injury due to discharge of high-pressure water.

Step 4

Disconnect the garden hose from the water inlet on the unit.

Step 5

Disconnect the high-pressure hose from the high pressure outlet and engage the gun safety lock.

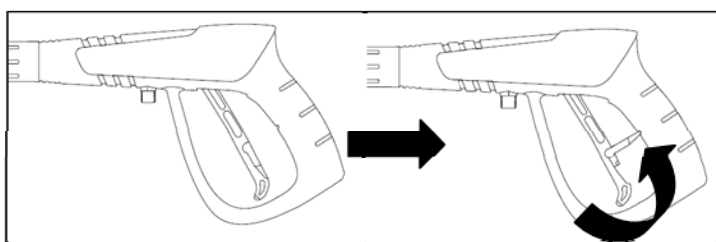

STEPPING AWAY OR TAKING A BREAK

If taking a break of five minutes or more:

1. Engage gun safety lock.
2. Turn pressure washer to "OFF" (0) position.
3. Unplug the power cord from the outlet.

Winterizing and Long Term Storage

STORING

Before storing the unit for an extended period, be sure the storage area is free of excessive humidity and dust.

Storage Preparation for Pressure Washer

Water should not remain in the unit for long periods of time. Sediments or minerals can deposit on pump parts and "freeze" pump action. If you do not plan to use the pressure washer for more than 30 days, follow this procedure:

1. Flush detergent injection hose by placing filter into a pail of clean water while running pressure washer in low pressure mode. Flush for one to two minutes.
2. Turn the on/off switch to "OFF" and unplug the unit.
3. Turn off the water supply and disconnect the hose from the unit.
4. Empty the unit of liquids by squeezing the trigger on the gun and holding until no more water comes from the pump. Failure to depressurize the unit could result in personal injury due to high pressure water discharge.
5. Ensure pump is clean and empty to prevent corrosion build up and freezing of pump components.
6. Store unit in a clean, dry area.

It is recommended to store the unit indoors to prevent exposure to freezing temperatures that may damage the pump.



CAUTION

You must protect your unit from freezing temperatures.

- Failure to do so may permanently damage your pump and render your unit inoperable.
- Freeze damage is not covered under warranty.

Alternative Procedure

If you cannot perform the Optimum Winterizing procedure, you can still protect your pressure washer from winter-damage:

1. Disconnect all water connections.
2. Turn on the machine for a few seconds. Press trigger to bleed any remaining water in the pump. Turn off immediately.
3. Remove the gun and hose from the pressure washer. Drain any excess water. Roll hose carefully and do not allow hose to be kinked.
4. Store the machine and accessories in a room that does not reach freezing temperatures. Do not store near furnace or other hot areas as it may dry out o-rings and pump seals.

CAUTION

Failure to follow the above directions will result in damage to the pump assembly and accessories and will void the warranty. We recommend the use of antifreeze (Pump Saver) to prevent cold weather damage during storage in the winter months.



CAUTION!

YOU MUST PROTECT YOUR UNIT FROM FREEZING TEMPERATURES

- Failure to do so may permanently damage your pump and render your unit inoperable.
- Freeze damage is not covered under warranty.

**TO PREVENT PREMATURE WEAR ON PRESSURE
WASHER PUMP, DO NOT ALLOW UNIT TO RUN MORE
THAN 30 MINUTES AT A TIME**

MAINTENANCE

Connections

Connections on pressure washer hoses, gun and spray wand should be cleaned regularly and lubricated with non-water soluble grease.

Adjustable Nozzle Maintenance

Surging, or pulsing sensation, felt while squeezing the spray gun trigger may be caused by excessive pump pressure. The principal cause of excessive pump pressure is a nozzle clogged or restricted with foreign materials, such as dirt, etc. To correct the problem, immediately clean the nozzle using the tools included with your pressure washer and follow these instructions:

1. Shut off pressure washer and turn off water supply.
2. Depressurize unit by squeezing trigger with wand away from face.
3. Remove wand from gun
4. Use needle included in kit to free any foreign material clogging or restricting spray tip, see Figure below.

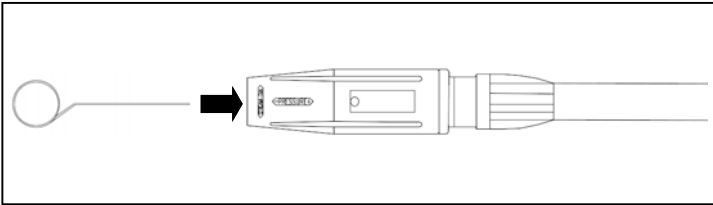

Adjustable Nozzle

For the adjustable nozzle, you can also lubricate the nozzle collar (high-pressure low-pressure) by using non-water soluble grease regularly.

Water Filter Screen

The pressure washer is equipped with a water inlet filter that prevents debris going into the pump. If the filter is not kept clean, the flow of water to the pressure washer will be restricted and the pump may be damaged.

1. To clean the screen, remove quick connector and remove the filter screen from the pump inlet.

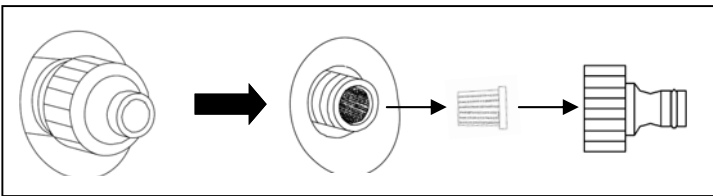

2. Rinse filter screen with warm water until it is free of debris and blockage. Check for any damage, replace if damaged.
3. Reinstall screen and quick-connector immediately.

Air Vents

The air vents located on the front and back of the pressure washer must be kept clean and free of any obstructions to ensure proper air-cooling of the motor during operation.

O-Ring Maintenance

Through the normal operation of your pressure washer, o-rings, which keep the connections of the hoses and spray gun tight and leak-free, may become worn or damaged. They should be lubricated with non-water soluble grease.



WARNING

The high pressure stream of water that this equipment produces can pierce skin and its underlying tissues, leading to serious injury and possible amputation.

- NEVER repair leaking connections with sealant of any kind. Replace o-ring or seal.

GENERAL MAINTENANCE RECOMMENDATIONS

The pressure washer warranty does not cover items that have been subjected to operator abuse or negligence. To receive full value from the warranty, the operator must maintain the pressure washer as instructed in this manual.

NOTE: Should you have questions about replacing components on your pressure washer, please call **[1] 919-550-3221** for assistance.

- All maintenance in this manual should be made at least once each season.

Before Each Use

1. Check water inlet screen for damage.
2. Check high pressure hose for leaks.
3. Check detergent siphoning tube and filter for damage.
4. Check spray gun, nozzle extension, and nozzles for leaks.
5. Rinse out garden hose to flush out debris.

Check High Pressure Hose

The high pressure hose can develop leaks from wear, kinking, or abuse. Inspect the hose each time before using it. Check for cuts, leaks, abrasions or bulging of cover, damage or movement of couplings. If any of these conditions exist, replace the hose immediately.



WARNING

The high pressure stream of water that this equipment produces can pierce skin and its underlying tissues, leading to serious injury and possible amputation.

- NEVER repair high pressure hose. Replace it.
- Replacement hose rating MUST exceed maximum pressure rating of unit.

Check Detergent Siphoning Tube

Examine the filter on the detergent tube and clean if clogged. The tube should fit tightly on the barbed fitting. Examine the tube for leaks or tears. Replace the filter or tube if either is damaged.

Check Gun and Nozzle Extension

Examine the hose connection to the spray gun and make sure it is secure. Test the trigger by pressing it and making sure it springs back into place when you release it. Put the trigger lock in the on position and test the trigger. You should not be able to press the trigger.

Tips for Cleaning

CAUTION

- Before cleaning any surface an inconspicuous area should be cleaned to test spray pattern and distance for maximum cleaning results.
- If painted surfaces are peeling or chipping, use extreme caution as pressure washer may remove the loose paint from the surface.
- When using on surfaces which might come in contact with food, flush surfaces with plenty of drinking water.

Automobiles, RV's, Boats, Motorcycles, ATV's

Pre-rinse vehicle with fresh water. If using detergent, apply to surface at low pressure. For best results, clean one side of vehicle at a time and always apply detergent from bottom to top, do not allow detergent to dry on surface. If needed, use special wash brush attachment (not included) to remove stubborn dirt. Rinse at high pressure in a sweeping motion keeping the spray nozzle approximately 6-8 inches from the cleaning surface (distance should increase when rinsing pin-striping or other sensitive surfaces). Always clean from top to bottom and from left to right. For best results, wipe surface dry with a chamois or soft dry cloth.

BBQ Grills, Gardening Tools, Mowers/Trimmers

Pre-rinse cleaning surface with fresh water. If using detergent or Degreaser, apply detergent at low pressure. Allow detergent to remain on surface 1-3 minutes. Do not allow detergent to dry on surface. Rinse at high pressure keeping the spray nozzle approximately 3-6 inches from the cleaning surface. For removing extremely stubborn dirt, it may be necessary to move the spray nozzle even closer to the surface for greater dirt cutting action.

Driveway, Sidewalks, Patios, Brick

Pre-rinse cleaning surface with fresh water. If using detergent or Degreaser, apply to surface at low pressure. For best results, limit your work area to smaller sections of approximately 25 square feet. Allow detergent or Degreaser to remain on surface 1-3 minutes. Do not allow detergent to dry on surface. Rinse at high pressure in a sweeping motion keeping the spray nozzle approximately 3-6 inches from the cleaning surface. Always clean from top to bottom and from left to right. For removing extremely stubborn stains, use the Turbo Nozzle.

Decks

Pre-rinse deck and surrounding area with fresh water. If using detergent, apply to surface at low pressure. For best results, limit your work area to smaller sections of approximately 25 square feet. Allow detergent to remain on surface 1-3 minutes. Do not allow detergent to dry on surface. Rinse at high pressure in a long sweeping motion keeping the spray nozzle approximately 3-6 inches from the cleaning surface. Always clean from top to bottom and from left to right. When moving on to a new section of the cleaning surface, be sure to overlap the previous section to eliminate stop marks and ensure a more even cleaning result.

House Siding

(Pre-rinse cleaning surface with fresh water. If using detergent, apply to surface at low pressure (for best results, limit your work area to sections of approximately 6 feet and always apply detergent from bottom to top). Allow detergent to remain on surface 1-3 minutes. Do not allow detergent to dry on surface, if surface appears to be drying, simply wet down surface with fresh water. If needed, use special wash brush attachment (not included) to remove stubborn dirt. Rinse at high pressure from top to bottom in an even sweeping motion keeping the spray nozzle approximately 6 inches from the cleaning surface.

Patio and Lawn Furniture

Pre-rinse furniture and surrounding area with fresh water. If using detergent, apply to surface at low pressure. Allow detergent to remain on surface 1-3 minutes. Do not allow detergent to dry on surface. If needed use special Wash Brush attachment (not included) to remove stubborn dirt. Rinse at high pressure in a sweeping motion keeping the spray nozzle approximately 3-6 inches from the cleaning surface. For best results, clean from top to bottom and from left to right.

TROUBLESHOOTING

Symptom	Cause	Solution
Motor will not start	On/Off switch is in the "OFF" (0) position.	Turn switch to the "ON" position
	Power cord is not plugged in.	Plug in power cord.
	Electrical outlet does not supply adequate power.	Try a different outlet.
	Tripped GFCI plug.	Press "RESET" button on GFCI plug.
	Tripped circuit breaker.	Switch off pressure washer. The reset comes automatically once the temperature of the unit drops.
	Plugged Wand	Turn unit off. If wand is plugged, then the water will be at full pressure making disconnecting wand difficult. Carefully disconnect wand and/or gun, clean wand.
Unit does not reach high pressure.	Diameter of garden hose is too small.	Replace with a 5/8 inch or larger garden hose.
	Water supply is restricted.	Check garden hose for kinks, leaks and blockage.
	Not enough inlet water supply.	Open water source full force.
	Water inlet filter is clogged.	Remove filter and rinse out in warm water.
	Spray wand is on low pressure position	Turn spray wand to high pressure position (See p.10)

Troubleshooting continued on next page...

TROUBLESHOOTING (continued)

Symptom	Cause	Solution
Output pressure varies high and low.	Not enough inlet water supply.	Turn water on full force. Check garden hose for kinks, leaks or blockage.
	Pump is sucking air.	Check that hoses and fittings are air tight. Turn off machine. Purge pump by squeezing trigger gun until a steady flow of water emerges through the nozzle.
	Water inlet filter is clogged.	Remove filter and rinse out in warm water.
	Discharge nozzle is obstructed.	Blow out or remove debris with a fine needle.
	Calcified gun, hose or spray wand.	Run distilled vinegar through detergent suction tube.
No detergent.	Detergent suction tube not properly connected to the machine.	Check connection.
	Detergent is too thick.	Dilute detergent, for best results use recommended detergent.
	Filter on detergent suction tube is clogged.	Run warm water through filter to remove debris.
	Damaged or clogged detergent suction tube.	Remove obstruction or replace detergent suction tube.
	Spray wand is in high pressure position.	Turn spray wand tip to low pressure position.
	Discharge nozzle is obstructed.	Blow out or remove
Garden hose connection leaks.	Loose fittings.	Tighten fittings.
	Missing/worn rubber washer.	Insert new washer.
Spray wand, or extension, or nozzle leaks.	Spray nozzle not properly attached.	Insert the spray nozzle into the trigger. Carefully press in against the spring tension and twist into the locked position.
	Broken o-ring or plastic insert.	Call Customer Support
Pump is noisy.	Pump is sucking air.	Check that hoses and fittings are air tight. Turn off machine and purge pump by squeezing trigger gun until a steady flow of water emerges through the nozzle.
Water leaks from pump (up to 10 drops per minute is permissible).	Loose fittings.	Check that all fittings are tight.
	Water seals are damaged or worn.	Call Customer Support
Oil Drips.	Oil seals are damaged or worn.	Call Customer Support
Motor buzzes but fails to run.	Supply voltage below minimum.	Verify that only the pressure washer is running on this circuit.
	System has residual pressure.	Turn unit "OFF", squeeze trigger on spray wand to release pressure, then turn unit "ON".
	Voltage loss due to extension cord.	Do not use extension cord with this unit—plug directly into power outlet.
	Pressure washer not used for long periods	Call Customer Service.

IF YOU ENCOUNTER ANY ADDITIONAL DIFFICULTIES NOT LISTED, CALL CUSTOMER SERVICE AT [1] 919-550-3221 FOR ASSISTANCE.

Spare Parts List for Beast Electric Pressure Washers

Part/Description	Part Number	Price
Spray Gun	SP00109	\$30.00
Adjustable Wand (P1450B, P1500B, and P1600B)	SP00209	\$30.00
Adjustable Wand (P1750B, P1800B, and P2000B)	SP00309	\$30.00
Turbo Wand	SP00409	\$30.00
Straight Brush	SP00809	\$30.00
Rotary Brush	SP00709	\$30.00
Soap Injector Bottle (P1450B, P1500B, and P1600B)	SP00909	\$30.00
Soap bottle and Bracket (P1750B, P1800B, and P2000B)	SP01809	\$30.00
Gun Holder (P1450B, P1500B, and P1600B)	SP01009	\$30.00
Gun and Wand Holder (P1750B, P1800B, and P2000B)	SP01409	\$30.00
High Pressure Hose (P1450B, P1500B, and P1600B)	SP00509	\$30.00
High Pressure Hose (P1750B, P1800B, and P2000B)	SP02412	\$30.00
Extension Hose (P1750B, P1800B, and P2000B)	SP01509	\$25.00
Zinc Connect	SP04212	\$10.00
Plastic Quick Connect	SP02509	\$8.00
Brass Quick Connect	SP01309	\$15.00
Hose Strap (P1450B, P1500B, and P1600B)	SP01209	\$20.00
Tool Belt (P1450B, P1500B, and P1600B)	SP01109	\$45.00
Hose Reel (P1750B, P1800B, and P2000B)	SP01609	\$45.00
Hose Reel Handle (P1750B, P1800B, and P2000B)	SP01709	\$40.00
Foot Rest (P1750B, P1800B, and P2000B)	SP01909	\$25.00
Hardware Bag Includes: <input type="checkbox"/> 17mm Wrench <input type="checkbox"/> Spare Water Filter <input type="checkbox"/> Spare O-Rings <input type="checkbox"/> Cleaning Needle <input type="checkbox"/> Product Manual	SP00609	\$20.00

To order spare parts, visit ServiceandWarrantyOnline.com to place an order, or fill out the "Spare Parts Order Form" included in your product's packaging. Be sure to include all billing and shipping information and fax the order to [1] 919-550-3277 or call [1] 919-550-3221 .

All sales are final. To check on an order status, please call [1] 919-550-3221 or email CustomerService@GXiooutdoorpower.com.

Limited Warranty & Service

LIMITED 1 YEAR WARRANTY

TERM OF THIS WARRANTY:

This pressure washer is warranted to be free of defects in materials and workmanship under normal residential use for a period of 1 year. This warranty applies to the electric motor and the pump for 1 year. (Normal wear and maintenance items such as the cord, GFCI breaker, wand, hose, tips, seals, and other attachments are warranted for 90 days.) Warranty repairs will be made without charge for parts and labor for the first 90 days from the date of purchase. After the first 90 days, this limited warranty covers the costs of replacement parts on the pressure washer unit only. Any commercial, industrial or rental use of the product will reduce the term of this warranty to 30 days for all components.

TO QUALIFY FOR THIS WARRANTY:

The product must be purchased in the United States, Canada or Mexico from a retail store authorized by GXi Outdoor Power Equipment LLC to sell the product. This warranty applies to first retail purchaser / owner during the applicable warranty time period. A proof of purchase receipt showing date of purchase and authorized retail store and a valid product serial number are required to demonstrate warranty eligibility.

WHAT GXI PARTS AND SERVICE LLC WILL REPAIR OR REPLACE UNDER WARRANTY:

GXI PARTS AND SERVICE LLC will repair or replace, at its option, any part that is proven to be defective in material or workmanship under normal use during the applicable warranty time period subject to the exclusions stated herein. This warranty is void if the owner fails to follow the prescribed maintenance and operating procedures described in this manual. Only failures where an identifiable manufacturing defect can be identified will be covered under the terms of this warranty.

GXI PARTS AND SERVICE LLC has the right to recover warranty administration costs from the owner if the root cause of the malfunction was found to be other than defective material or workmanship. Anything replaced under warranty becomes the property of GXI PARTS AND SERVICE LLC. Parts replaced under warranty will be considered as part of the original product and any warranty on those parts will expire coincident with the original product warranty.

TO OBTAIN WARRANTY SERVICE:

Contact GXI PARTS AND SERVICE LLC to obtain warranty return authorization and directions as to where to send your product for evaluation. **Have your proof of purchase and the product serial number available when you call.**

If you are not satisfied with warranty service, contact GXi PARTS AND SERVICE LLC. If you are unable to resolve problems and require further assistance, write to GXI PARTS AND SERVICE LLC Customer Service.

EXCLUSIONS:

THIS WARRANTY DOES NOT EXTEND TO PARTS AFFECTED OR DAMAGED BY ACCIDENT AND/OR COLLISION, NORMAL WEAR, CONTAMINATION, USE IN AN APPLICATION FOR WHICH THE PRODUCT WAS NOT DESIGNED OR ANY OTHER MISUSE, NEGLIGENCE, INCORPORATION OR USE OF UNSUITABLE ATTACHMENTS OR PARTS, UNAUTHORIZED ALTERATION, OR ANY CAUSES OTHER THAN DEFECTS IN MATERIAL OR WORKMANSHIP OF THE PRODUCT. IN PARTICULAR, THIS WARRANTY DOES NOT COVER DAMAGE CAUSED BY FAILURE TO FOLLOW PRESCRIBED WARNINGS AND OPERATING PRACTICES; FAILURE TO FOLLOW PROPER MAINTENANCE AND STORAGE PROCEDURES; AND PHYSICAL DAMAGE DUE TO SHIPPING, HANDLING OR STORAGE.

DISCLAIMER OF CONSEQUENTIAL DAMAGE AND LIMITATION OF IMPLIED WARRANTIES:

GXI PARTS AND SERVICE LLC DISCLAIMS ANY RESPONSIBILITY FOR LOSS OF TIME OR USE OF THE PRODUCT, TRANSPORTATION, COMMERCIAL LOSS, OR ANY OTHER INCIDENTAL OR CONSEQUENTIAL DAMAGE. ANY IMPLIED WARRANTIES ARE LIMITED TO THE DURATION OF THIS WRITTEN LIMITED WARRANTY.

THIS WARRANTY IS VOID IF THE MANUFACTURING DATE AND THE SERIAL NUMBER ON THE EQUIPMENT HAS BEEN REMOVED OR THE EQUIPMENT HAS BEEN MODIFIED.

The word "BEAST" is written in a bold, grey, 3D-style font. To the right of the word are four black, jagged claw marks that appear to be scratching the surface.

Commercial Lawn Mowers

Heavy Duty Pressure Washers

Chipper Shredders

Generator Accessories