



TABLE OF CONTENTS

Options

Grid Options	2
Grille Patterns	3
Trim Options	7

Section Details

No Nail Fin:	
Vertical Section	8
Horizontal Section	9
Pocket Filler Geometric:	
Vertical Section	10
Horizontal Section	11
Slope Sill:	
Vertical Section	12
Horizontal Section	13
Flush Fin Geometric:	
Vertical Section	14
Horizontal Section	15



GRID OPTIONS

← Exterior / Interior →

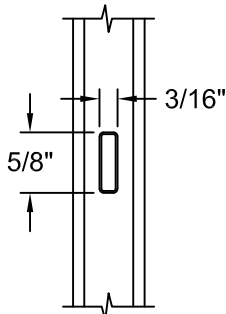

5/8" Flat GBG

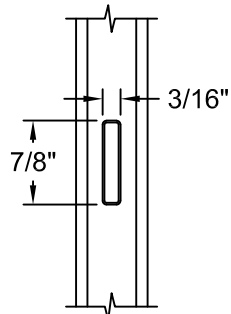

7/8" Flat GBG

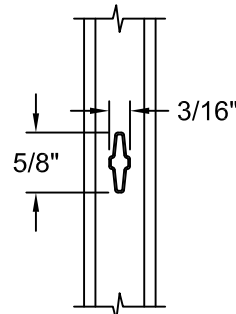

5/8" Contour GBG

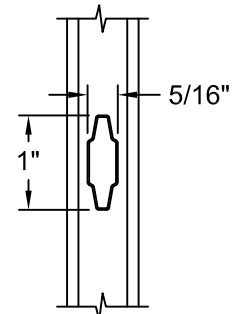

1" Contour GBG

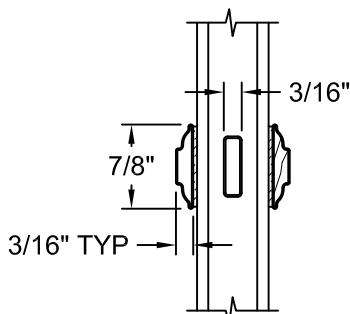

7/8" Contour SDL

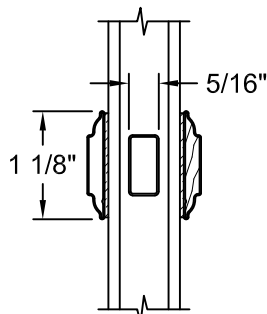

1 1/8" Contour SDL

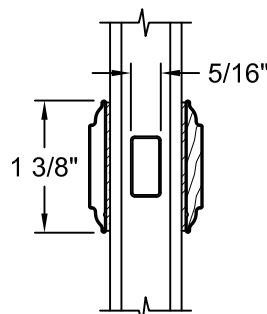

1 3/8" Contour SDL

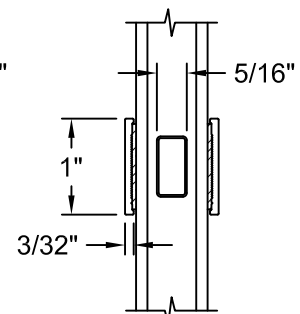

1" Flat SDL

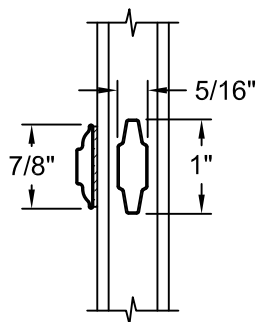

7/8" Contour SDL
1" Contour GBG

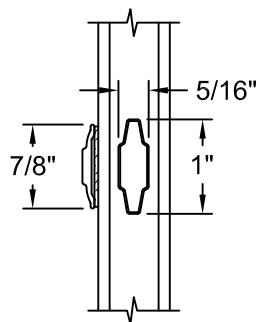

7/8" Contour Slim SDL
1" Contour GBG

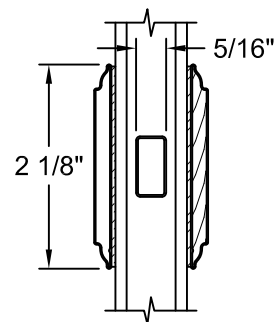

2 1/8" Variable SDL
Non-Intersecting Only

Note: SDL tape thickness is .04"

GRILLE PATTERNS

Rectangular

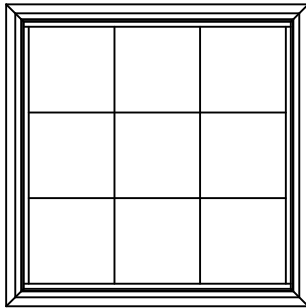

Standard

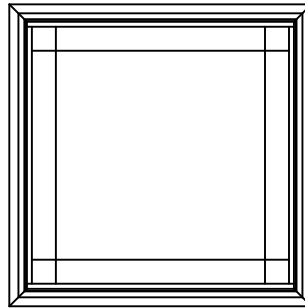

Prairie Glass

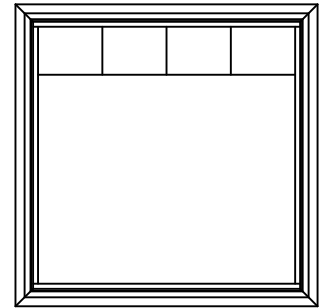

Colonial Top Down

Full Round

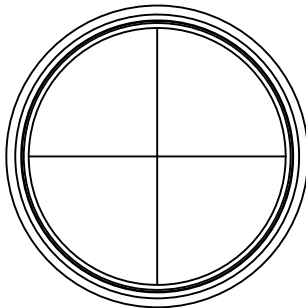

FR4

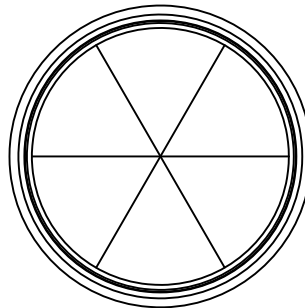

FR6

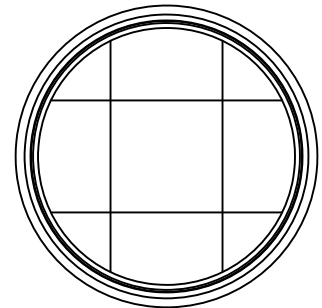

FR9

GRILLE PATTERNS - QUARTER ROUND

Quarter Round

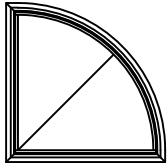

QR2

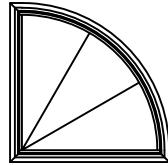

QR3

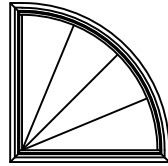

QR5

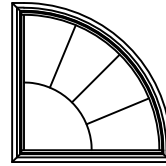

QR6

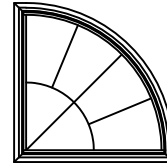

QR7

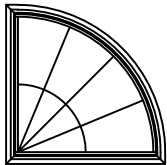

QR8

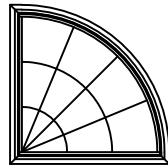

QR9

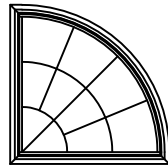

QR10

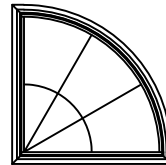

QR11

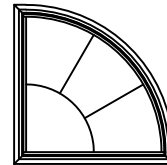

QR12

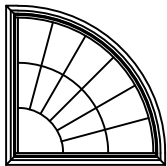

QR13

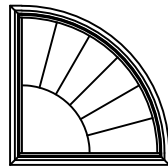

QR14

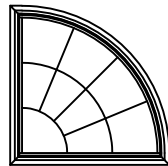

QR15

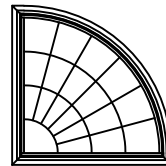

QR16

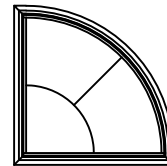

QR19

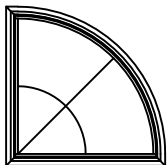

QR20

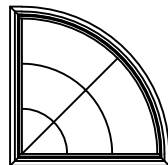

QR21

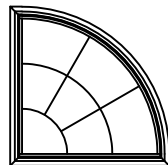

QR22



GRILLE PATTERNS

Half Round

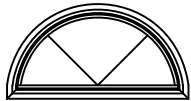

HR-3

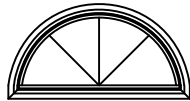

HR-5

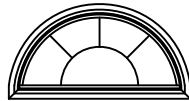

HR-6

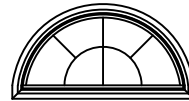

HR-7



HR-8



HR-9



HR-10



HR-11



HR-12



HR-13



HR-14



HR-15



HR-16



HR-17



HR-18



HR-19



HR-20



HR-23



HR-24



GRILLE PATTERNS

Extended Quarter Round

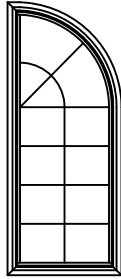

QT1

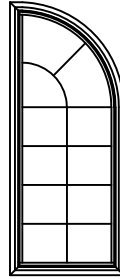

QT2

Extended Half Round

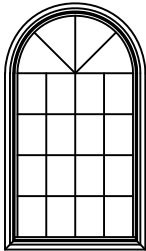

RT1

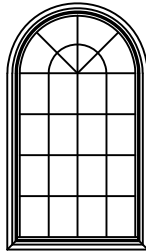

RT2

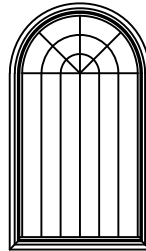

RT3

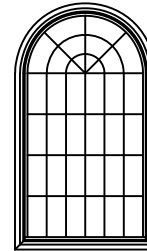

RT4

Extended Circle Segment

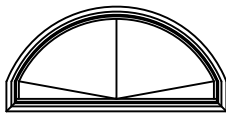

LP1

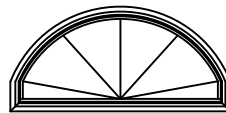

LP2

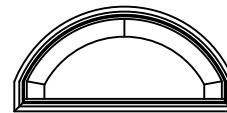

LP3

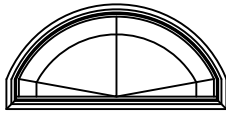

LP4



LP5

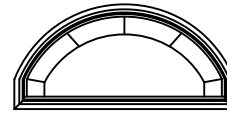

LP7

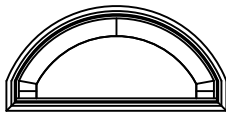

LP8

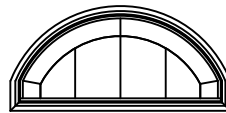

LP14

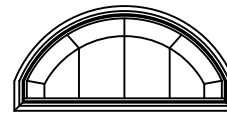

LP16



LP18



TRIM OPTIONS

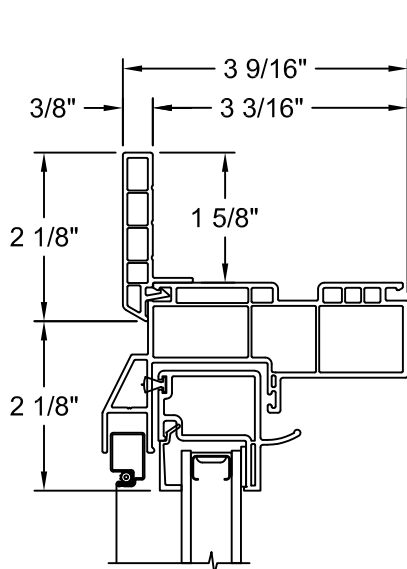

1 5/8" Flush Fin

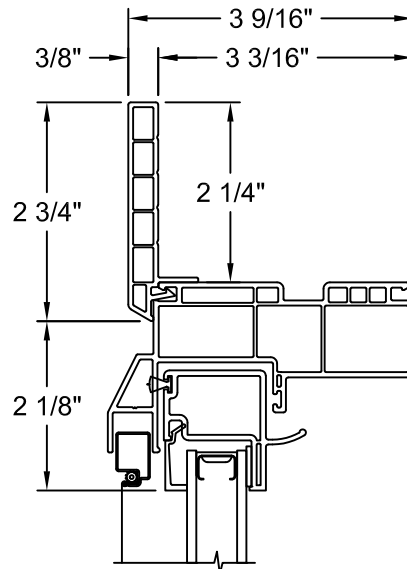

2 1/4" Flush Fin

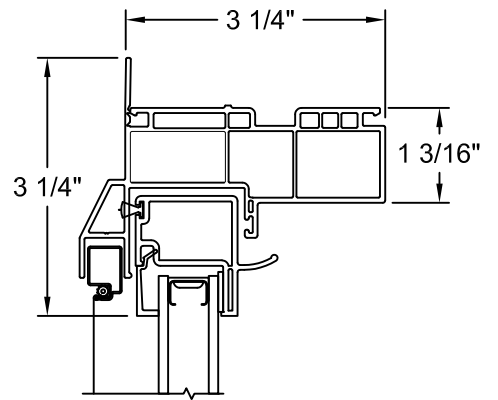

Florida Flange

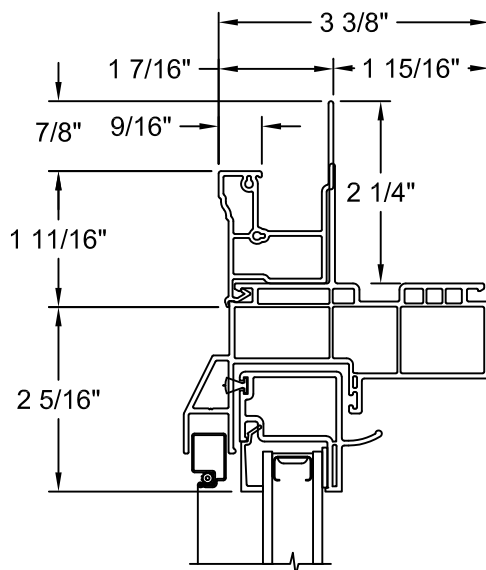

Brickmould

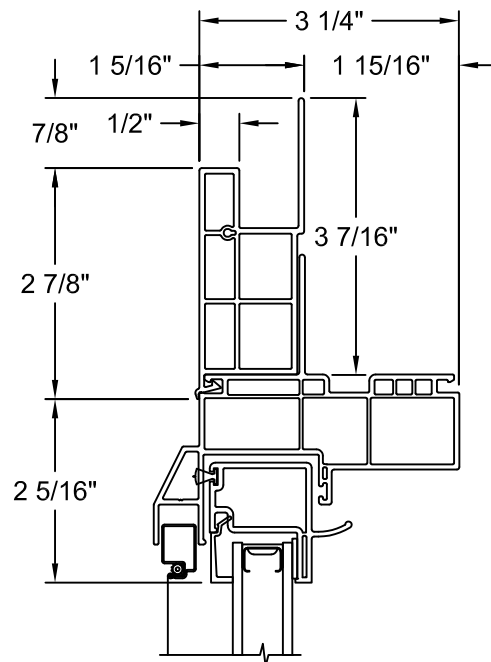

Flat Casing



NO NAIL FIN - VERTICAL SECTION

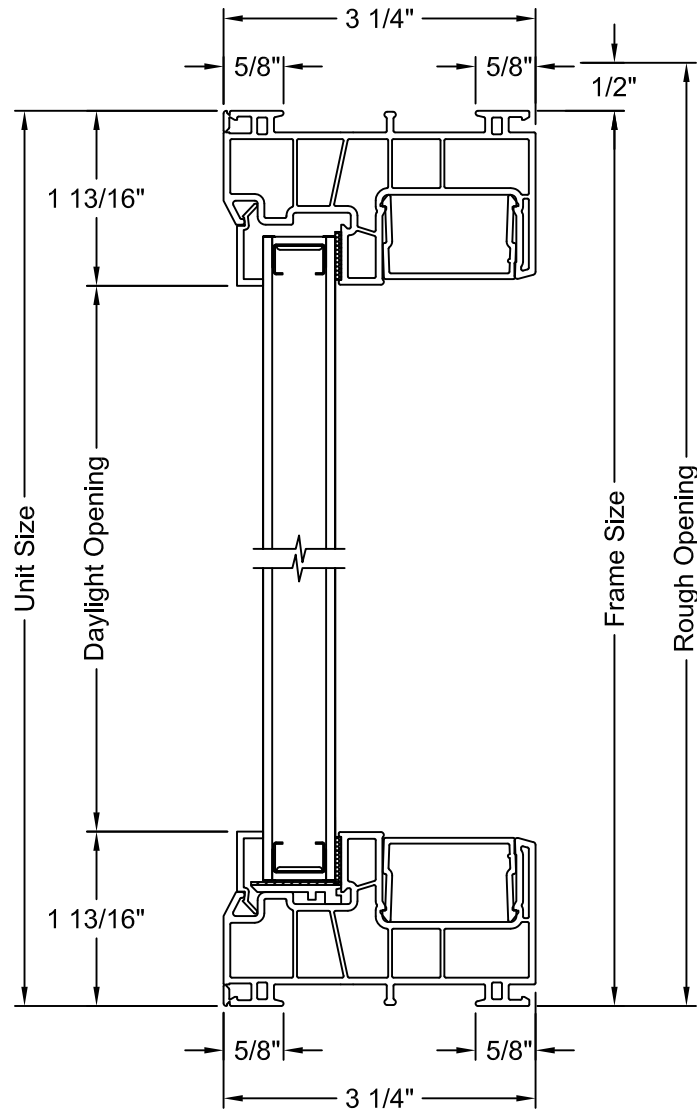



NO NAIL FIN - HORIZONTAL SECTION

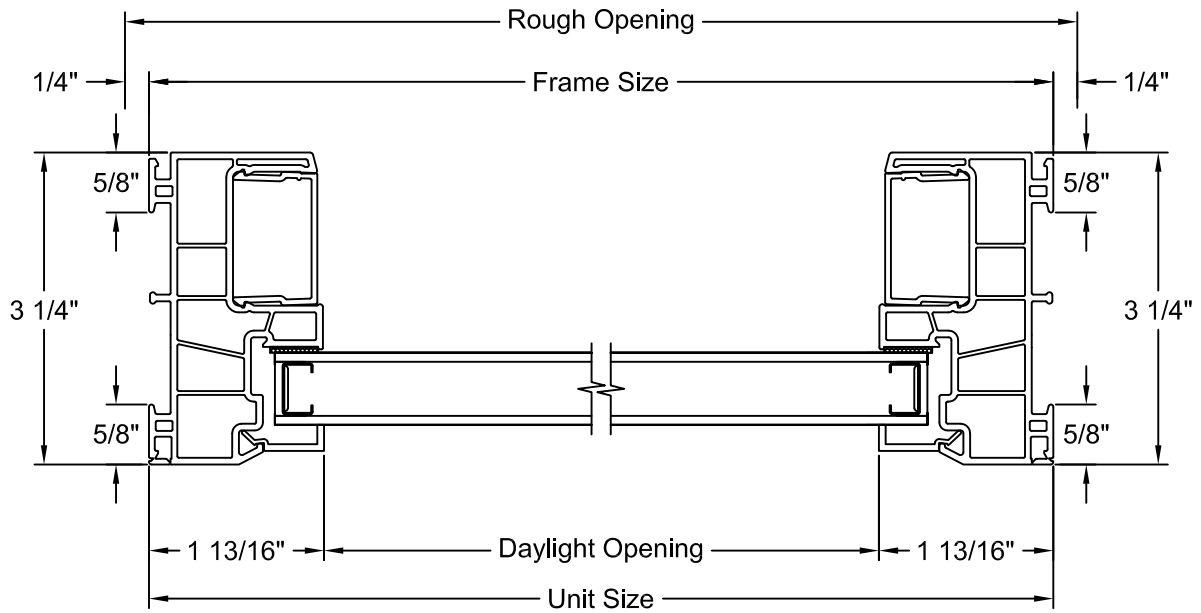



POCKET FILLER GEOMETRIC - VERTICAL SECTION

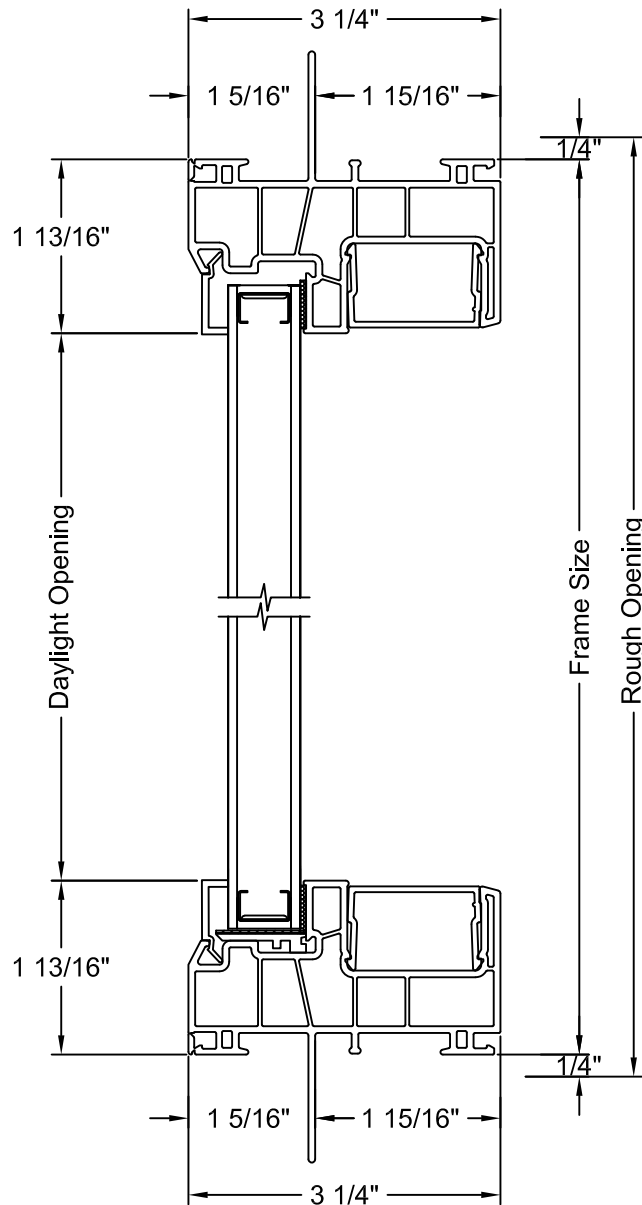



POCKET FILLER GEOMETRIC - HORIZONTAL SECTION

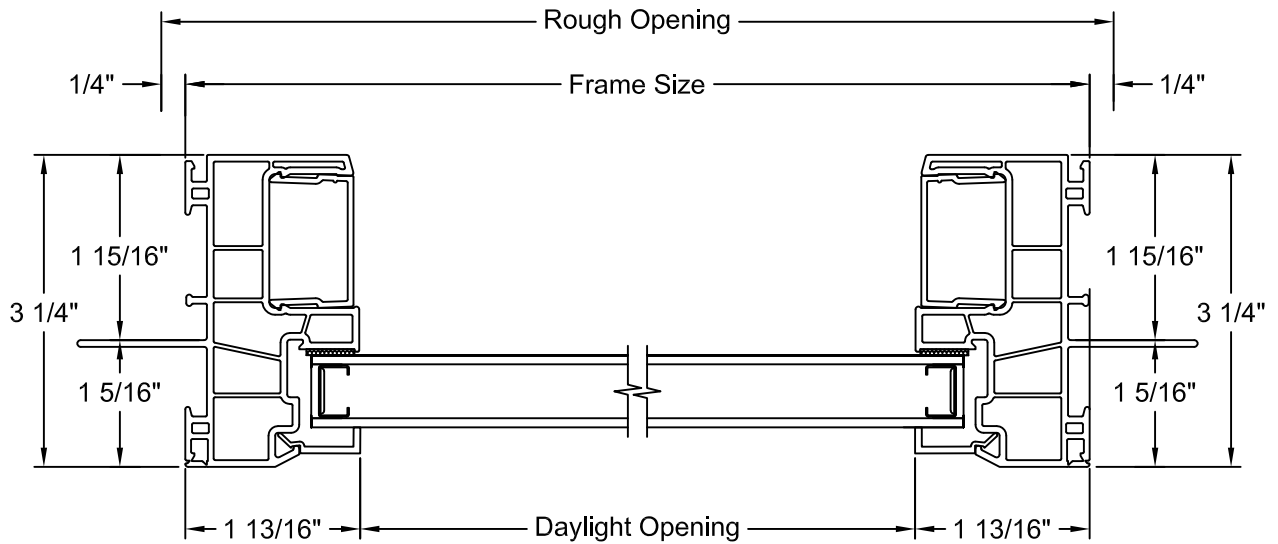



SLOPE SILL - VERTICAL SECTION

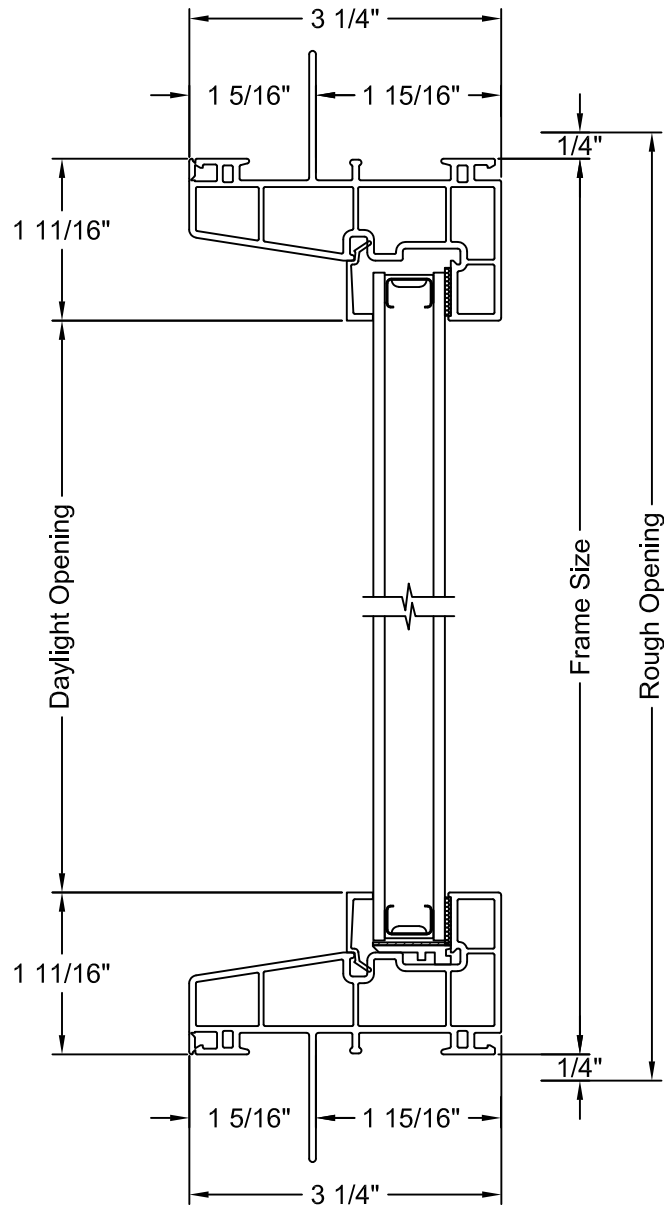



SLOPE SILL - HORIZONTAL SECTION

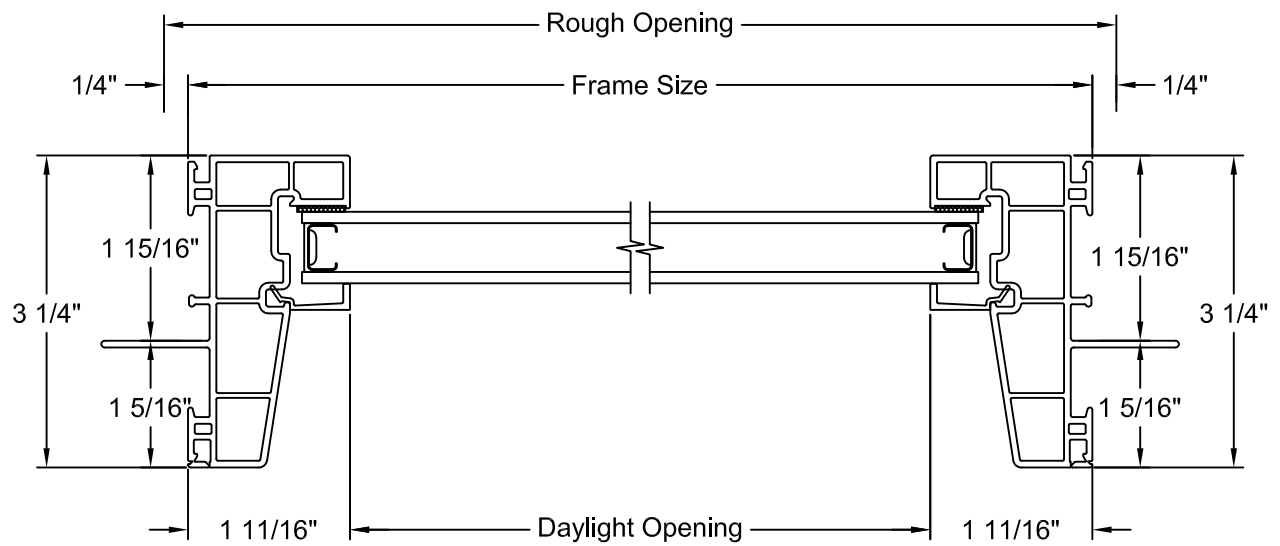



FLUSH FIN GEOMETRIC - VERTICAL SECTION

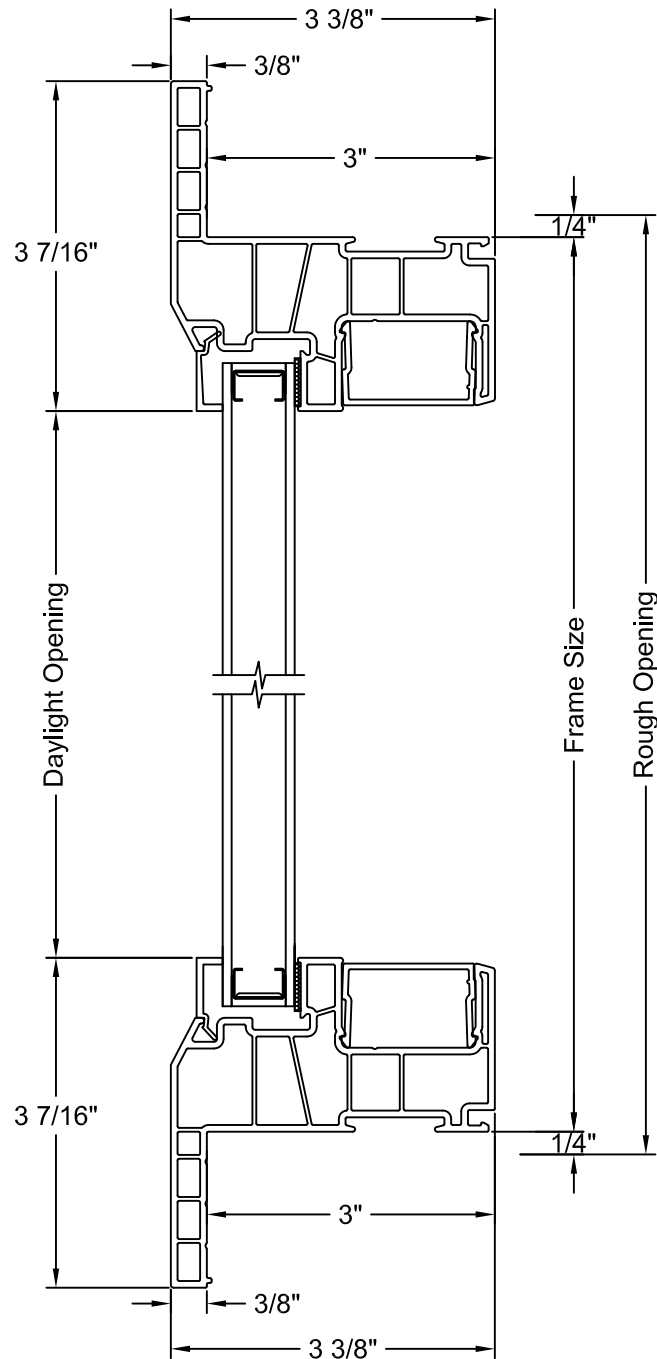



FLUSH FIN GEOMETRIC - HORIZONTAL SECTION

