

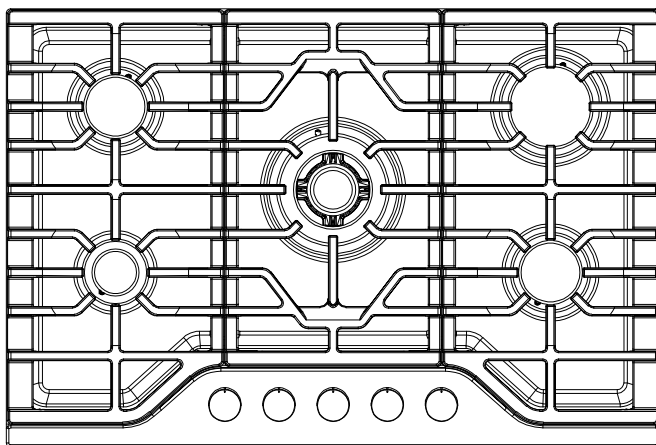

# **GAS COOKTOP**

**COS-CTGV305SS**

**COS-CTGV365SS**



## **DROP-IN COOKTOP SERIES**

### **INSTALLATION & USER MANUAL**

**IMPORTANT:** READ AND SAVE THESE INSTRUCTIONS.  
FOR RESIDENTIAL USE ONLY.

**INSTALLER:** PLEASE LEAVE THIS GUIDE WITH THE HOMEOWNER.

**HOMEOWNER:** PLEASE KEEP THIS GUIDE FOR FUTURE REFERENCE.

# THANK YOU FOR YOUR PURCHASE

**Thank you for your purchase. We know that you have many brands and products to choose from and we are honored to know that you have decided to take one of our products into your home and hope that you enjoy it.**

COSMO Appliances are designed according to the strictest safety and performance standard for the North American market. We follow the most advanced manufacturing philosophy. Each appliance leaves the factory after thorough quality inspection and testing. Our distributors and our service partners are ready to answer any questions you may have regarding how to install, use and care for your products. We hope that this manual will help you learn to use the product in the safest and most effective manner.

**Before using this product, please read through this manual carefully.** Keep this user manual in a safe place for future reference. Please ensure that other persons using this product are familiar with these instructions as well.

If you have any questions or concerns, please contact the dealer from whom you purchased the product, or contact our Customer Support at:

**1-888-784-3108**

Reach us online at:

**[www.cosmoappliances.com](http://www.cosmoappliances.com)**

# TABLE OF CONTENTS

<b>COOKTOP SAFETY .....</b>	<b>4</b>
Important Safety Instructions .....	7
<b>INSTALLATION REQUIREMENTS .....</b>	<b>10</b>
Tools and Parts .....	10
Location Requirements .....	12
Product Dimensions .....	13
Clearances.....	15
Cutout Dimensions.....	16
Electrical Requirements.....	17
Gas Supply Requirements .....	18
<b>INSTALLATION INSTRUCTIONS.....</b>	<b>21</b>
Unpack Cooktop.....	21
Install Cooktop.....	22
Gas Connection .....	23
Complete Connection .....	25
Adjust Flame Height .....	27
<b>GAS CONVERSION.....</b>	<b>29</b>
Convert Gas Pressure Regulator .....	29
Convert Surface Burners.....	31
Complete Gas Conversion.....	33
<b>OVERVIEW.....</b>	<b>34</b>
<b>COOKTOP USE .....</b>	<b>36</b>
Power Failure .....	37
Cookware .....	38
<b>COOKTOP CARE.....</b>	<b>39</b>
<b>TROUBLESHOOTING.....</b>	<b>41</b>
<b>LIMITED WARRANTY .....</b>	<b>43</b>

## COOKTOP SAFETY

### **WARNING**



#### **Fire Hazard**

If the information in this manual is not followed exactly, a fire or explosion may result causing property damage, personal injury or death.

- Do not store or use gasoline or other flammable vapors and liquids in the vicinity of this or any other appliance.
- **WHAT TO DO IF YOU SMELL GAS**
  - Do not try to light any appliance.
  - Do not touch any electrical switch.
  - Do not use any phone in your building.
  - Clear the room, building, or area of all occupants.
  - Immediately call your gas supplier from a neighbor's phone. Follow the gas supplier's instructions.
  - If you cannot reach your gas supplier, call the fire department.
- Installation and service must be performed by a qualified installer, service agency or the gas supplier.

### **WARNING**

Never Operate the Top Surface Cooking Section of this Appliance Unattended.

- Failure to follow this warning statement could result in fire, explosion, or burn hazard that could cause property damage, personal injury, or death.
- If a fire should occur, keep away from the appliance and immediately call your fire department.

**DO NOT ATTEMPT TO EXTINGUISH AN OIL/GREASE FIRE WITH WATER**

**WARNING:** Gas leaks cannot always be detected by smell.

Gas suppliers recommend that you use a gas detector approved by UL or CSA.

For more information, contact your gas supplier.

**WARNING:** Do not install a ventilation system that blows air downward toward this cooking appliance. This type of ventilation system may cause ignition and combustion problems with this cooking appliance resulting in personal injury or unintended operation.

### **Your safety and the safety of others are very important.**

We have provided many important safety messages in this manual and on your appliance. Always read and obey all safety messages.



This is the safety alert symbol.

This symbol alerts you to potential hazards that can kill or hurt you and others.

All safety messages will follow the safety alert symbol and either the word "DANGER," "WARNING" or "CAUTION." These words mean:

 **DANGER**

You can be killed or seriously injured if you don't immediately follow instructions.

 **WARNING**

You can be killed or seriously injured if you don't follow instructions.

 **CAUTION**

A potentially hazardous situation which, if not avoided, could result in minor or moderate injury.

All safety messages will tell you what the potential hazard is, tell you how to reduce the chance of injury, and tell you what can happen if the instructions are not followed.

In the State of Massachusetts, the following installation instructions apply:

- Installations and repairs must be performed by a qualified or licensed contractor, plumber, or gasfitter qualified or licensed by the State of Massachusetts.
- If using a ball valve, it shall be a T-handle type.
- A flexible gas connector, when used, must not exceed 3 feet.

California Proposition 65 Warning

 **WARNING:**

Cancer and Reproductive Harm - [www.P65Warnings.ca.gov](http://www.P65Warnings.ca.gov).

# IMPORTANT SAFETY INSTRUCTIONS

**WARNING:** To reduce the risk of fire, electrical shock, injury to persons, or damage when using the cooktop, follow basic precautions, including the following:

- **WARNING:** NEVER use this appliance as a space heater to heat or warm the room. Doing so may result in carbon monoxide poisoning and overheating of the oven.
- Do not touch any part of the cooktop, including but not limited to cooktop burners during or immediately after cooking.
- **CAUTION:** Do not store items of interest to children in cabinets above the cooktop – children climbing on the cooktop to reach items could be seriously injured.
- Do Not Leave Children Alone – Children should not be left alone or unattended in area where appliance is in use. They should never be allowed to sit or stand on any part of the appliance.
- Wear Proper Apparel – Loose-fitting or hanging garments should never be worn while using the appliance.
- User Servicing – Do not repair or replace any part of the appliance unless specifically recommended in the manual. All other servicing should be referred to a qualified technician.
- Storage in or on appliance – Flammable materials should not be stored in an oven or near surface units.
- Do Not Use Water on Grease Fires – Smother fire or flame or use dry chemical or foam-type extinguisher.
- Use Only Dry Potholders – Moist or damp potholders on hot surfaces may result in burns from steam. Do not let potholder touch hot surface units. Do not use a towel or other bulky cloth.
- Never Leave Surface Units Unattended at High Heat Settings – Boilover causes smoking and greasy spillovers that may ignite.
- Glazed Cooking Utensils – Only certain types of glass, glass/ceramic, ceramic, earthenware, or other glazed utensils are suitable for range-top service without breaking due to the sudden change in temperature.

**READ AND SAVE THESE INSTRUCTIONS**

# IMPORTANT SAFETY INSTRUCTIONS

- **Utensil Handles Should Be Turned Inward and Not Extend Over Adjacent Surface Units** – To reduce the risk of burns, ignition of flammable materials, and spillage due to unintentional contact with the utensil, the handle of a utensil should be positioned so that it is turned inward, and does not extend over adjacent surface units.
- Make sure the cooktop hold-down brackets are properly installed.
- Disconnect the electrical supply before servicing.
- Do not use replacement parts that have not been recommended by the manufacturer (e.g. parts made at home using a 3D printer).
- **Clean Cooktop With Caution** – If a wet sponge or cloth is used to wipe spills on a hot cooking area, be careful to avoid steam burn. Some cleaners can produce noxious fumes if applied to a hot surface.
- **Do Not Heat Unopened Food Containers** – Build-up of pressure may cause container to burst and result in injury.
- **Proper Installation** – The appliance, when installed, must be electrically grounded in accordance with local codes, or in the absence of local codes, with the National Electrical Code, ANSI/NFPA 70 or the Canadian Electrical Code, CSA C22.1-02. In Canada, the appliance must be electrically grounded in accordance with Canadian Electrical Code. Be sure your appliance is properly installed and grounded by a qualified technician.
- This cooktop is equipped with a three-prong grounding plug for your protection against shock hazard and should be plugged directly into a properly grounded receptacle. Do not cut or remove the grounding prong from this plug.
- Disconnect the electrical supply before servicing.
- Injuries may result from misuse of the cooktop such as stepping, leaning, or sitting on the top surface.
- **Maintenance** – Keep cooktop area clear and free from combustible materials, gasoline, and other flammable vapors and liquids.

**READ AND SAVE THESE INSTRUCTIONS**

# IMPORTANT SAFETY INSTRUCTIONS

- Do not let cooking grease or other flammable materials accumulate on the cooktop. Grease on the cooktop may ignite.
  - Top burner flame size should be adjusted so it does not extend beyond the edge of the cooking utensil. This instruction is based on safety considerations.
  - Have the installer show you the location of the cooktop gas shut-off valve and how to turn it off if necessary.
  - Proper Disposal of Your Appliance – Dispose of or recycle your appliance in accordance with Federal and Local Regulations. Contact your local authorities for the environmentally safe disposal or recycling of your appliance.
- For units with ventilating hoods:**
- Clean Ventilating Hoods Frequently – Grease should not be allowed to accumulate on hood or filter.
  - When flaming foods under the hood, turn the fan on.

**READ AND SAVE THESE INSTRUCTIONS**

# INSTALLATION REQUIREMENTS

## TOOLS AND PARTS

Gather the required tools and parts before starting installation. Read and follow the instructions provided with any tools listed here.

### Tools Needed

- Tape measure
- Flat-blade screwdriver
- Phillips screwdriver
- Wrench or pliers
- Pipe wrench
- 15/16" (2.4 cm) combination wrench
- Marker or pencil
- Pipe-joint compound resistant to Propane gas
- Noncorrosive leak-detection solution

### For Propane/Natural Gas Conversions

- 1/2" (1.3 cm) combination wrench
- 1/4" (6 mm) nut drive
- 9/32" (7 mm) nut drive
- Masking tape

### Parts Supplied

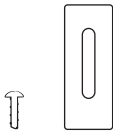

Hold-down bracket with screws (4 sets)

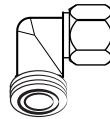

Gas Inlet Pipe Adapter (1)



Rubber Gasket (1)

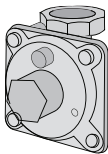

Gas pressure regulator (1)

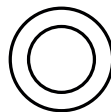

Washers (3)

## Parts Needed



Gas supply line kit  
(supply line and 2 adapters)

## Optional Parts

To purchase these or any other accessories, please visit [www.cosmoappliances.com](http://www.cosmoappliances.com) or reference the contact information at the end of this manual.

- Replacement NG/LP conversion kit



Scan to find  
available NG/LP  
kits

# LOCATION REQUIREMENTS

**IMPORTANT:** Observe all governing codes and ordinances. Do not obstruct flow of combustion and ventilation air.

- This cooktop is for indoor household use only.
- It is the installer's responsibility to comply with installation clearances specified on the model/serial rating plate. The model/serial rating plate is located on the underside of the cooktop base.
- The cooktop should be installed in a location away from strong draft areas, such as windows, doors, and strong heating vents or fans.
- All openings in the wall or floor where cooktop is to be installed must be sealed.
- Cabinet opening dimensions that are shown must be used.
- Grounded electrical supply is required. See "Electrical Requirements" section.
- Proper gas supply connection must be available. See "Gas Supply Requirements" section.
- The cooktop is designed to hang from the countertop by its side or rear flanges.
- The gas and electric supply should be accessible without requiring removal of the cooktop.

**IMPORTANT:** To avoid damage, check with your builder or cabinet supplier to make sure that the materials used will not discolor, delaminate or sustain other damages.

## Mobile Home - Additional Installation Requirements

- The installation of this cooktop must conform to the Manufactured Home Construction and Safety Standard, Title 24 CFR, Part 3280 (formerly the Federal Standard for Mobile Home Construction and Safety, Title 24, HUD Part 280). When such standard is not applicable, use the Standard for Manufactured Home Installations, ANSI A225.1/NFPA 501A or with local codes.

In Canada, the installation of this cooktop must conform with the current standards CAN/CSA-Z240-latest edition, or with local codes.

# PRODUCT DIMENSIONS

**Note:** Cooktop features may differ.

**COS-CTGV305SS**

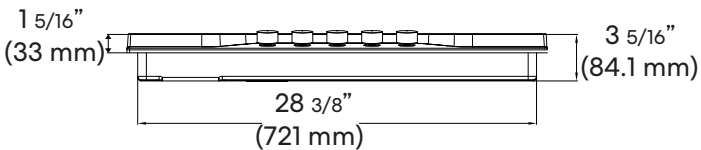
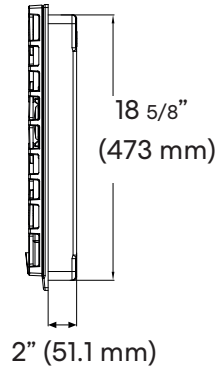
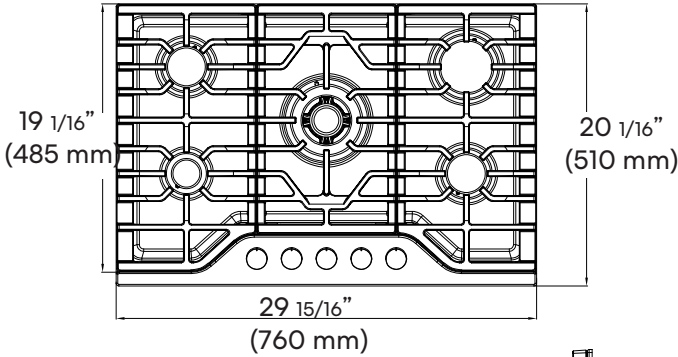
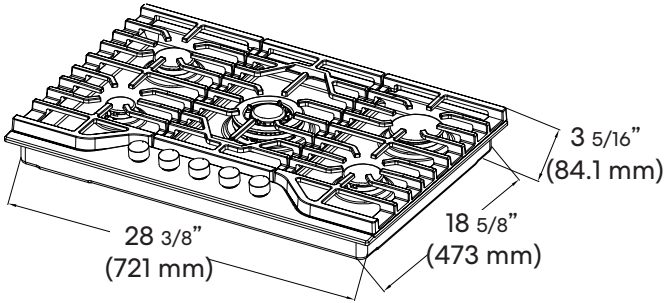

# PRODUCT DIMENSIONS

**Note:** Cooktop features may differ.

**COS-CTGV365SS**

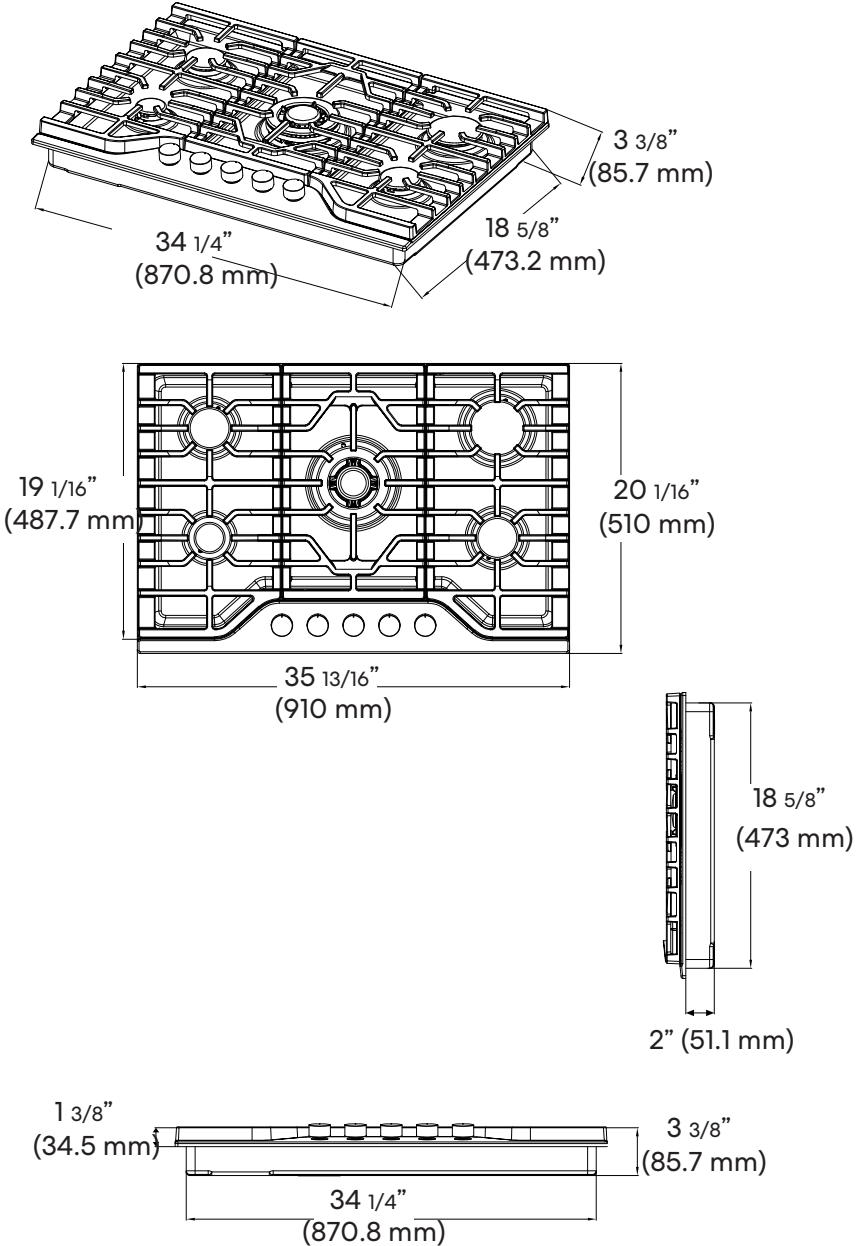

# CLEARANCES

**IMPORTANT:** Some cabinet and building materials are not designed to withstand the heat produced by the cooktop. Check with your builder or cabinet supplier to make sure that the materials used will not discolor, delaminate or sustain other damage.

**GIVEN DIMENSIONS ARE MINIMUM CLEARANCES.**

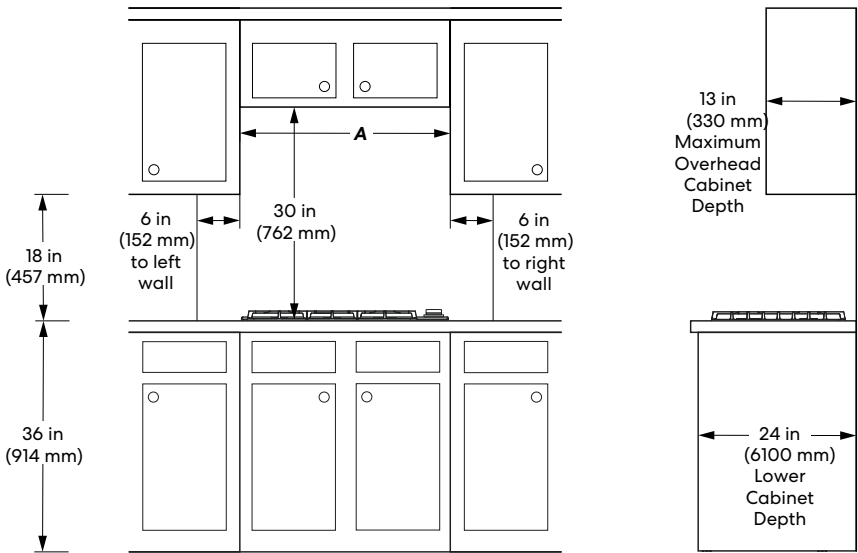

MODEL	A
COS-CTGV305SS	30" (762 mm)
COS-CTGV305SS	36" (914 mm)

**NOTE:**

- 30" (762 mm) minimum clearance between cooking surface and bottom of the overhead cabinet.  
**IMPORTANT:** If installing a range hood, hood liner, or microware hood combination above the cooking surface, follow the range hood or microwave hood combination installation instructions for dimensional clearances above the cooktop surface.
- 18" (457 mm) minimum clearance from upper cabinet to countertop on either side of unit.

# CUTOUT DIMENSIONS

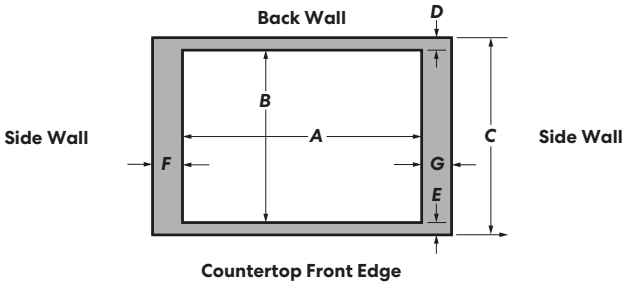

MODEL	A			B		
	Min	Recommended	Max	Min	Recommended	Max
COS-CTGV305SS	28 <sup>9</sup> / <sub>16</sub> " (726 mm)	<b>29"</b> <b>(736 mm)</b>	29 <sup>3</sup> / <sub>8</sub> " (746 mm)	19 <sup>1</sup> / <sub>4</sub> " (489 mm)	<b>19 <sup>3</sup>/<sub>4</sub>"</b> <b>(501 mm)</b>	20 <sup>3</sup> / <sub>16</sub> " (513 mm)
COS-CTGV365SS	34 <sup>9</sup> / <sub>16</sub> " (878 mm)	<b>34 <sup>15</sup>/<sub>16</sub>"</b> <b>(889 mm)</b>	35 <sup>3</sup> / <sub>8</sub> " (898 mm)			

MODEL	Back Wall and Countertop Front			Side Walls (Combustible Surfaces)	
	C	D	E	F	G
COS-CTGV305SS	24" (610 mm)	2.5" (635 mm)	2.5" (635 mm)	6" (152 mm)	6" (152 mm)
COS-CTGV365SS					

## NOTE:

- After making the countertop cutout, some installations may require notching down the base cabinet side walls to clear the cooktop base. To avoid this modification, use a base cabinet with sidewalls wider than the cutout.
- If a built-in wall oven is to be installed below this cooktop, the grounded outlet and gas supply piping must be located in an adjacent cabinet. If installing a range hood or microwave hood combination above the cooking surface, follow the range hood or microwave hood combination installation instructions for dimensional clearances above the cooktop.
- This cooktop and its gas and electrical supply sources must be installed before the undercounter built-in wall oven is installed.

# ELECTRICAL REQUIREMENTS

## **WARNING**



### **Electrical Shock Hazard**

Plug into a grounded 3 prong outlet.

Do not remove ground prong.

Do not use an adapter or extension cord.

Failure to do so can result in death, fire or electrical shock.

**IMPORTANT:** The cooktop must be electrically grounded in accordance with local codes and ordinances, or in the absence of local codes, with the National Electrical Code, ANSI/NFPA 70 or Canadian Electrical Code, CSA C22.1.

Do not ground the cooktop to any gas line or gas pipe.

This cooktop is equipped with an electronic ignition system that will not operate if plugged into an outlet that is not proper polarized.

If codes permit and a separate ground wire is used, it is recommended that a qualified electrical installer determine that the ground path is adequate and wire gauge is in accordance with local codes.

A copy of the above code standards can be obtained from:

National Fire Protection Association  
1 Batterymarch Park  
Quincy, MA 02169-7471

CSA International  
8501 East Pleasant Valley Road  
Cleveland, OH 44131-5575

A 120 V, 60 Hz, AC only, 15 A, fused electrical circuit is required. A time-delay fuse or circuit breaker is also recommended. It is recommended that a separate circuit serving only this cooktop is provided.

Electronic ignition systems operate within wide voltage limits, but proper grounding and polarity are necessary. Check that the outlet provides 120 V power and is correctly grounded.

**WARNING:** Improper connection of the equipment-grounding conductor can result in a risk of electric shock. Check with a qualified electrician or service technician if you are in doubt as to whether the appliance is properly grounded. Do not modify the power supply cord plug. If it will not fit the outlet, have a proper outlet installed by a qualified electrician.

## GAS SUPPLY REQUIREMENTS

### **WARNING**



#### **Explosion Hazard**

Use a new CSA International approved gas supply line and install a shut-off valve for new installations.

Securely tighten all gas connections.

If connected to LP, have a qualified person make sure gas pressure does not exceed the maximum pressure listed in this section.

Examples of a qualified person include:

- licensed heating personnel,
- authorized gas company personnel, and
- authorized service personnel.

Failure to do so can result in death, explosion or fire.

### **IMPORTANT:**

- Observe all governing codes and ordinances.
- This installation must conform with all local codes and ordinances. In the absence of local codes, installation must conform with National Fuel Gas Code, ANSI Z223.1/NFPA 54 or, in Canada, the Natural Gas and Propane Installation Code, CSA B149.1 - latest edition.
- Cooktop must be connected to a regulated gas supply.

- Leak testing of the cooktop must be conducted according to the manufacturer's instructions.

## TYPE OF GAS

### Natural Gas:

This cooktop is factory-set for use with Natural gas. The model/serial rating plate located on the underside of the cooktop base has information on the types of gas that can be used. If the types of gas listed do not include the type of gas available, check with the local gas supplier.

### LP Gas Conversion:

Conversion must be performed by a qualified service technician. The qualified agency performing this work assumes the gas conversion responsibility.

No attempt shall be made to convert the appliance from the gas specified on the model/serial rating plate for use with a different gas without consulting the serving gas supplier. See "GAS CONVERSION" section.

## GAS SUPPLY LINE

Provide a gas supply line of 3/4" (19 mm) rigid pipe to the cooktop location. A smaller size pipe on longer runs may result in insufficient gas supply. Pipe-joint compounds that resist the action of LP gas must be used. With LP gas, piping or tubing size can be 1/2" (13 mm) minimum. Usually, LP gas suppliers determine the size and materials used in the system.

**IMPORTANT:** All connections must be wrench-tightened. Do not make connections to the gas pressure regulator too tight. Making the connections too tight may crack the regulator and cause a gas leak. Do not allow the regulator to turn or move when tightening fittings.

### Flexible metal appliance connector:

- If local codes permit, a new CSA design-certified, 4 - 5 ft (122 - 1524 mm) long, 1/2" (13 mm) or 3/4" (19 mm) I.D., flexible metal appliance connector may be used for connecting cooktop to the gas supply line.



- A 1/2" (13 mm) male pipe thread is needed for connection to the female pipe threads of the inlet to the appliance pressure regulator.
- Do not kink or damage the flexible metal tubing when moving the cooktop.

### Rigid pipe connection:

The rigid pipe connection requires a combination of pipe fittings to obtain an in-line connection to the cooktop. The rigid pipe must be level with the cooktop connection. All strains must be removed from the supply and fuel lines so cooktop will be level and in line.

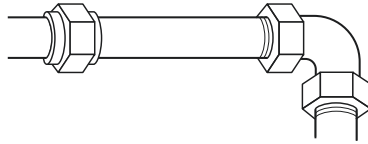

### Gas shutoff valve:

A manual gas line shut-off valve must be installed in an easily accessible location. Do not block access to shut-off valve. The valve is for turning on or shutting off gas to the cooktop.

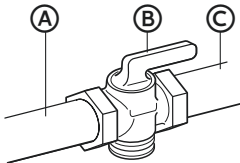

- (A) Gas supply line
- (B) Shutoff valve "open" position
- (C) To cooktop

## GAS PRESSURE REGULATOR

The gas pressure regulator supplied with this cooktop must be used. The inlet pressure to the regulator should be as follows for proper operation:

TYPE OF GAS	SUPPLY PRESSURE
Natural gas	5" WCP
LP gas	10" WCP

Contact local gas supplier if you are not sure about the inlet pressure.

### Burner Input Requirements

Input ratings shown on the model/serial rating plate are for elevations up to 2,000 ft (609.6 m).

For elevations above 2,000 ft (609.6 m), ratings are reduced at a rate of 4% for each 1,000 ft (304.8 m) above sea level (not applicable for Canada).

## GAS SUPPLY PRESSURE TESTING

Gas supply pressure for testing regulator must be at least 1" (2.5 cm) water column pressure above the manifold pressure shown on the model/serial rating plate.

### Line pressure testing above 0.5 psi gauge (14" WCP)

The cooktop and its individual shutoff valve must be disconnected from the gas supply piping system during any pressure testing of that system at test pressures in excess of 0.5 psi (3.5 kPa).

### Line pressure testing at 0.5 psi gauge (14" WCP) or lower

The cooktop must be isolated from the gas supply piping system by closing its individual manual shutoff valve during any pressure testing of the gas supply piping system at test pressures equal to or less than 1/2 psi (3.5 kPa).

## INSTALLATION INSTRUCTIONS

**IMPORTANT:** This appliance shall be installed only by authorized persons and in accordance with the manufacturer's installation instructions, local gas fitting regulations, municipal building codes, electrical wiring regulations, local water supply regulations.

## UNPACK COOKTOP

### **WARNING**

#### **Excessive Weight Hazard**

Use two or more people to move and install cooktop.  
Failure to do so can result in back or other injury.

1. Remove shipping materials, tape and film from the cooktop. Do not dispose of anything until the installation is complete.
2. Set aside the surface burners and grates if they are not pre-installed.

# INSTALL COOKTOP

1. Determine whether your cabinet construction provides clearance for installing hold-down brackets at cooktop base ends.

2. Using two or more people, place cooktop right side up into the cutout.

**Note:** Make sure that the front edge of the cooktop is parallel to the front edge of the counter top. If repositioning is needed, lift entire cooktop up from cutout to avoid scratching the countertop.

3. Attach hold-down brackets to cooktop base bottom with the screws supplied. Securely tighten screws.

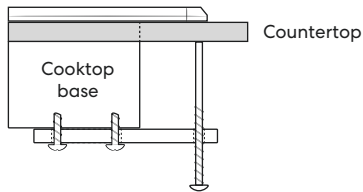

# GAS CONNECTION

## WARNING



### Explosion Hazard

Use a new CSA International approved gas supply line and install a shut-off valve for new installations.

Securely tighten all gas connections.

If connected to LP, have a qualified person make sure gas pressure does not exceed the maximum pressure listed in the "Gas Supply Requirement" section.

Examples of a qualified person include:

- licensed heating personnel,
- authorized gas company personnel, and
- authorized service personnel.

Failure to do so can result in death, explosion or fire.

This appliance shall be installed only by authorized persons and in accordance with the manufacturer's installation instructions, local gas fitting regulations, municipal building codes, electrical wiring regulations, local water supply regulations.

This cooktop is factory-set for use with Natural gas. To use this cooktop with Propane gas, see the "Gas Conversions" section before connecting this cooktop to the gas supply. Gas conversions from Natural gas to Propane gas or from Propane gas to Natural gas must be done by a qualified installer.

## TYPICAL FLEXIBLE CONNECTION

The following shows a typical connection. Your connection may be different according to the supply line type, size, and location.

1. Make sure the gas line shut-off valve is close.
2. Apply pipe-joint compound made for use with Natural and LP gas to the smaller thread ends of the flexible connector adapters.

- Attach one adapter to the gas pressure regulator and the other adapter to the gas shutoff valve. Tighten both adapters, being certain not to move or turn the gas pressure regulator.

**Note:** Install the gas pressure regulator with the arrow pointing in the direction toward the bottom of the cooktop base and in a position where you can reach the regulator access cap.

- Use a 15/16" (24 mm) combination wrench and channel lock pliers to attach the flexible connector to the adapters. Check that connector is not kinked.

#### No obstructions below cooktop

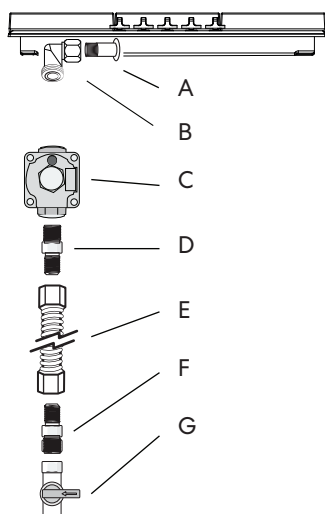

- A. Manifold entrance
- B. Gas Inlet Pipe Adapter
- C. Gas pressure regulator
- D. Flare union adapter
- E. Flexible connector
- F. Flare union adapter
- G. Manual gas shutoff valve

#### Suggested installation to avoid interference below cooktop

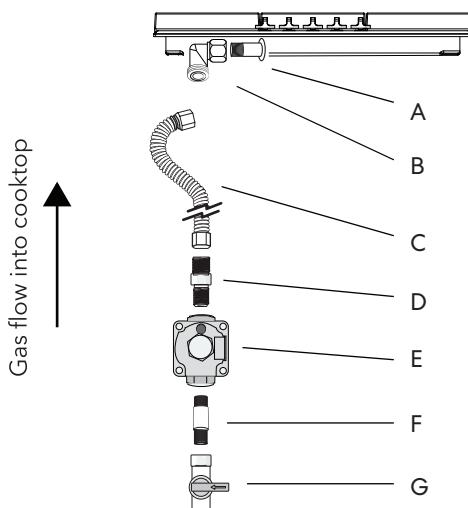

- A. Manifold entrance
- B. Gas Inlet Pipe Adapter
- C. Flexible connector
- D. Flare union adapter
- E. Gas pressure regulator
- F. 1/2" (13 mm) or 3/4" (19 mm) gas pipe
- G. Manual gas shutoff valve

## CONVERT TO LP GAS (OPTIONAL)

This cooktop is shipped from the factory set up to use natural gas. It can be converted to use LP gas by a qualified service technician.

The LP conversion kit (LP orifices) is included. The conversion to LP requires all surface burner orifices to be changed. In addition, the nozzle on the gas pressure regulator needs to be reversed.

See "GAS CONVERSION" section for detailed instructions.

**NOTE:** All replaced orifices must be left with the consumer, including the instructions and retrofit sizes and orifice indication.

## COMPLETE CONNECTION

### **WARNING**



#### **Electrical Shock Hazard**

Disconnect power before servicing.

Plug into a grounded 3-prong outlet.

Do not use an adapter or an extension cord.

Failure to do so can result in death, fire, or electrical shock

1. Open the manual shutoff valve in the gas supply line. The valve is open when the handle is parallel to the gas pipe.
2. Test all connections by brushing on an approved noncorrosive leak-detection solution. If bubbles appear, a leak is indicated. Correct any leak found.
3. Remove, if any, packaging tapes securing the burners on the surface. If the cooktop burner bases and caps are not pre-installed, remove them from package containing parts, align and place the burner bases and caps accordingly.

**Note:** Align notches in burner caps with pins in burner base. Burner caps should be level when properly positioned. If burner caps are not properly positioned, surface burners will not light.

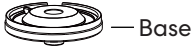

Standard burner

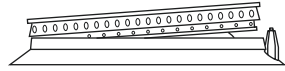

Incorrectly positioned

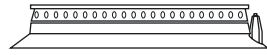

Correctly positioned

4. Place burner grates over burners and caps.
5. Plug in cooktop or reconnect power.

## ADJUST FLAME HEIGHT

Check and adjust the height of top burner flames. The cooktop "low" burner flame should be a steady blue flame approximately 1/4" (6 mm) high. Propane gas flames have a slightly yellow tip.

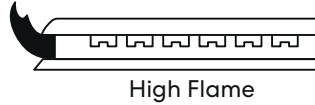
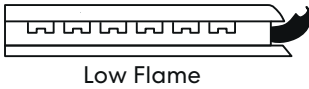

### If burners do not light properly:

1. Turn burner control knob to the "OFF" position.
2. Check that the cooktop is plugged in. Check that the circuit breaker has not tripped or the household fuse has not blown.
3. Check that the gas shutoff valves are set to the "open" position.
4. Check that burner caps are properly positioned on burner bases.

### To adjust standard burner:

**IMPORTANT:** Adjustments must be made with two other burners in operation on a medium setting. This prevents the upper row of flames from being set too low, resulting in the flame being extinguished when other burners are turned on.

The flame can be adjusted using the adjustment screw in the center of the valve stem. The valve stem is located directly behind the control knob.

1. Light the burner and turn the knob to the lowest setting (MIN).
2. Pull and remove the control knob.
3. Insert a small, flat-blade screwdriver into the adjustment screw, and slowly turn the screw until the flame appearance is correct.
  - Open the valve more if the flames are too small or fluttered.
  - Close the valve more if the flames are too large.

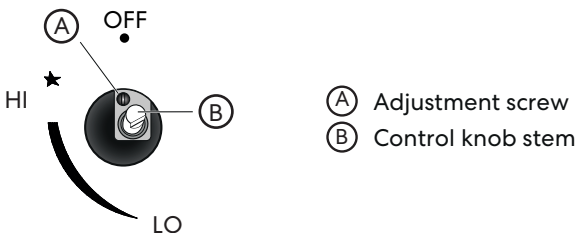

4. Replace the control knob.
5. Test and check the flame by turning the control knob from the lowest to the highest settings.

**NOTE:** For burners (on some models) with safety valve, make sure that the regulation obtained is sufficient to maintain heating of the thermocouple. If it is not, increase the minimum flame.

## **ABNORMAL OPERATION**

**ANY OF THE FOLLOWING ARE CONSIDERED TO BE ABNORMAL OPERATION AND MAY REQUIRE SERVICING:**

- Yellow tipping of the hob burner flame
- Sooting up of cooking utensils.
- Burners not igniting properly.
- Burners failing to remain lit.
- Burners extinguished by oven door.
- Gas valves, which are difficult to turn.

**IN CASE THE APPLIANCE FAILS TO OPERATE CORRECTLY, CONTACT THE AUTHORIZED SERVICE PROVIDER IN YOUR AREA.**

**THE BURNERS REQUIRE NO REGULATION OF THE PRIMARY AIR.**

# GAS CONVERSION

## WARNING



### Explosion Hazard

Use a new CSA International approved gas supply line.

Install a shut-off valve.

Securely tighten all gas connections.

If connected to LP, have a qualified person make sure gas pressure does not exceed the maximum pressure listed in the "Gas Supply Requirement" section.

Examples of a qualified person include:

- licensed heating personnel,
- authorized gas company personnel, and
- authorized service personnel.

Failure to do so can result in death, explosion or fire.

## LP/PROPANE GAS CONVERSION

**IMPORTANT:** Gas conversions must be done by a qualified service technician in accordance with the manufacturer's instructions and all codes and requirements of the authority having jurisdiction. The qualified agency performing this work assumes the gas conversion responsibility.

### Convert Gas Pressure Regulator

1. Turn manual shutoff valve to the closed position.
2. Unplug cooktop or disconnect power.
3. Locate the gas pressure regulator below the cooktop.

**IMPORTANT:** Do not remove the gas pressure regulator.

**4. Unscrew the regulator cap with the wrench.**

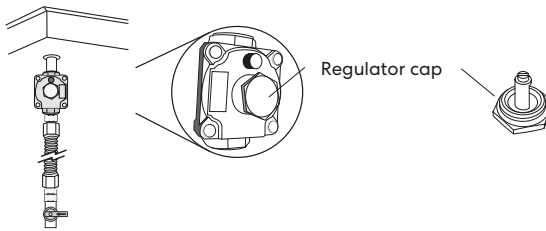

**5. Remove the retainer pin that is currently positioned for use with natural gas.**

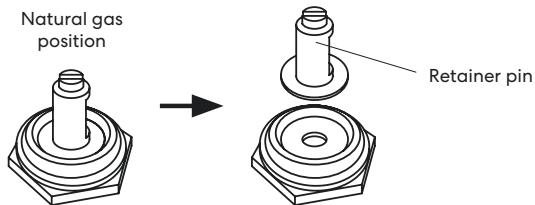

**6. Turn the retainer pin upside down and place it back into the regular cap. The regular cap is now positioned for use with LP gas.**

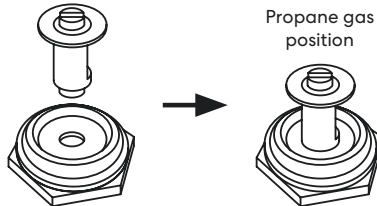

**7. Screw and tighten the regulator cap back into the gas pressure regulator with the wrench.**

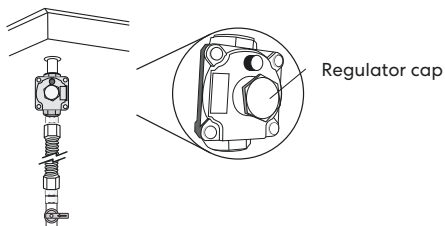

## Convert Surface Burners

1. If installed, remove the burner grates.
2. Remove the burner grates, burner caps, and the burner base.

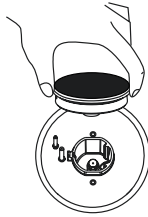

3. Remove the natural gas orifices with a 9/32" (7 mm) nut driver.

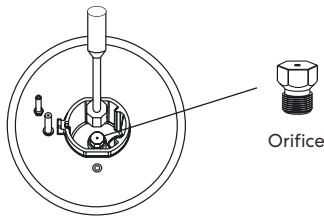

4. Replace the natural gas orifices with the correct LP gas orifices from the LP conversion kits. LP gas orifices are stamped with a size. Refer to the following chart for correct LP gas orifice ratings and sizes for proper placement.

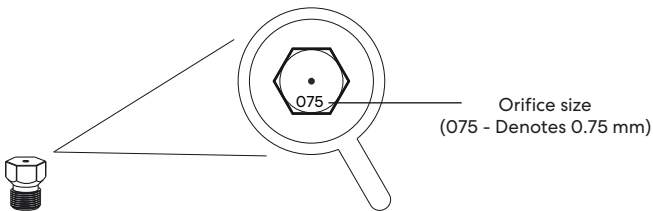

**Orifice Chart for Surface Burners:**  
**COS-CTGV305SS and COS-CTGV365SS**

Placement	LP Orifice Size (mm)	NG Orifice Size (mm)	Burner Rating
Front Left	0.57	0.81	3,400 BTU
Front Right	0.75	1.13	6,000 BTU
Rear Left	0.75	1.13	6,000 BTU
Rear Right	0.96	1.43	10,000 BTU
Center	Inner: 0.6 Outer: 1.29	Inner: 0.95 Outer: 2.4	22,000 BTU

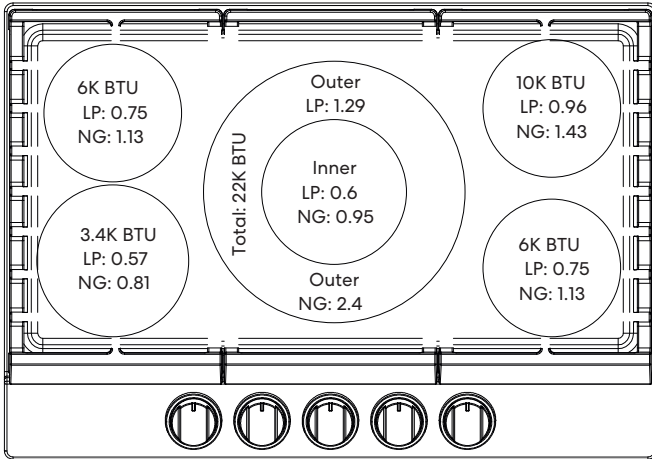

LP and NG Orifices are in size (mm)

5. Keep and store natural gas orifices in case of re-installation with natural gas.
6. Replace the burner base, the burner caps, and the burner grates.

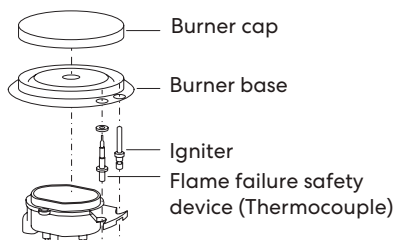

### Complete Gas Conversion

1. Open shutoff valve in the gas supply line.
  2. Plug in cooktop or reconnect power.
- Refer to "Gas Connection" section in the "Installation Instructions" section for proper connection of the cooktop to the gas supply.
  - Refer to "Complete Connection" section to complete this procedure.
  - Refer to the "Adjust Flame Height" section for burner flame adjustments.
- IMPORTANT:** You may have to adjust the low setting for each cooktop burner.

# OVERVIEW

## COOKTOP LAYOUT

This illustration covers several different models. The cooktop you have purchased may have some or all of the items listed. The locations and appearances of the features shown here may not match those of your model.

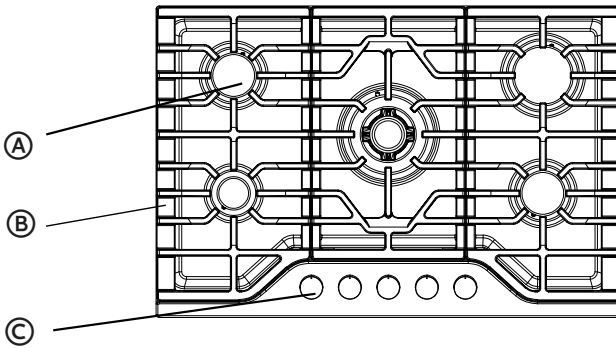

- Ⓐ Surface burner
- Ⓑ Grate
- Ⓒ Burner control knob

## WHAT'S INCLUDED

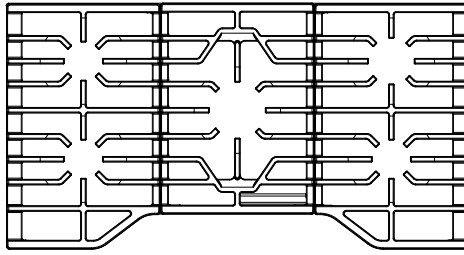

Surface burner grates (3)  
Model: COS-CTGV305SS and COS-CTGV365SS

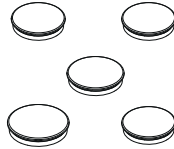

Surface burners and caps (5)  
Model: COS-CTGV305SS and COS-CTGV365SS

## BURNER LAYOUT

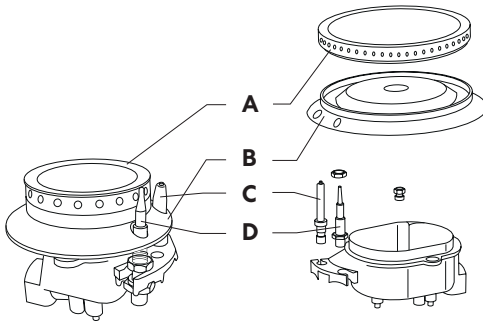

- A.** Burner cap
- B.** Burner head

- C.** Electrode
- D.** Flame failure safety device

## COOKTOP USE

Read the instructions before installing or using this appliance.

- This appliance shall be installed in accordance with the regulations in force and only used in a well-ventilated space.
- The use of a gas-cooking appliance results in the production of heat and moisture in the room in which it is installed. Ensure that the kitchen is well ventilated: keep natural ventilation holes open or install a mechanical ventilation device (mechanical extractor hood).
- Prolonged intensive use of the appliance may call for additional ventilation, for example opening of a window, or more effective ventilation, for example increasing the level of mechanical ventilation where present.
- Burners should be operated only when covered by cookware. Burner flames not covered by cookware present a risk of fire or clothing ignition.
- Never let flames extend beyond the sides of the cookware. Failure to comply may result in serious injury.
- Always turn off the surface burners before removing cookware. All surface burners should be turned off when you are not cooking.
- When removing hot cookware from the burner, be sure to lift it high enough to not come in contact with the control knobs. Hot cookware coming into contact with the control knobs could cause damage, such as melting or warping.
- If you smell gas, turn off the gas to the cooktop and call a qualified service technician. NEVER use an open flame to locate a leak.
- Do not operate the burner for an extended period of time without cookware on the grate. The finish on the grate may discolor or chip without cookware to absorb the heat.
- Do not attempt to disassemble any burner while another burner is on. Damage to the product may occur.
- Be sure the burners and grates are cool before you place your hand, a pot holder, or cleaning materials on them.

## USING THE COOKTOP BURNERS

**IMPORTANT:** Make sure all cooktop burners are properly installed.

1. To ignite a burner, push down on the burner control knob and turn it counter-clockwise towards the "HI" position. The clicking sounds indicate the system is igniting.
2. After the cooktop burner lights, release and turn the control knob between HI, Med, and Low to adjust the flame level.

**NOTE:** Flame failure safety device (Thermocouple) - Once the flame is lit, hold the control knob depressed for about 3-4 seconds until the device keeps the burner automatically lit. If the burner fails to ignite, wait one minute for the gas to dissipate before attempting to reignite.

3. To turn off the burner, turn the control knob to the OFF position.

## POWER FAILURE

In case of prolonged power failure, the surface burners can be lit manually with a match. Using extreme caution, hold a lit match near the ports beneath the surface burner cap, then push down on the burner control knob and slowly turn it counter-clockwise towards the "Hi" position. Once lit, release and turn the control knob to adjust the flame level, and surface burner will continue to operate normally.

### NOTES:

In the case of unintentional flame extinguishing, the safety valve intervenes by shutting off the gas to the burners.

The electric igniter must not be actuated for longer than 15 seconds. Should the burner not light, or should the burner be unintentionally turned off, immediately close the burner, and wait at least 1 minute before repeating. Once ignited, adjust the flame as desired.

For lower gas consumption and a better result, use saucepans with a diameter matching the diameter of the burner, to avoid the flame coming up around the sides of the saucepan. See the Container Table. Use only flat-bottomed pans.

As soon as liquid starts to boil, turn the flame down to a level sufficient to maintain boiling.

# COOKWARE

## MATCH PAN DIAMETER TO FLAME SIZE

The flame should be the same size as the bottom of the pan or smaller. Do not use small pans with high flame settings as the flames can lick up the sides of the pan. Oversize pans that span two burners are placed front to rear, not side to side.

## USE BALANCED PANS

Pans must sit level on the cooktop grate without rocking. Center the pan over the burner.

## USE A LID THAT FITS PROPERLY

A well-fitting lid helps shorten the cooking time. Flat, heavy bottom pans provide even heat and stability.

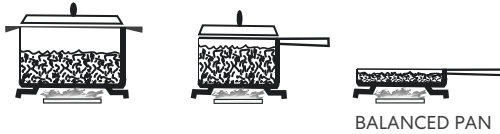

## CONTAINER TABLE

Burner	Min Saucepan	Max Saucepan
Front Left/Rear Left	3.5" (9.0 cm)	6.3" (16 cm)
Front Right	5.1" (13 cm)	7.1" (18 cm)
Rear Right	5.9" (15 cm)	10.2" (26 cm)
Center	8.3" (21 cm)	10.2" (26 cm)

# COOKTOP CARE

## CLEANING

**IMPORTANT:** Before cleaning, make sure all controls are off and the cooktop is cool. Always follow label instructions on cleaning products. Soap, water, and a soft cloth or sponge are suggested first, unless otherwise noted. Do not use abrasive cleaning products.

## CONTROL KNOBS

- To remove the knobs, be sure the knobs are in the OFF position.
- Pull knobs straight away from control panel to remove.

### **Cleaning Recommendation:**

- The knobs should be cleaned with soap and water.
- Do not clean knobs in the dishwasher or use abrasive cleaners or steel wool.
- Do not remove the seals under the knobs.

## BURNER GRATES

- To avoid chipping, do not bang grates against each other or hard surfaces, such as cast iron cookware. Although the grates are durable, they will gradually lose their shine due to exposure to high temperatures.

### **Cleaning Recommendation:**

- **Soap and Water:** Use a nonabrasive plastic scrubbing pad and mildly abrasive cleanser, soap, and water.
- **Dishwasher:** The grates may be cleaned in the dishwasher. Remove any burnt-on food prior to placing the grates in the lowest rack in the dishwasher.

## BURNER CAPS

- Do not place caps in the dishwasher or reassemble caps on burners when wet.

### **Cleaning Recommendation:**

- Use a nonabrasive plastic scrubbing pad and mildly abrasive cleanser, soap, and water.

## **BURNER BASE**

- The holes in the burner bases must be kept clean for proper ignition and a complete, even flame. Spillovers should be cleaned immediately since they can clog the openings in the burners.

**IMPORTANT:** Before cleaning, make sure all controls are OFF and the cooktop is cool.

### **Cleaning Recommendation:**

- Remove the burner cap from the base. Clean the burner cap with hot soapy water, and then rinse it.
- Remove the burner base and clean the gas tube opening under the base.
- Clean clogged burner ports with a straight pin, needle, or small-gauge wire as shown. Do not use a wooden toothpick or clean in the dishwasher.
- Gently clean the igniter with a damp cloth.

## **STAINLESS STEEL COOKTOP SURFACE**

- Food spills containing acids, such as vinegar and tomato, should be cleaned as soon the cooktop is cool. These spills may affect the finish.
- Do not use scouring pads, abrasive cleaners, cooktop cleaner, steel wool pads, gritty washcloths, or abrasive paper towels.

### **Cleaning Recommendation:**

- For best results, use a soft cloth or non-scratch sponge.
- Rub in direction of the grain to avoid damaging the surface.
- Use stainless steel or all-purpose cleaner.

## **PORCELAIN ENAMEL COOKTOP SURFACE (ON SOME MODELS)**

### **Cleaning Recommendation:**

- Use a nonabrasive scrubbing pad and glass cleanser or a mild liquid cleaner.

# TROUBLESHOOTING

First try the solutions suggested here to possibly avoid the cost of a service call.

## COOKTOP PROBLEMS

PROBLEM	POSSIBLE CAUSE	SOLUTION
<b>Burner will not ignite</b>	There is no power to the cooktop.	Make sure electrical plug is plugged into a live, properly grounded outlet. Replace the fuse or reset the circuit breaker.
	Burner parts or igniters may be wet, dirty, or misaligned.	Check that the burner parts and igniter are clean, dry, and correctly assembled.
<b>Burner will not operate</b>	Gas shut-off valve is close.	Open the gas shut-off valve.
	First time use. Air still in the gas line.	Turn on any one of the surface burner knobs to release air from the gas lines.
	Control knob is not set correctly.	Push in knob before turning to a setting.
	The burner port is clogged.	Clean burner port opening using a stiff, nylon toothbrush or a straightened paper clip.
<b>Burner Flames are uneven, yellow and/or noisy</b>	Burner port(s) are clogged.	Clean burner port opening using a stiff, nylon toothbrush or a straightened paper clip.
	Burner caps are not positioned properly.	Place burner caps so that the alignment pins are properly aligned with the slots.
	Propane gas is being used.	The cooktop should be converted to LP gas by a qualified technician.

<b>PROBLEM</b>	<b>POSSIBLE CAUSE</b>	<b>SOLUTION</b>
<b>Burner flame is too high or too low</b>	Cooktop gas supply is not correct.	Ensure the cooktop is set for the correct gas type. It is factory set for natural gas. If connecting to LP gas, the burners should be converted to LP gas with the orifice kit supplied and the pressure regulator converted to the LP gas setting by a qualified technician.
	The gas pressure is not correct.	Make sure the pressure regulator is installed correctly and the gas line pressure is correct. See Installation Instructions.
<b>Burner makes popping noises</b>	The burner is wet.	Allow the burner to dry before using.
	The burner cap or gas spreader is not positioned correctly.	Place burner caps so that the alignment pins are properly aligned with the slots.
<b>Excessive heat around cookware on cooktop</b>	The cookware is not the proper size for the burner.	Use cookware with a bottom surface approximately the same size as the cooking area and burner. Cookware should not extend more than 1" (2.5 cm) outside the cooking area. Adjust the flame so that it does not come up around the cookware.
<b>Cooking results are not what expected</b>	Using incorrect cookware.	See the "Cookware" section.
	The control knob is not set to the proper heat level.	See the "Adjust Flame Height" section.

# LIMITED WARRANTY

## WARRANTY AND SERVICE

TO RECEIVE WARRANTY SERVICE, YOUR PRODUCT MUST BE REGISTERED.

TO REGISTER AND REVIEW FULL WARRANTY DETAILS, VISIT:

**[WWW.COSMOAPPLIANCES.COM/WARRANTY](http://WWW.COSMOAPPLIANCES.COM/WARRANTY)**

SCAN TO REGISTER

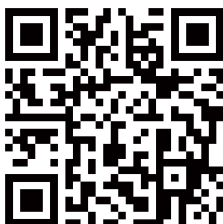

## CUSTOMER SUPPORT

TO CHAT WITH US LIVE FOR ASSISTANCE, VISIT:

**[WWW.COSMOAPPLIANCES.COM/CHAT](http://WWW.COSMOAPPLIANCES.COM/CHAT)**

SCAN TO CHAT



## **IMPORTANT**

### **Do Not Return This Product To The Store**

If you have a problem with this product, please contact COSMO Customer Support at

**+1 (888) 784-3108**

DATED PROOF OF PURCHASE, MODEL #, AND SERIAL # REQUIRED FOR WARRANTY SERVICE.

## **IMPORTANT**

### **Ne pas Réexpédier ce Produit au Magasin**

Pour tout problème concernant ce produit, veuillez contacter le service des consommateurs Cosmo Customer Support au

**+1 (888) 784-3108**

UNE PREUVE D'ACHAT DATEE EST REQUISE POUR BENEFICIER DE LA GARANTIE.

## **IMPORTANTE**

### **No regrese este producto a la tienda**

Si tiene algún problema con este producto, por favor contacte el ayuda al cliente COSMO al

**+1 (888) 784-3108**

(Válido solo en E.U.A.)

NECESITA UNA PRUEBA DE DE COMPRA FECHADA, NÚMERO DE MODELO Y DE SERIE PARA EL SERVICIO DE LA GARANTÍA.

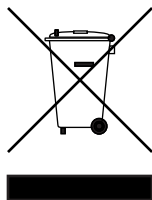

#### **Correct Disposal of this product:**

This marking indicates that this appliance should not be disposed with other household wastes. To prevent possible harm to the environment or human health from uncontrolled waste disposal, recycle it responsibly to promote the sustainable reuse of material resources.

# MEMO

A series of horizontal dashed lines for writing.

# MEMO

A series of horizontal dashed lines for writing.

# MEMO

A series of horizontal dashed lines for writing.



APPLIANCES

Cosmo is constantly making efforts to improve the quality and performance of our products, so we may make changes to our appliances without updating this manual.

Electronic version of this manual is available at:  
[www.cosmoappliances.com](http://www.cosmoappliances.com)