



# GAZEBO Penguin inc.

4660 HICKMORE ST,  
MONTREAL, QUEBEC  
H4T 1K2  
TEL: 1-514-276-3485, 1-800-737-7174

Email: [customerservice@gazebopenguin.com](mailto:customerservice@gazebopenguin.com)

**PLEASE READ  
IN ITS ENTIRETY  
BEFORE  
INSTALLATION**

**41218-12 SAND**  
**41218-32 SLATE**  
**12 X 18 SOLARIUM**

**PLEASE READ  
IN ITS ENTIRETY  
BEFORE  
INSTALLATION**

## ASSEMBLY INSTRUCTIONS

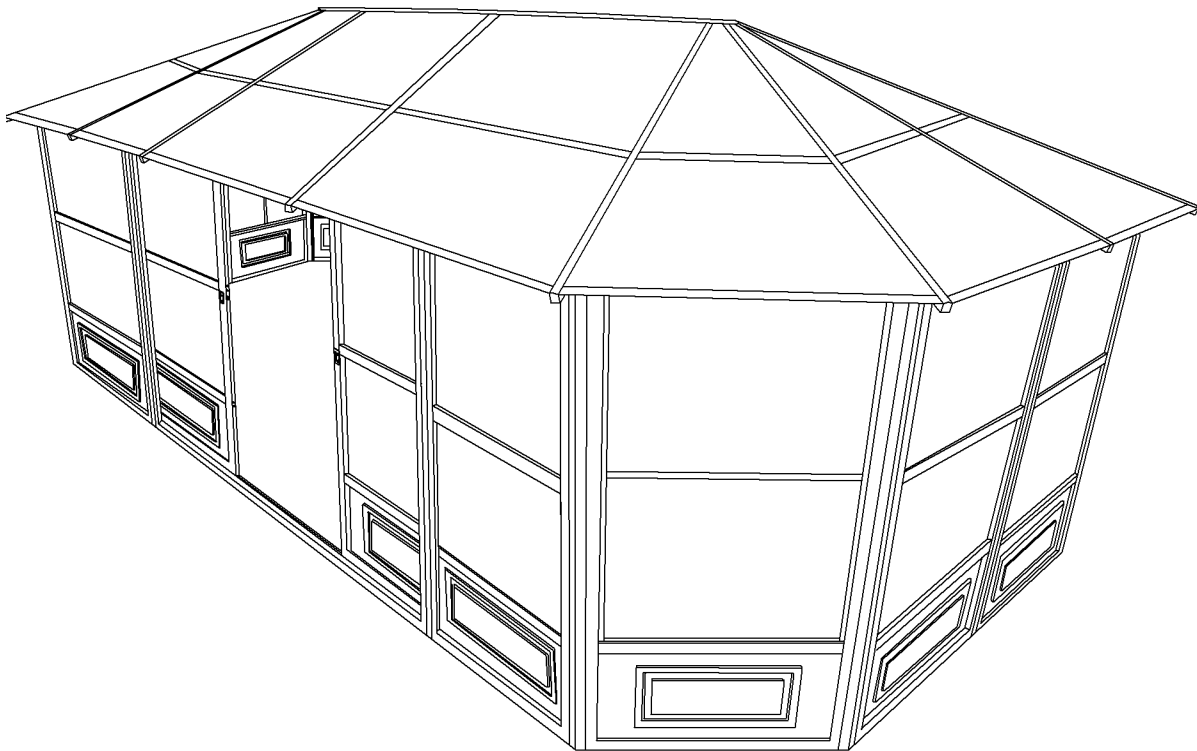

**DO NOT DESTROY THE BOXES UNTIL COMPLETELY ASSEMBLED  
PLEASE VERIFY THE CONTENT OF EACH BOX AGAINST THE LIST OF PARTS**

Three adults required for assembly

Base Dimensions 12' ½"x18'11"  
Largest Dimensions 13'6"x20'4 ½"  
Overall Height 110" (see pg.24)

APPROX.

**DO NOT DESTROY THE BOXES UNTIL COMPLETELY ASSEMBLED  
PLEASE VERIFY THE CONTENT OF EACH BOX AGAINST THE LIST OF PARTS**

**12ft x 18ft / 3.66m x 5.49m Solarium**

**Instruction Manual**

**IMPORTANT: RETAIN FOR FUTURE REFERENCE, READ CAREFULLY**

**Consult with your local governing authority / local municipal codes regarding installation of temporary structures before purchase or assembly. Some jurisdictions may require permits for, or otherwise regulate, installation and use.**

For assistance with assembly, installation, parts, or customer service, contact Gazebo Penguin Customer Service Department at the numbers listed below (English & French, Mon-Fri 8:00 AM to 4:00 PM EST):

**Montreal:** (514) 276-3485

**Elsewhere in Canada and the US:** 1-800-737-7174

**WARNING:**

- For outdoor use.
- Snow should be regularly cleared from the roof and not allowed to accumulate.
- Retain your **proof of purchase** for warranty purposes. Also keep the **original boxes** until the installation is complete and correct.
- The unit may take more than 4 hours and 3 people are required for this assembly.

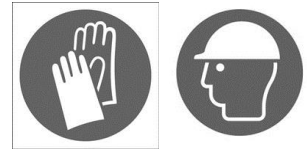

**PRIOR TO ASSEMBLY:**

- Please don't destroy boxes until completely assembled.
- The foundation must be level, flat, and solid, such as concrete or asphalt.
- Keep away from overhead utility lines, tree branches, and other structures.
- Check for underground pipes or wires if digging or drilling is required.
- Do not install near roof lines or other structures that could shed snow, ice, or excessive rain run-off onto the roof top.
- Assemble the structure as close to its final location as possible.
- It is recommended to wear safety gloves, safety glasses, and hard hats for installation.
- Do not hang from, climb on, or stand on the structure or roof.
- Before assembly, read instructions and check that all parts are present in the boxes. If any parts are missing, refer to warranty information.
- A 6ft (1.8m) stepladder, Phillips screwdriver, tape measure, level, mallet, and a tarp to place parts on will be required for assembly (not included).
- Remove top protective film from roof panels prior to assembly; **DO NOT** remove bottom protective film until ready to insert roof panels, so as to identify which side is on top.

**ANCHORING INSTRUCTIONS:**

- Proper anchoring of the frame to the base and the wall is required for safety.
- Any structure not anchored securely has the potential to fly away during high wind causing damage and safety hazard.
- How the item is anchored, and the hardware and tools required, will vary based upon the set up location and are not provided.
- Please check with your local hardware store if for the appropriate anchors for your surface.
- Do not anchor to pavers / pavement slabs because they are not a solid foundation.
- Periodically check the anchors to ensure they remain secure

**CARE AND MAINTENANCE:**

- In case of a defective or damaged part, or for any other questions concerning the product, please contact the manufacturer directly.
- Please have the parts list and part numbers on hand when ordering or requesting replacement parts.

**ROOF PANELS:**

- Gently clean with an environmentally-friendly soap solution and water using a sponge or washcloth.
- Do not use abrasive materials, wire brushes, chemicals, harsh cleaners, or bleach.
- Rinse using a garden hose and air dry. If removed, ensure thoroughly dry prior to storage.
- Do not use pressure washer.

**STRUCTURE:**

- Gently clean with an environmentally-friendly soap solution and water using a sponge or washcloth.
- Do not use abrasive materials, wire brushes, chemicals, harsh cleaners, or bleach.
- Rinse using a garden hose and air dry.
- Do not use pressure washer.
- If there are nicks, chips, and/or scratches see the part # of the paint in the parts list to obtain a matching touch-up paint.

## MAINTENANCE NOTES

1. In case of a defective or damaged part, or for any other questions concerning the product, please contact the manufacturer directly.
2. Please have the parts list and part numbers on hand when ordering or requesting replacement parts.
3. The product should not be installed adjacent to trees or a sloped roof. Snow and ice may slide onto the roof and cause it to collapse.
4. While the product is designed to stay assembled year long, the roof must be kept free of accumulation of snow.



## ONE YEAR LIMITED WARRANTY

This product has been designed and manufactured to meet the highest standards of quality and durability. Subject to the Conditions for Exercising the Warranty and the Limitations on the Warranty set forth below, it is warranted to be free of material and manufacturing defects for a period of **one year** from the date of purchase. Missing and damage due to transportation is not covered by the manufacture warranty. Should the product become damaged, or the warranty period has expired, please contact Gazebo Penguin Customer Service Department for a complete schedule of replacement parts and prices.

## CONDITIONS FOR EXERCISING THE WARRANTY

The warranty only applies to the original purchaser with the bill.

In order to properly exercise your warranty, please comply with the following:

Carefully inspect the contents of the carton for missing or damaged components. Should you discover damaged or missing parts, **do not return the product to the place of purchase**, but contact Gazebo Penguin Customer Service Department at the numbers listed below:

**Montreal:** (514) 276-3485

**Elsewhere:** 1-800-737-7174

You can also find a claim form to fill out online:

<https://abrispenguin.com/assemblyinstructions/>

**NOTE: Damages/missing parts must be reported within 30 days of delivery. If claimed after your request might be rejected.**

## LIMITATIONS ON THE WARRANTY

1. The product is not warranted against damages due to vandalism, abuse, falling or thrown objects, or accumulation of snow.
2. The product is not warranted against damages due to extreme weather conditions, such as thunderstorms, hail, strong wind or snow storms, or any other acts of God.
3. Leaking due to heavy rain may happen, please refer to the instruction manual for window positions and information on how to evacuate the water.
4. The product is only warranted in the event it is installed in accordance with the Gazebo Penguin's written instructions enclosed with the product.
5. The product is not warranted in the event it has been improperly anchored.
6. We reserve the right to replace or repair any defective product or parts at our discretion.
7. No change to the unit is allowed. This will void your warranty.

## Before you assemble the Solarium

**PLEASE DON'T DESTROY THE BOXES UNTIL COMPLETELY ASSEMBLED**

### Tools needed:

- Step Ladder 6'-8'
- #2 Phillips, #2 Robertson Screwdriver (not supplied)
- Rubber Mallet
- Various Files
- 12" piece of wood

Based on the location, decide where you would like to position the solarium. Remember the sliding door with "C" shape should be placed on the left side.

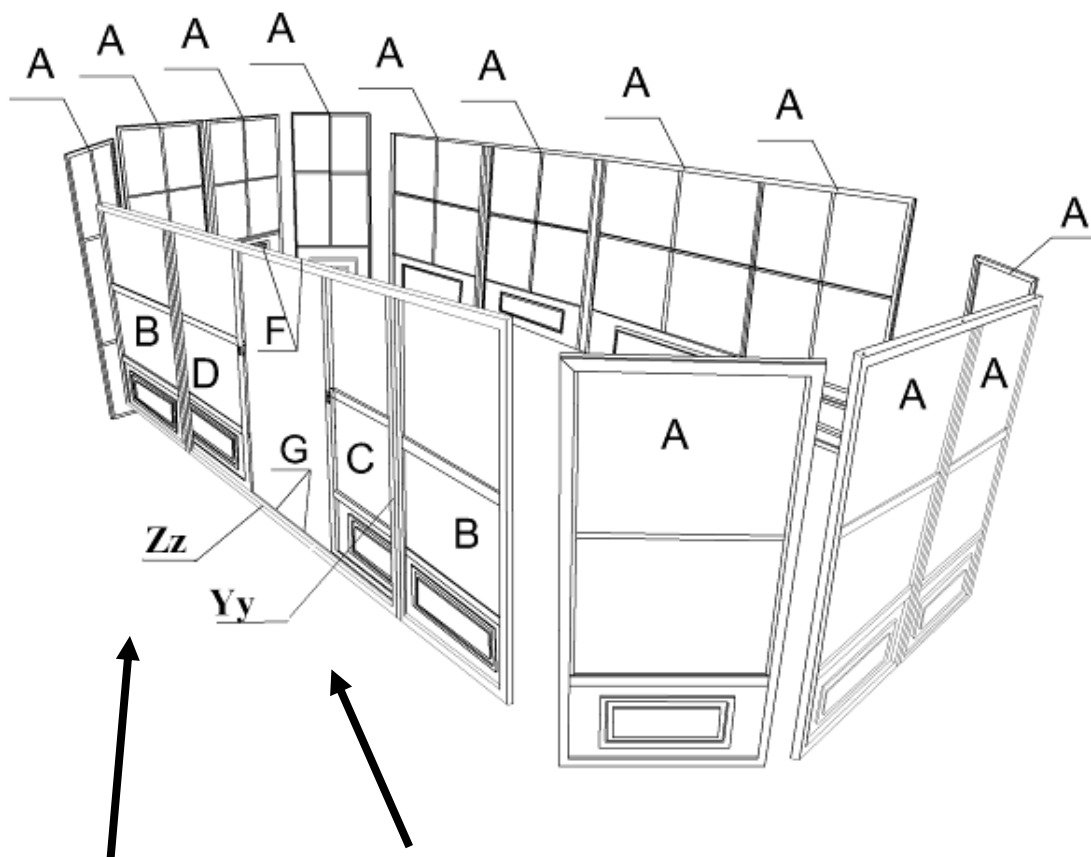

Sliding door with receiver channel

Regular sliding door

# 12x18 Solarium Assembly Instructions

## Step 1:

Before starting to assemble, please decide where you would like to position the door panels.

1. Stand up two regular frames (A), using two connecting pieces (E) and affix the panels (A) together
2. Assemble door frame separately. Assemble 2 vertical bars (Yy) with 2 horizontal bars (Zz). Make sure the shape of the aluminum matches the other parts to be joined. With a rubber mallet get them closed at the corners. Make sure to not damage the aluminum parts. Use screws (Z) to secure 4 corners manually, screwing all screws into frame 4 predrilled holes.
3. After assembling door frame, attach to frames (B) on either side, by sliding connecting piece (E) between the frame and the door frame.
4. When assembling angled panels (A, B), you should put the two panels at 135 degree angle then use the angled connecting pieces (I) and (J) to affix the panels together.

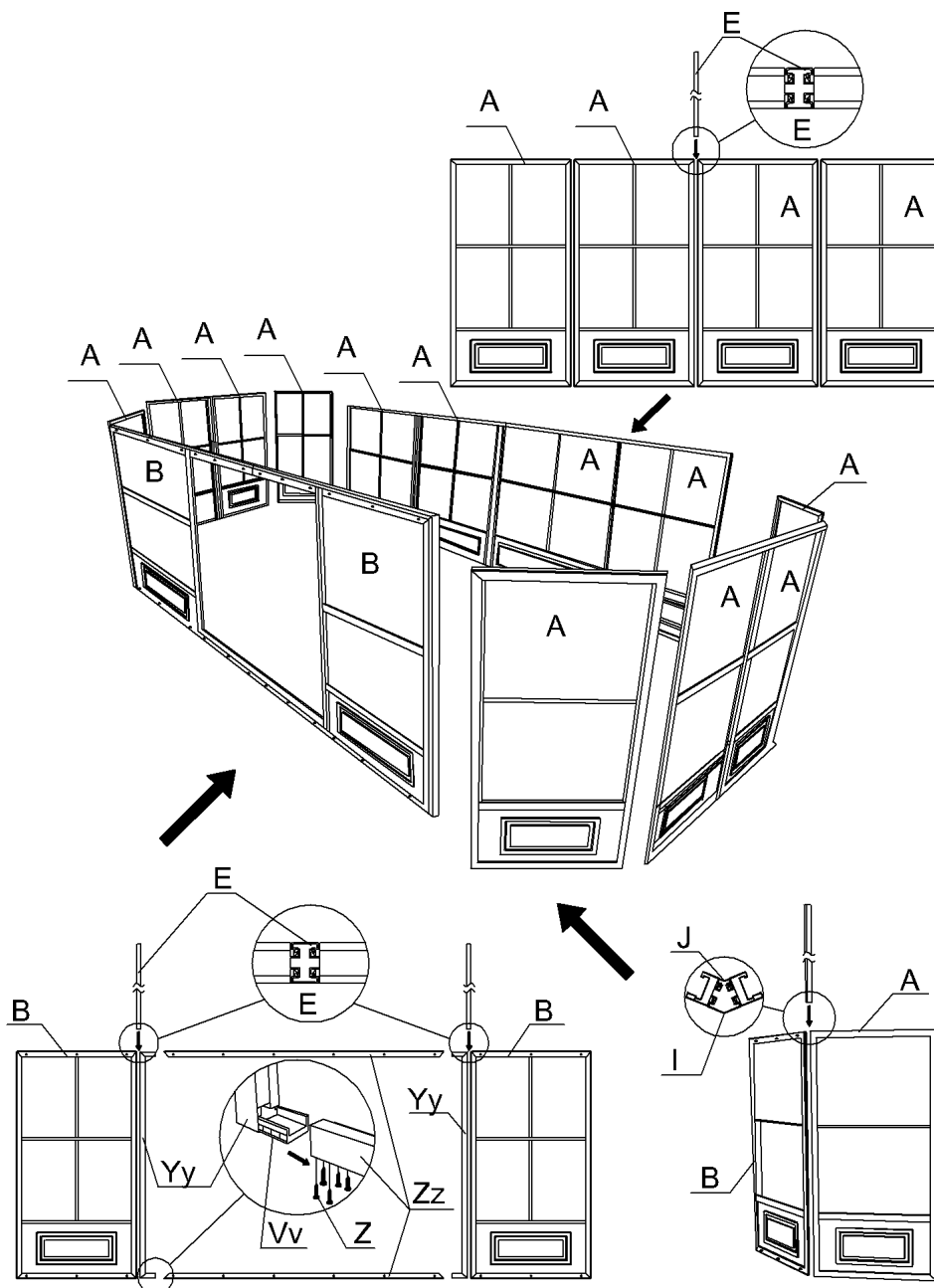

**Step 2:**

1. Place a bolt (Ww) and washer (Gg) through the top door rail (F) and door frame, and a female bolt (Cc-2) from the other side. Once all are inserted, tighten them all securely.
2. Secure bottom door rail (G), using a bolt (Cc) and washer (Gg).

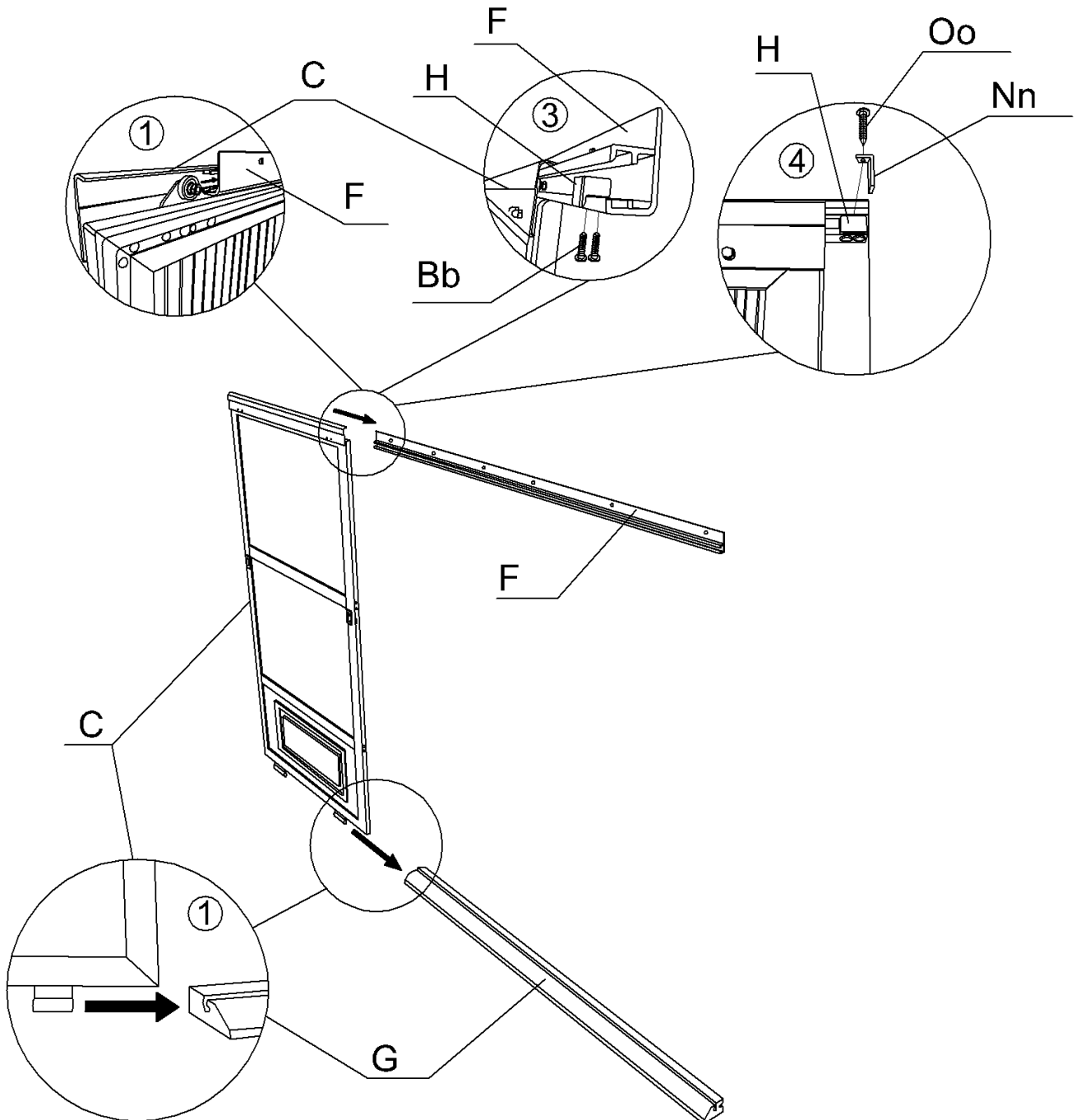

**Step 3:**

**Please note the sliding door should be installed from the inside of the solarium.**

1. Attach the door wheels into the top of door rail (F) of the sliding door (C).
2. Attach the plastic piece into the bottom door rail (G) of the sliding door(C).
3. Use bolt (Bb) to affix the plastic stoppers (H), one on each end of the top door rail (F).
4. Then use screw (Oo) to affix the upper door rail end caps (Nn) one at each end of top rail (F).
5. The other side of top rail (F) is same as above step.

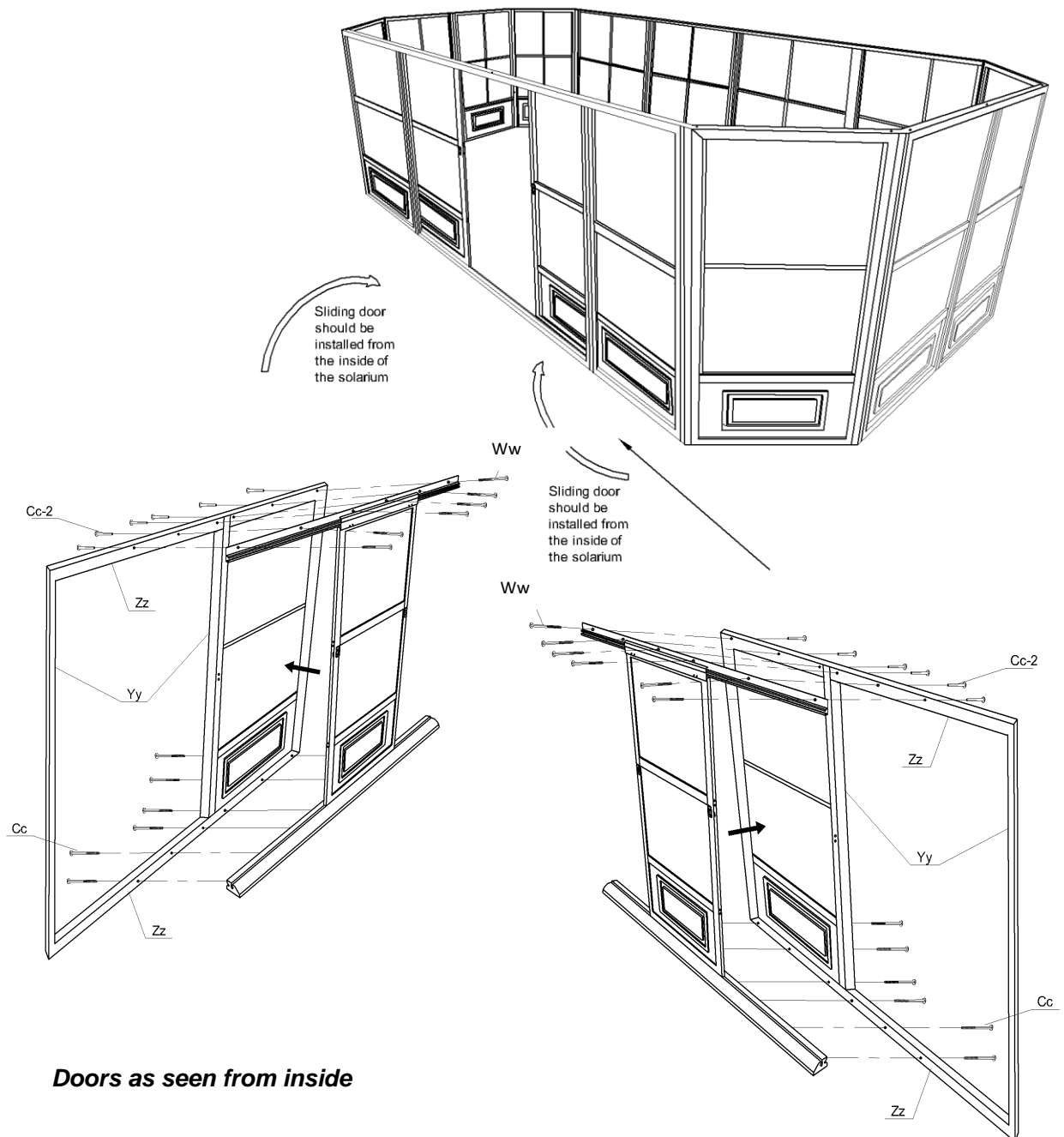

**Doors as seen from inside**

**Repeat steps 2 and 3 for the second door.**

**Step 4:**

1. Attach roof rafters (L) to the central hub (N) using bolt (Bb). (Caution: hub may be heavy, use support if needed)
2. Use screws (Bb) attached to brackets to affix the roof rafter (Xx) onto the top of the middle of the door panel.
3. Use screw (Z) to affix the other rafters (L) onto the top of panels going through the metal piece attached to the rafter (L).

**Note:** Rafters must be affixed where panels connect to each other.

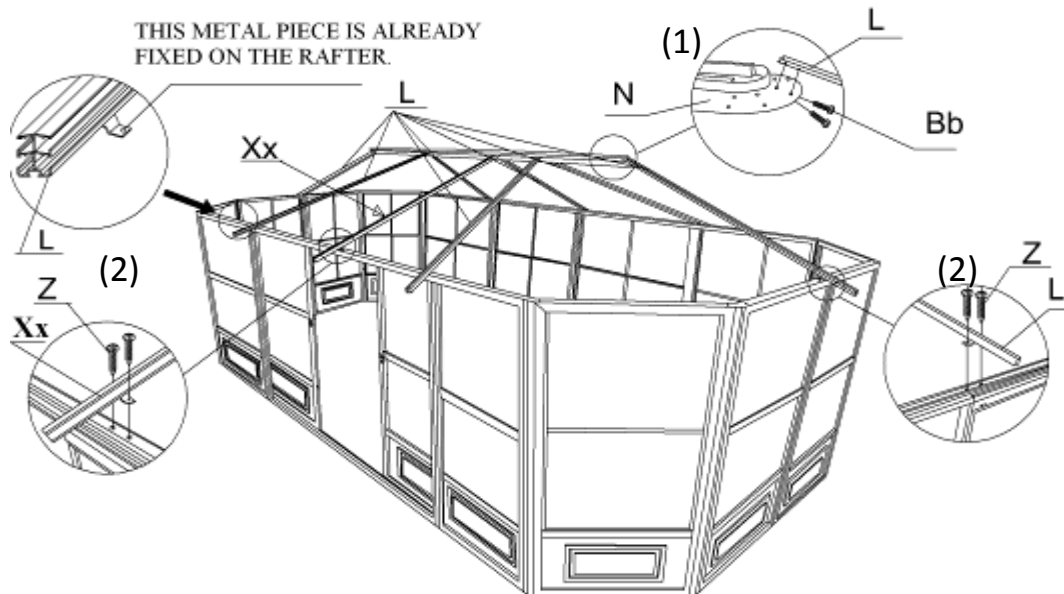

**Step 5:**

Use the same method to assemble roof rafters (K) for the angled panels. The metal piece affixed to the rafter (K) is adjustable, choose one hole to affix the rafter (K) to the top of the panel.

**Note:** 1) The K Rafter has 1 bracket with 2 holes. Attach roof with 1 screw when installing on top of the frames. Make sure that extra hole on bracket remains on the side of angled panel (at the corner).

2) Do not tighten the bolts right away as you may have to adjust the angle when inserting the PC roof panels.

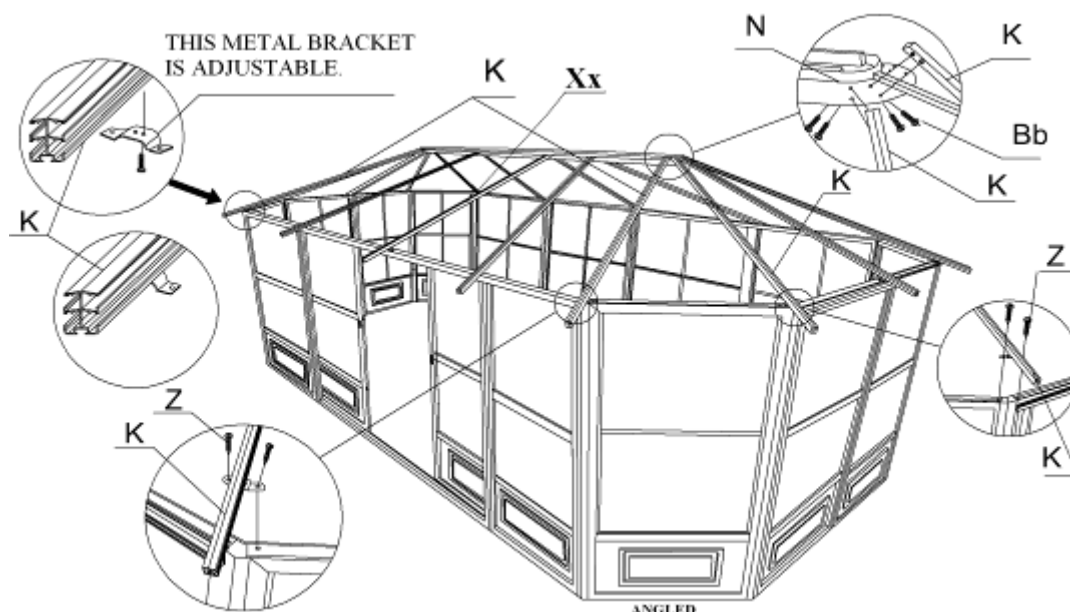



**Step 6:**

Use nut (Hh) and washer (Gg) to affix the top cap (M) to the central hub (N).

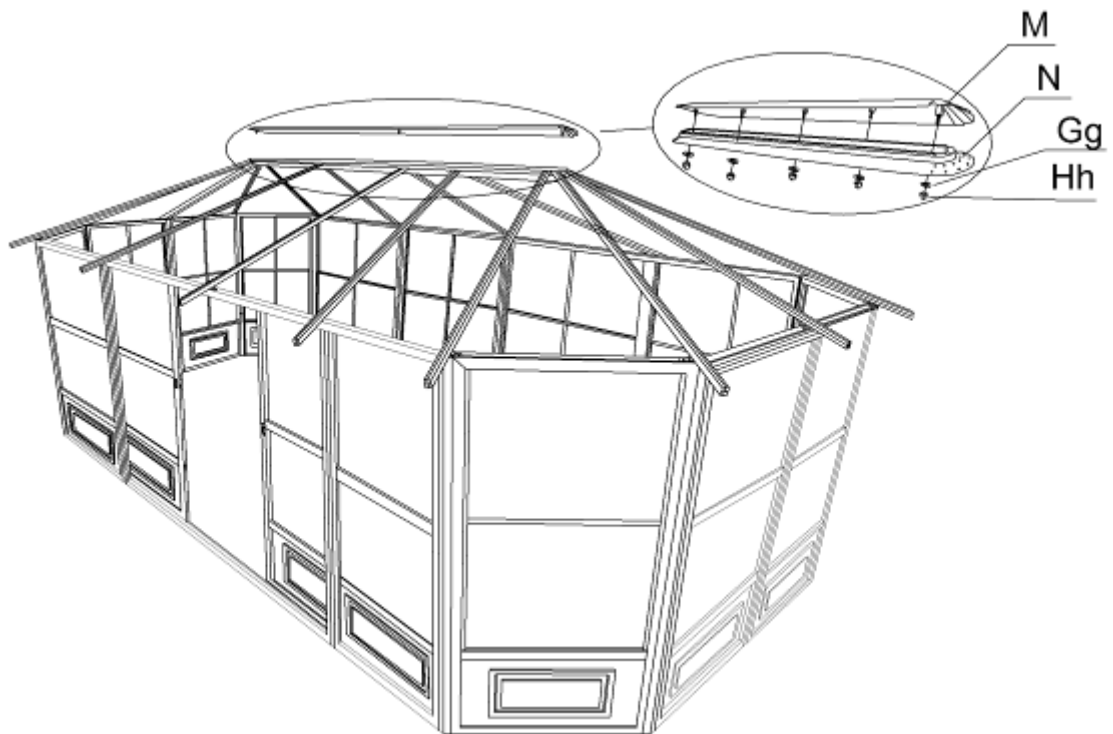

**Step 7:**

First remove the protective layer from the PC panels, then insert them (Y, Aa, Ll, Qq) between the roof rafters according to the below drawing instructions.

**Note:** the side that had the protective layer should be face down.

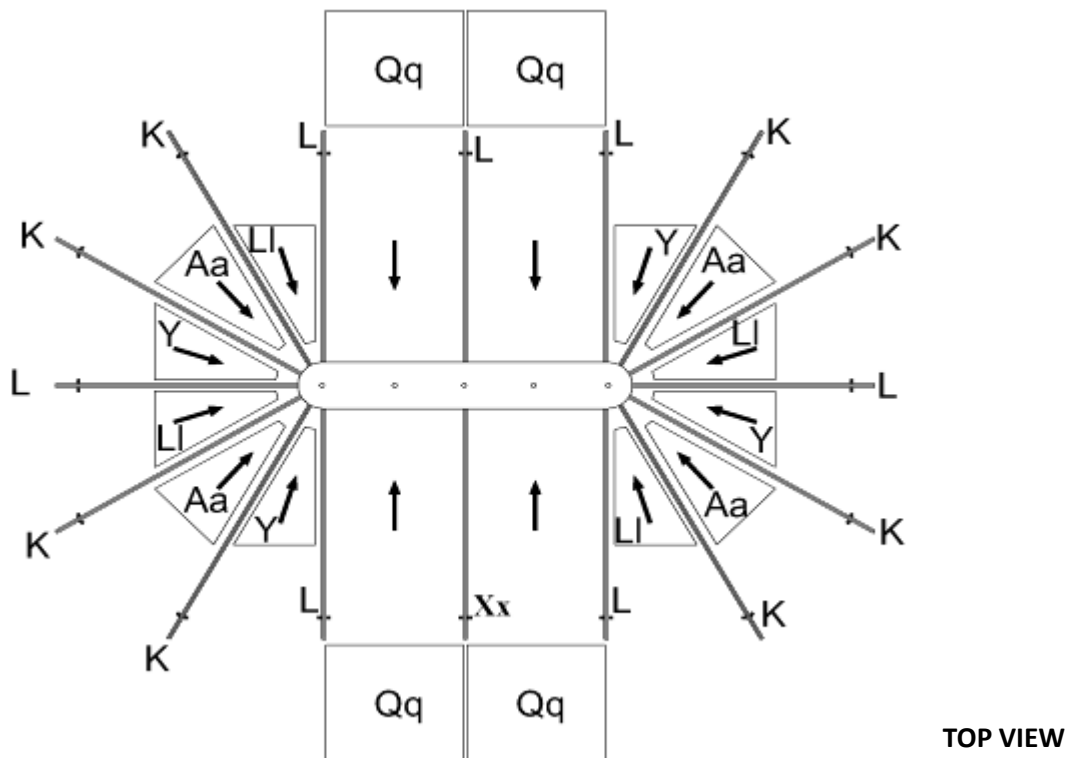

**Step 8:**

After inserting the upper PC panels, insert the aluminum middle roof joints (O, P, Q, Pp) into the roof rafters. The below drawing view is from inside the solarium looking up.

**Notes:**

- The drain holes on the aluminum middle roof joints (O, P, Q, Pp) should be at the bottom.
- To adjust the middle joints to line up : once all polycarbonate roof panels are in place, use a small piece of wood and hammer, then tap down on the middle of the joint bringing it down and holding at the same time the joint and top polycarbonate. Do not tap too hard.

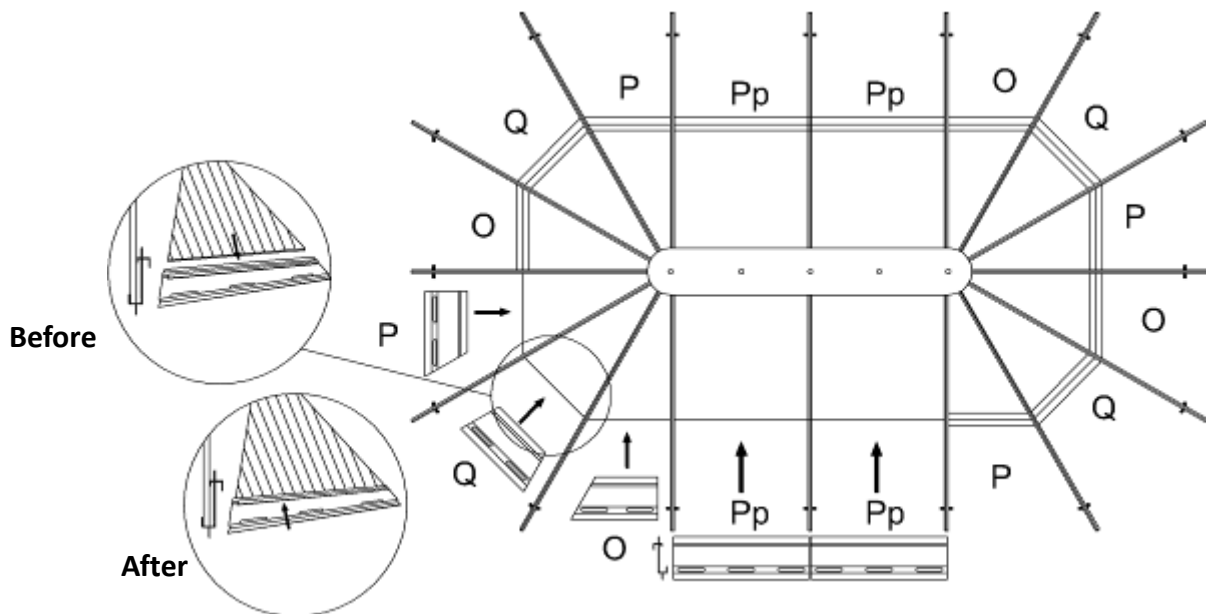

**Step 9:**

After the installation of the middle roof joints complete, insert the bottom PC roof panels (Jj, Kk, Mm, Rr) according to below drawing instructions. They should overlap about two inches under the upper PC roof panels and into the aluminum middle joints.

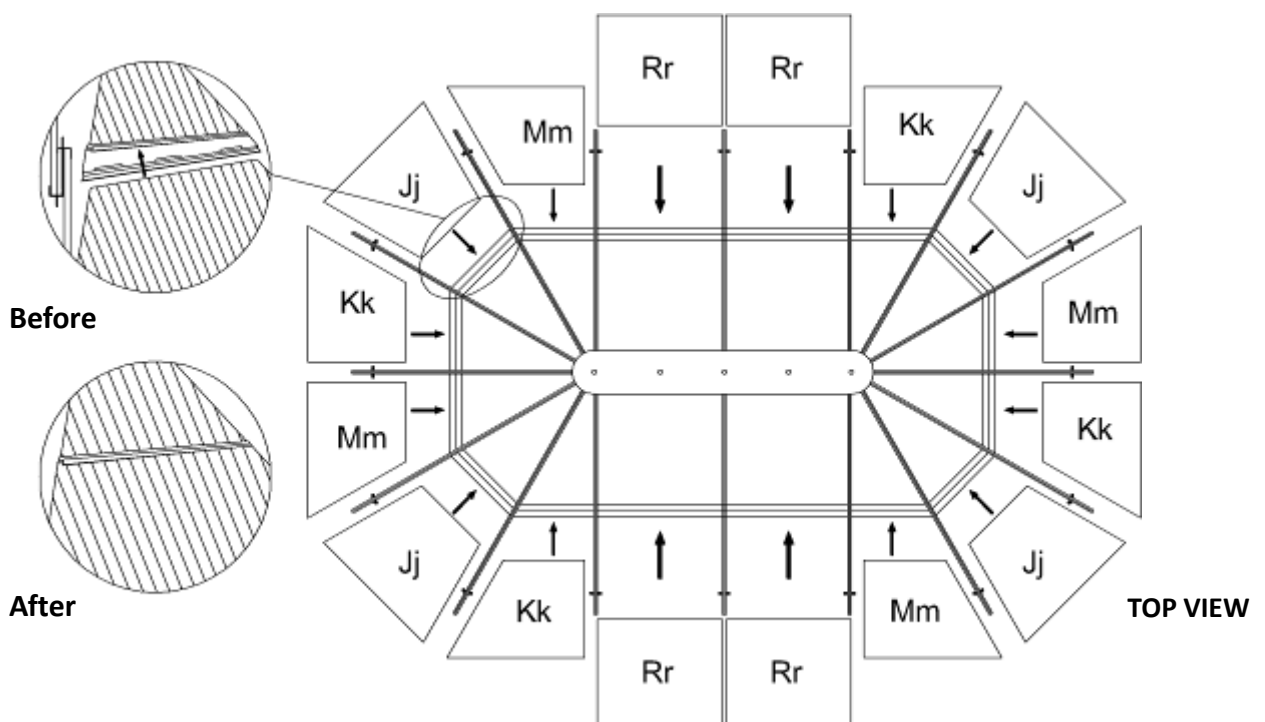

**Step 10:**

Once the PC roof is complete, use aluminum edging (S, U, W, Ss) to surround the edges of the PC roof, using bolt (Bb) and rafter cap (R), tighten securely.

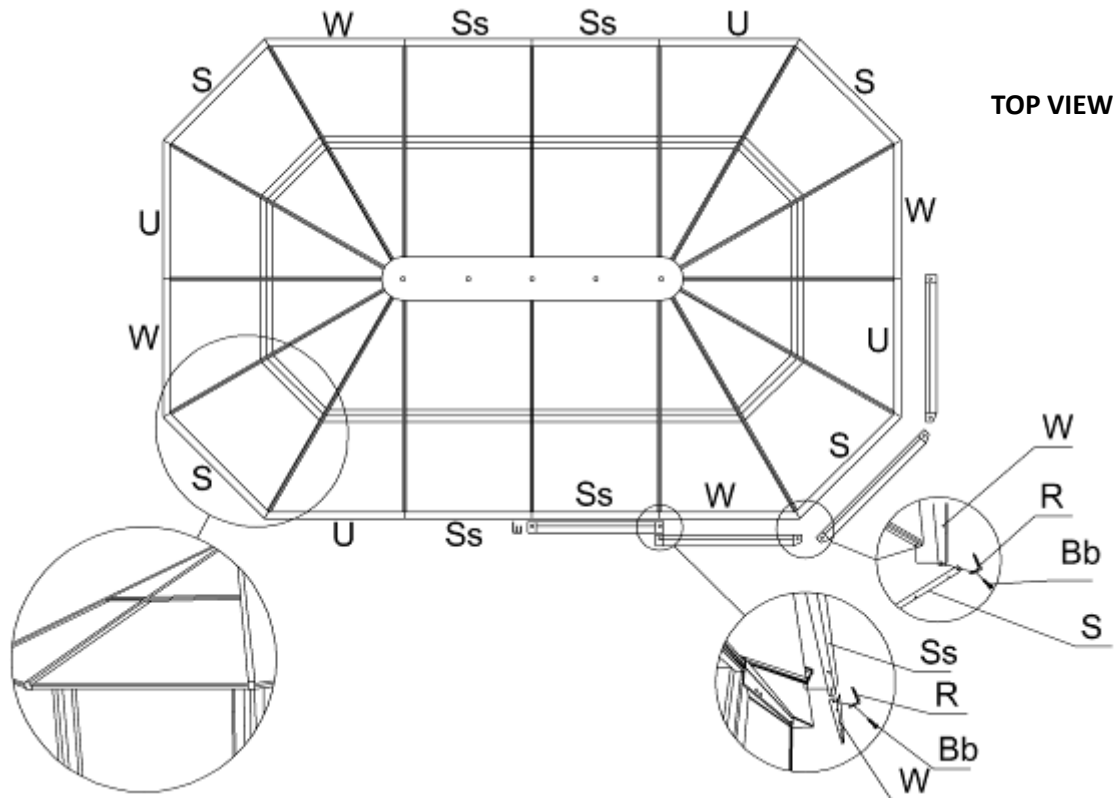

**Step11:**

Once the installation of the edging complete, start affixing the roof cross bars (T, V, X, Tt) using bolt (Ff). Affix the top cross bars (Uu) onto the roof rafter (L) using bolt (Ff).

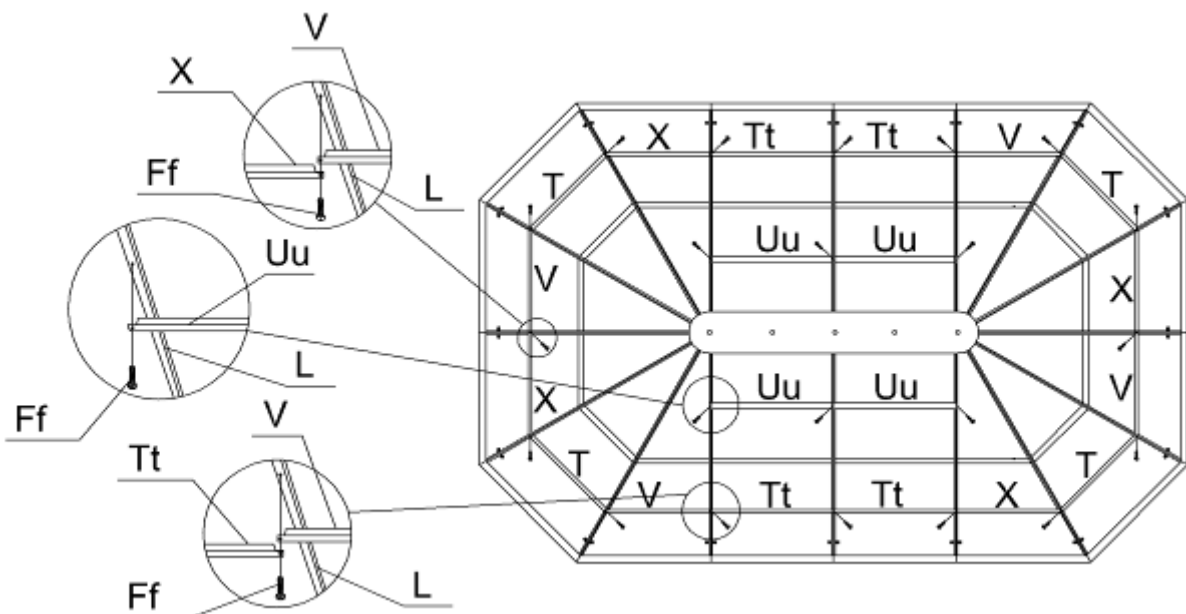

**Step 12:**

Inside each of the panels (A, B), push two plastic plugs (li) into the ground, and then screw down the panels using two screws (Ee) for each panels.

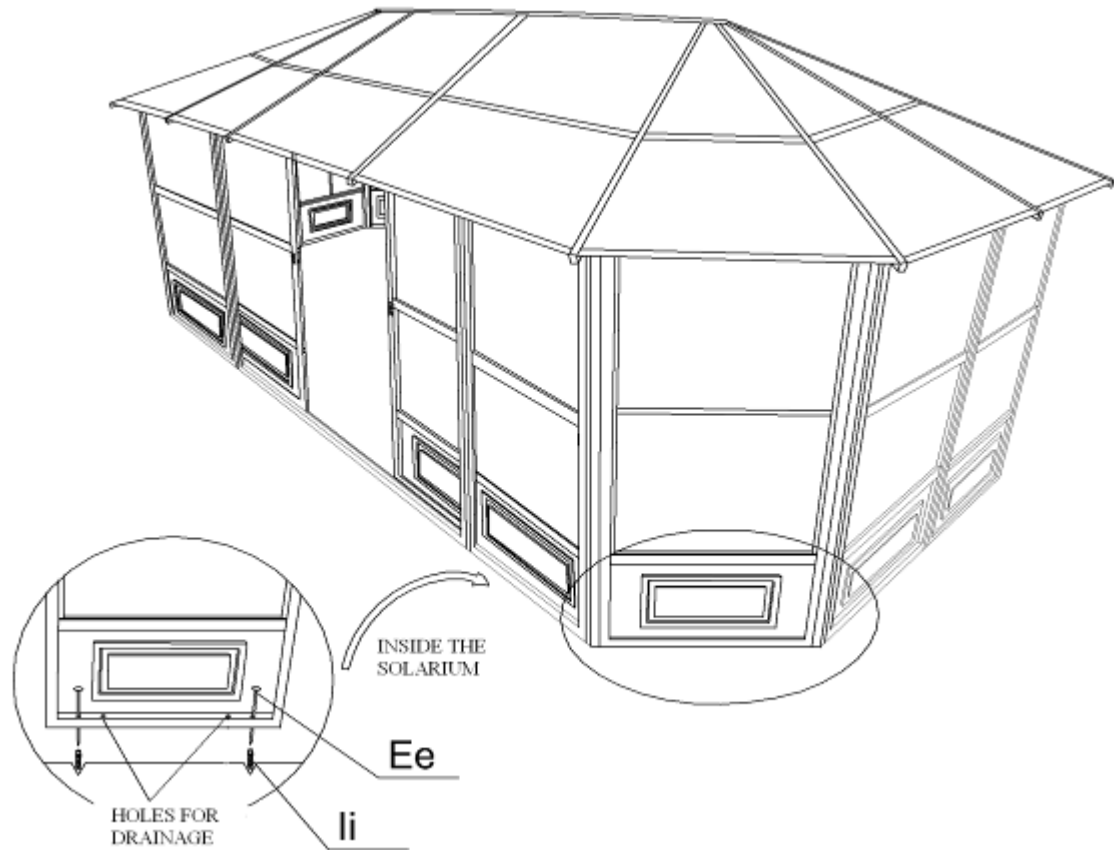

**Special notes:**

1. To remove windows (08-219), pull 1 pin out of the lock position and push the frame to the end of the track, then ease the window out of the tracks one side at a time.
2. To remove screening panel, first remove windows, then unscrew the 2 screws at the top corners of the screen frame.
3. Note that this unit is not waterproof. For best protection against rain, close the windows of each frame with the outside window in the center, and the inside window at the top.

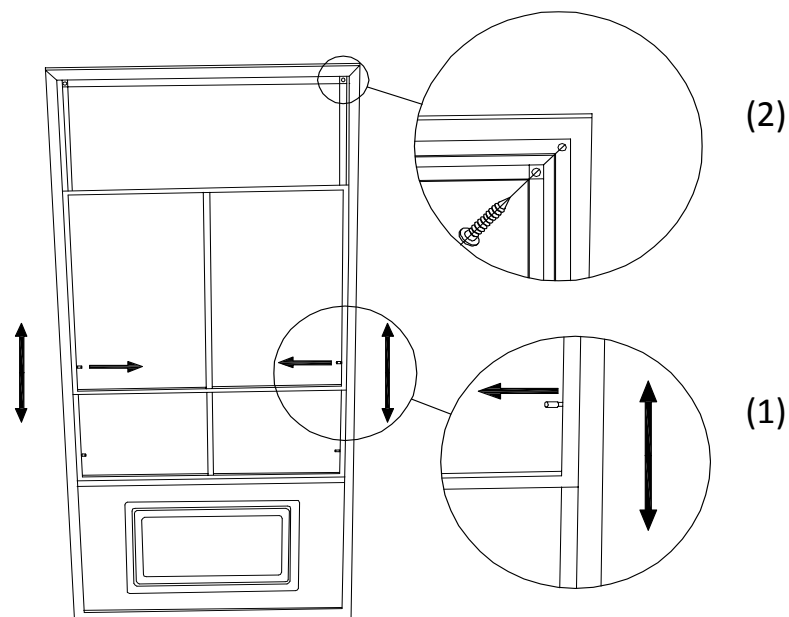

## **\*Suggestions**

The below mentioned are only suggestions in order to permit drainage, these will vary depending on your flooring – material, flatness and slope.

### **FOR CONCRETE FLOORING**

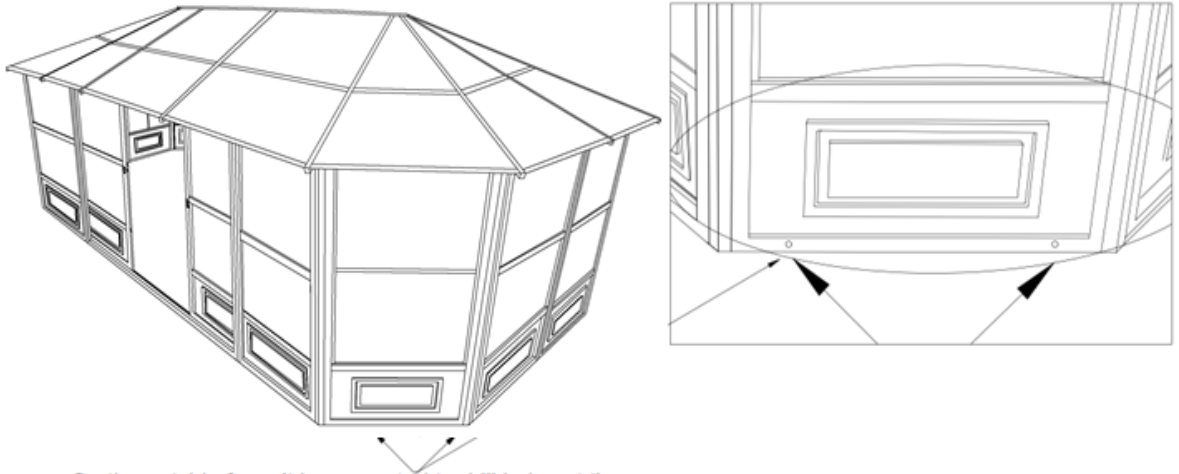





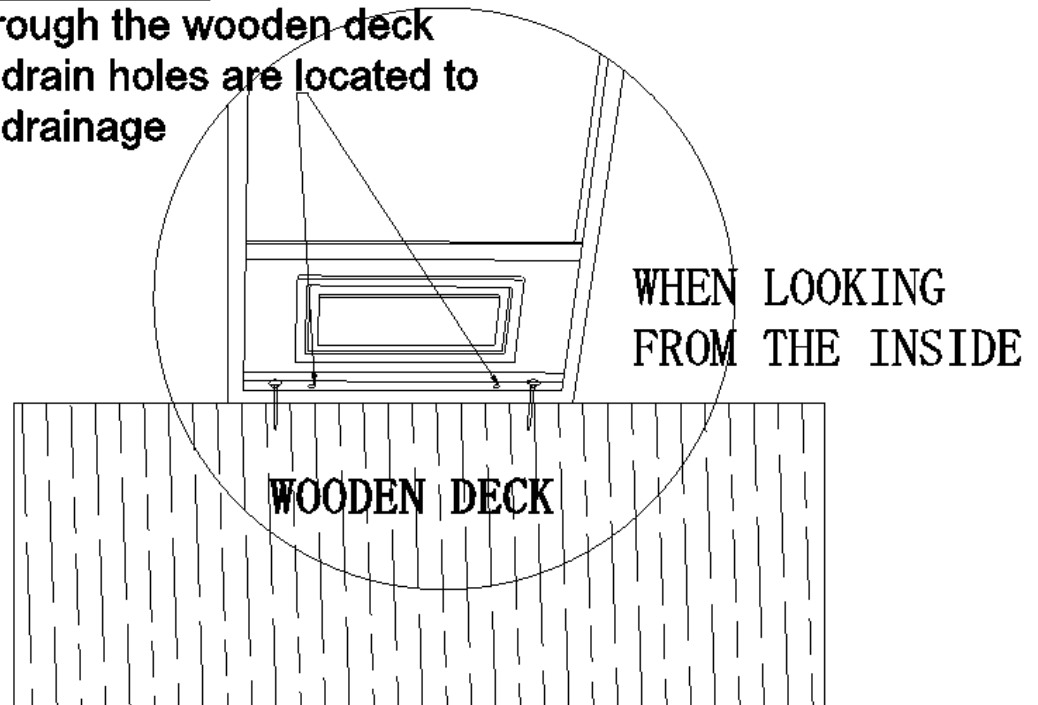

On the outside face, it is suggested to drill holes at the bottom end of the panels to permit drainage when installing on Concrete floor



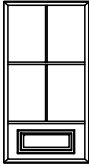
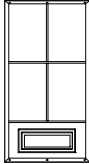
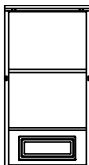
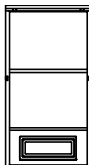

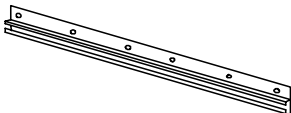
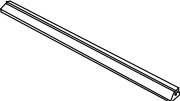
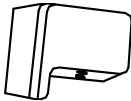
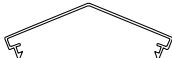
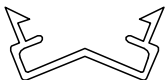
### **For Wooden Deck**





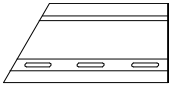
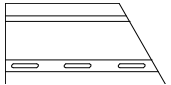
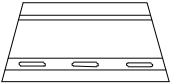

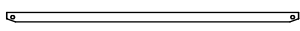
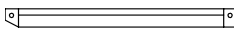
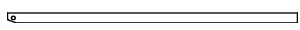
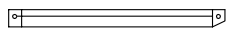
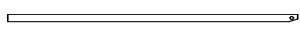
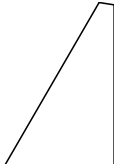
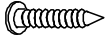
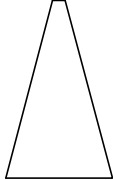
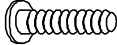
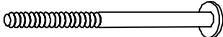
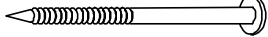
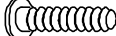



**Drill through the wooden deck where drain holes are located to permit drainage**

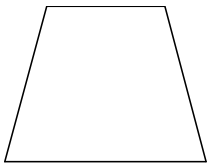
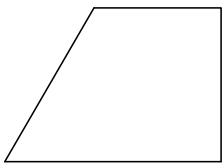
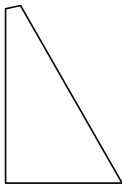
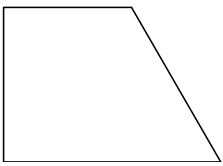

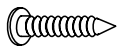
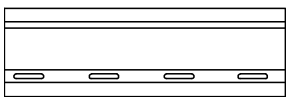

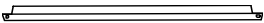
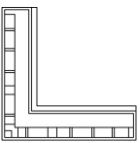

## 12X18 Solarium Sand (see page 19 for Slate parts)



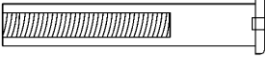

DESCRIPTION	PACKED IN BOX	QTY	DRAWING	DESCRIPTION	PACKED IN BOX	QTY	DRAWING
08-129-12 REGULAR FRAME A	2	4		08-130-12 FRAME NEXT TO DOOR B	2	2	
	3	8					
08-159-12 REGULAR SLIDING DOOR C	2	1		08-160-12 SLIDING DOOR WITH RECEIVER CHANNEL D	2	1	
08-133-12 CONNECTING PIECE E Length 200.6 cm	4	14		08-162-12 TOP DOOR RAIL F Length 208 cm	4	2	
08-163-12 BOTTOM DOOR RAIL G Length 205.6 cm	4	2		08-138-12 PLASTIC STOPPER H	5	4	
08-139-12 135° ANGLED OUTSIDE CONNECTOR I Length 200.6 cm	4	8		08-140-12 135° ANGLED INSIDE CONNECTOR J Length 200.6 cm	4	8	
08-141-12 ROOF RAFTER K Length 239.7 cm	4	8		08-142-12 ROOF RAFTER L Length 211 cm	4	7	
08-164-12 TOP CAP M	4	1		08-166-12 CENTRAL HUB N	4	1	

DESCRIPTION	PACKED IN BOX	QTY	DRAWING	DESCRIPTION	PACKED IN BOX	QTY	DRAWING
08-145-12 MIDDLE ROOF JOINT O	5	4		08-146-12 MIDDLE ROOF JOINT P	5	4	
08-147-12 MIDDLE ROOF JOINT Q	5	4		08-148-12 ROOF RAFTER CAP R	5	16	
08-149-12 EDGING S Length 120.6 cm	5	4		08-150-12 ROOF CROSS BAR T Length 94.5 cm	5	4	
08-151-12 EDGING U Length 120.6 cm	5	4		08-152-12 ROOF CROSS BAR V Length 94.4 cm	5	4	
08-153-12 EDGING W Length 120.6 cm	5	4		08-154-12 ROOF CROSS BAR X Length 94.4 cm	5	4	
08-155 (24 1/4"x42 1/4") TOP ROOF LEFT PANEL Y	1	4		08-156-12 SCREW Z	5	64	 (M4*16mm)
08-157 (24 1/2"x46 1/2") TOP ROOF CORNER PANEL Aa	1	4		08-158-12 BOLT Bb	5	76	 (M6*16mm)
08-161-12 BOLT Cc	5	12	 (M6*70mm)	08-167-12 SCREW Ee	5	28	 (M6x63.5mm)
08-168-12 BOLT Ff	5	24	 (M6*12mm)	08-187 WASHER Gg	5	45	



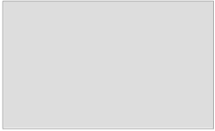

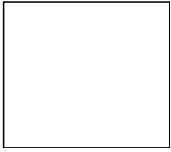
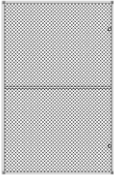
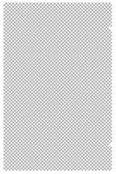

DESCRIPTION	PACKED IN BOX	QTY	DRAWING	DESCRIPTION	PACKED IN BOX	QTY	DRAWING
08-189-12 ACORN NUT Hh	5	5		08-193 PLASTIC PLUG li	5	28	
08-195 (47"x47 1/2") BOTTOM ROOF CORNER PANEL Jj	1	4		08-196 (46 1/4"x43") BOTTOM ROOF LEFT PANEL Kk	1	4	
08-197 (24 1/4"x42 1/2") TOP RIGHT ROOF PANEL Ll	1	4		08-198 (46 1/4"x43") BOTTOM ROOF RIGHT PANEL Mm	1	4	
08-134-12 UPPER DOOR RAIL END CAP Nn	5	2		08-135-12 SCREW Oo	5	4	 (M4*12mm)
08-170-12 MIDDLE ROOF JOINT Pp	5	4		08-172 (41 1/4"x42 1/4") TOP ROOF CENTER PANEL Qq	1	4	
08-171 (41 1/4"x43") BOTTOM ROOF CENTER PANEL Rr	1	4		08-173-12 EDGING Ss Length 108 cm	5	4	
08-174-12 ROOF CROSS BAR Tt Length 108 cm	5	4		08-175-12 TOP ROOF CROSS BAR Uu Length 108 cm	5	4	
11-599 CORNER KEY Vv (INSTALLED IN Yy)	2	4		08-192-12 ROOF RAFTER ON THE MIDDLE OF THE DOOR Xx Length 211 cm	4	1	



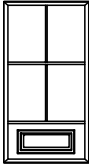
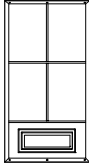
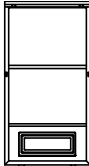
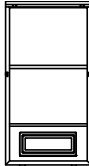

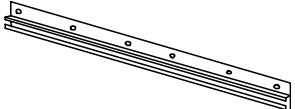
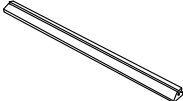
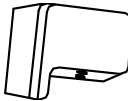
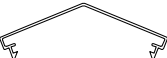
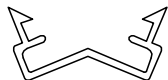





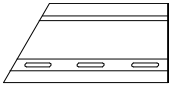
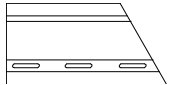
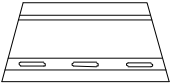

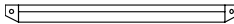
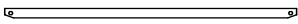

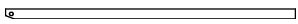
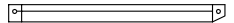

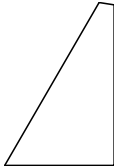
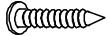
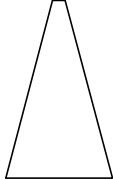
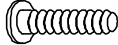
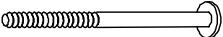
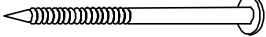
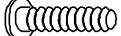



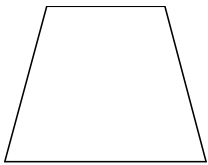
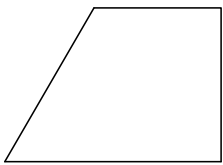
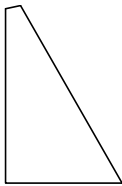
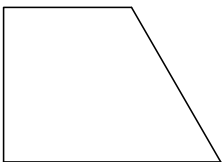

DESCRIPTION	PACKED IN BOX	QTY	DRAWING	DESCRIPTION	PACKED IN BOX	QTY	DRAWING
11-597-12 VERTICAL DOOR FRAME Yy Length 200 cm	2	2		11-598-12 HORIZONTAL BAR FOR DOOR FRAME Zz Length 206.14 cm	2	2	
12-037-12 FEMALE BOLT Cc-2	5	12	 M5*60mm	12-047-12 BOLT Ww	5	12	 <b>(M5*15mm)</b>
11-623 EXTRA SINGLE DOOR			AVAILABLE PLEASE CALL				

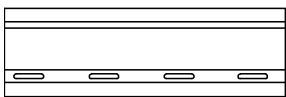



AVAILABLE REPLACEMENT PARTS			
DESCRIPTION	DRAWING		DESCRIPTION
08-219-12 PVC WINDOW (in frame)			11-572-12 BOTTOM PLASTIC PANEL (for wall panels)
10-493 PVC WINDOW (replacement material only)			11-823-12 BOTTOM PLASTIC PANEL (for double doors)
85-417-P ROUND SPLINE FOR PVC WINDOW			15-097-12 DOOR WHEEL ASSEMBLY
15-123-12 PIN FOR PVC WINDOW			11-736-12 RECEIVER CHANNEL FOR DOUBLE DOOR
13-054 PC WINDOW (for double door)			10-458 REPLACEMENT WEATHERSTRIP
12-046-12 MOSQUITO SCREEN (in frame)			15-124-12 MOUNTING BRACKET FOR RAFTER (K)
85-014 REPLACEMENT SCREENING (no frame)			15-125-12 MOUNTING BRACKET FOR RAFTER (L)
85-417-S ROUND SPLINE FOR SCREENING			19-102-12 MOUNTING BRACKET FOR RAFTER (Xx)
DESCRIPTION	COLOUR	PART #	
SPRAY PAINT	SAND	11-699	
PAINT PEN		18-245	

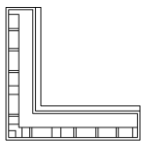

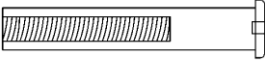

## 12X18 Solarium Slate

DESCRIPTION	PACKED IN BOX	QTY	DRAWING	DESCRIPTION	PACKED IN BOX	QTY	DRAWING
08-129-32 REGULAR FRAME A	2	4		08-130-32 FRAME NEXT TO DOOR B	2	2	
	3	8					
08-159-32 REGULAR SLIDING DOOR C	2	1		08-160-32 SLIDING DOOR WITH RECEIVER CHANEL D	2	1	
08-133-32 CONNECTING PIECE E Length 200.6 cm	4	14		08-162-32 TOP DOOR RAIL F Length 208 cm	4	2	
08-163-32 BOTTOM DOOR RAIL G Length 205.6 cm	4	2		08-138-32 PLASTIC STOPPER H	5	4	
08-139-32 135° ANGLED OUTSIDE CONNECTOR I Length 200.6 cm	4	8		08-140-32 135° ANGLED INSIDE CONNECTOR J Length 200.6 cm	4	8	
08-141-32 ROOF RAFTER K Length 239.7 cm	4	8		08-142-32 ROOF RAFTER L Length 211 cm	4	7	
08-164-32 TOP CAP M	4	1		08-166-32 CENTRAL HUB N	4	1	

DESCRIPTION	PACKED IN BOX	QTY	DRAWING	DESCRIPTION	PACKED IN BOX	QTY	DRAWING
08-145-32 MIDDLE ROOF JOINT O	5	4		08-146-32 MIDDLE ROOF JOINT P	5	4	
08-147-32 MIDDLE ROOF JOINT Q	5	4		08-148-32 ROOF RAFTER CAP R	5	16	
08-149-32 EDGING S Length 120.6 cm	5	4		08-150-32 ROOF CROSS BAR T Length 94.5 cm	5	4	
08-151-32 EDGING U Length 120.6 cm	5	4		08-152-32 ROOF CROSS BAR V Length 94.4 cm	5	4	
08-153-32 EDGING W Length 120.6 cm	5	4		08-154-32 ROOF CROSS BAR X Length 94.4 cm	5	4	
08-155 (24 1/4"x42 1/4") TOP ROOF LEFT PANEL Y	1	4		08-156-32 SCREW Z	5	64	 (M4*16mm)
08-157 (24 1/2"x46 1/2") TOP ROOF CORNER PANEL Aa	1	4		08-158-32 BOLT Bb	5	76	 (M6*16mm)
08-161-32 BOLT Cc	5	12	 (M6*70mm)	08-167-32 SCREW Ee	5	28	 (M6x63.5mm)
08-168-32 BOLT Ff	5	24	 (M6*12mm)	08-187 WASHER Gg	5	45	

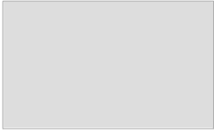
DESCRIPTION	PACKED IN BOX	QTY	DRAWING	DESCRIPTION	PACKED IN BOX	QTY	DRAWING
08-189-32 ACORN NUT Hh	5	5		08-193 PLASTIC PLUG Ii	5	28	
08-195 (47"x47 1/2") BOTTOM ROOF CORNER PANEL Jj	1	4		08-196 (46 1/4"x43") BOTTOM ROOF LEFT PANEL Kk	1	4	
08-197 (24 1/4"x42 1/2") TOP RIGHT ROOF PANEL Ll	1	4		08-198 (46 1/4"x43") BOTTOM ROOF RIGHT PANEL Mm	1	4	
08-134-32 UPPER DOOR RAIL END CAP Nn	5	2		08-135-32 SCREW Oo (M4*12mm)	5	4	
08-170-32 MIDDLE ROOF JOINT Pp	5	4		08-172 (41 1/4"x42 1/4") TOP ROOF CENTER PANEL Qq	1	4	
08-171 (41 1/4"x43") BOTTOM ROOF CENTER PANEL Rr	1	4		08-173-32 EDGING Ss Length 108 cm	5	4	
08-174-32 ROOF CROSS BAR Tt Length 108 cm	5	4		08-175-32 TOP ROOF CROSS BAR Uu Length 108 cm	5	4	
11-599 CORNER KEY Vv (INSTALLED IN Yy)	2	4		08-192-32 ROOF RAFTER ON THE MIDDLE OF THE DOOR Xx Length 211 cm	4	1	

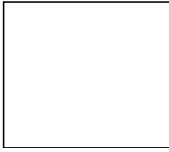
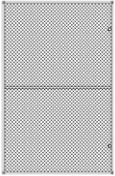
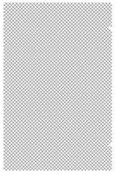
DESCRIPTION	PACKED IN BOX	QTY	DRAWING	DESCRIPTION	PACKED IN BOX	QTY	DRAWING
11-597-32 VERTICAL DOOR FRAME Yy Length 200 cm	2	2		11-598-32 HORIZONTAL BAR FOR DOOR FRAME Zz Length 206.14 cm	2	2	
12-037-32 FEMALE BOLT Cc-2	5	12	 M5*60mm	12-047-32 BOLT Ww	5	12	 <b>(M5*15mm)</b>
11-623 EXTRA SINGLE DOOR			AVAILABLE PLEASE CALL				

AVAILABLE REPLACEMENT PARTS			
DESCRIPTION	DRAWING		DESCRIPTION
08-219-32 PVC WINDOW (in frame)			11-572-32 BOTTOM PLASTIC PANEL (for wall panels)
10-493 PVC WINDOW (replacement material only)			11-823-32 BOTTOM PLASTIC PANEL (for double doors)
85-417-P ROUND SPLINE FOR PVC WINDOW			15-097-32 DOOR WHEEL ASSEMBLY
15-123-32 PIN FOR PVC WINDOW			11-736-32 RECEIVER CHANNEL FOR DOUBLE DOOR
13-054 PC WINDOW (for double door)			10-458 REPLACEMENT WEATHERSTRIP
12-046-32 MOSQUITO SCREEN (in frame)			15-124-32 MOUNTING BRACKET FOR RAFTER (K)
85-014 REPLACEMENT SCREENING (no frame)			15-125-32 MOUNTING BRACKET FOR RAFTER (L)
85-417-S ROUND SPLINE FOR SCREENING			19-102-32 MOUNTING BRACKET FOR RAFTER (Xx)
<b>DESCRIPTION</b>	<b>COLOUR</b>	<b>PART #</b>	
SPRAY PAINT	SLATE	18-125	
PAINT PEN		18-126	

**Note: The dimensions are approximate.**

