



Assembly Instructions

Caution : You must read this before you proceed

Reclining Chair



Parts List

Label	Picture	Description	QTY
A		Chair Backrest	1
B		Left Wing (Labelled B)	1
C		Right Wing (Labelled C)	1

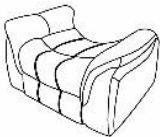
D		Chair Base with Footrest	1
---	---	--------------------------	---

Assembly Preparation

Before Beginning Assembly:

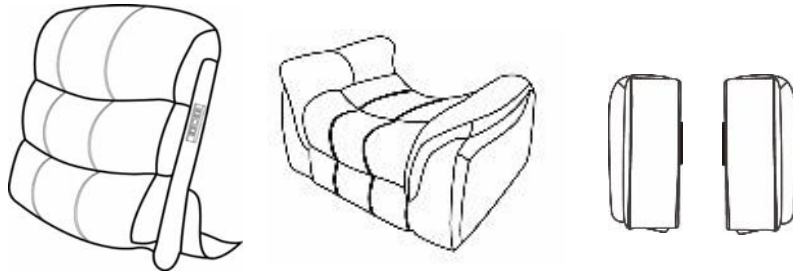

- Read instructions, cover to cover-



- Have 2 adults on hand for assembly-



- Do not assemble on flooring or carpet-



- Assemble on a clean non-marring surface (packing foam)-



- Save all packaging until finished-

Assembly Steps

Parts Introduction

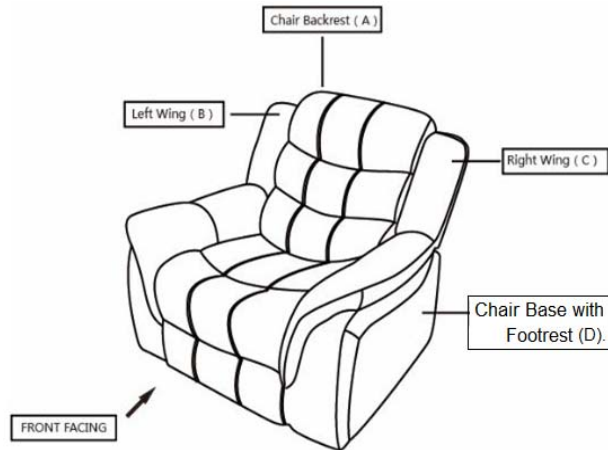

This Reclining Chair has multiple parts and may require up to some 30 minutes to assemble. To give you an overview of the Reclining Chair parts, the above picture is to help you put the various parts into perspective. Please read through the instructions below to familiarise yourself with the parts and steps before assembly.

Step 1

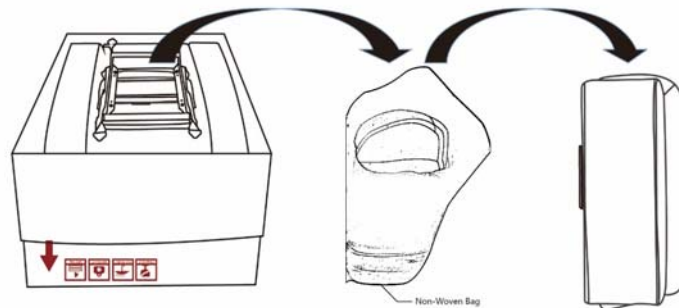

Take out 1 non-woven bag with one Wing inside from the bottom of the mechanism. Then take out the Wing from non-woven bag.

Step 2

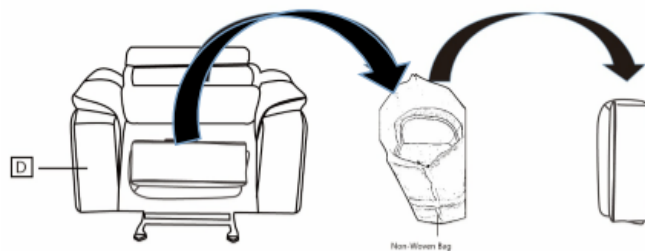

Take out 1 non-woven bag with one Wing inside from the back of Chair Base with Footrest (D). Then take out the Wing from non-woven bag.

Step 3

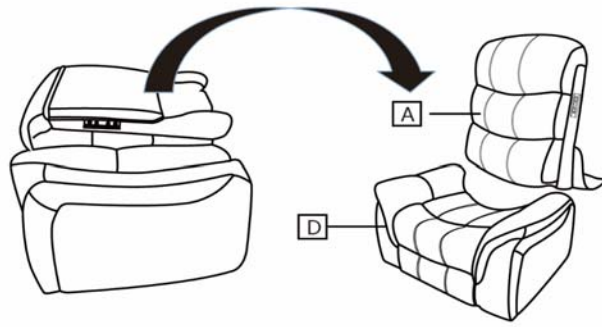

Take out the Chair Backrest(A) from the Chair Base with Footrest (D).

Step 4

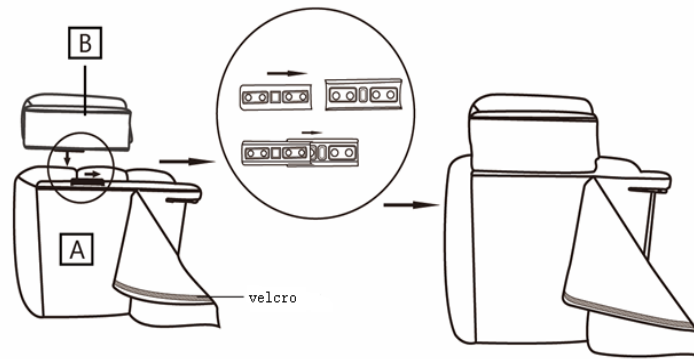

Position the Chair Backrest(A) on it's right side.
Align the mounting brackets of the Left Wing(B) with those on the left side of Chair Backrest(A).
Then slide Left Wing(B) forward by hand to make sure it locks into the position as shown in the picture.

Step 5

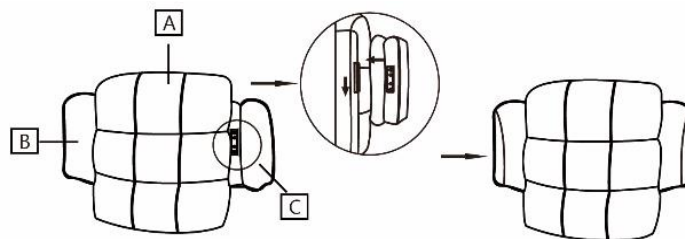

Repeat the process from **Step 3** to attach Right Wing(C) to the right side of Chair Backrest(A).

Step 6

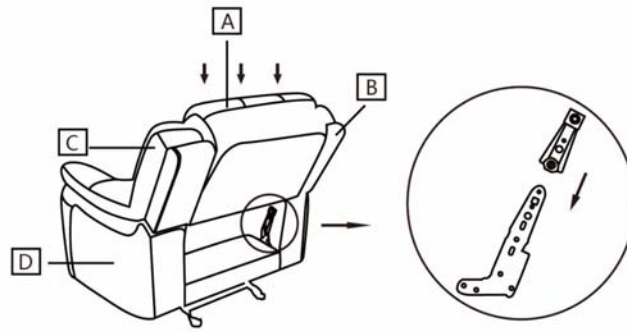

With assistance from your adult partner, hold up the fully assembled Chair Backrest(A) with Wings, and stand behind the Chair. Insert the small metal arms on the sides of the Chair Backrest(A) into the prefabricated slide lock gadget on the Chair Base with Footrest (D) as shown above. Firmly but gently, push the Chair Backrest(A) downwards until it is fully slotted and locked into position.

Step 7

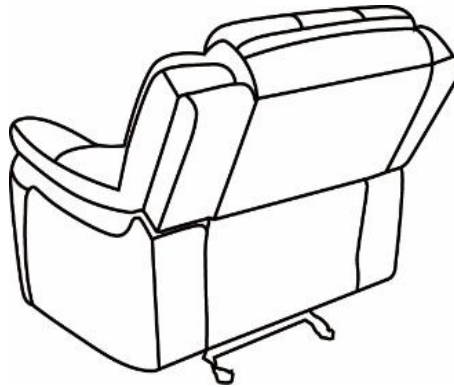

Smooth down the fabric flap on the Chair Backrest(A). Run your hands down both sides of the flap, from top to bottom, allowing the velcro tape to adhere to the flap under the seat of the chair. Your Recliner is ready for use. Caution: This Recliner can only be used on a flat, level surfaces.

User Instructions.

Recliner Chair

Please read the Instruction Manual below carefully before use.

This is a Recliner Chair. At anytime in a reclined seat position or in the upright position. You may enjoy the rocking motion by using your body weight in a back-front rocking motion, and also the swivel motion.

Supervise children, when in use of this Recliner.

To get into a reclined posture - To Recline backrest

Sit into the seat.
Open the trigger on the outside of right armrest.
Use your body weight and push backwards into the seat into a fully reclined position.







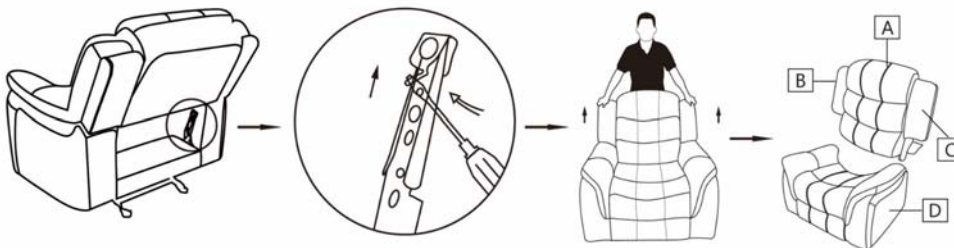
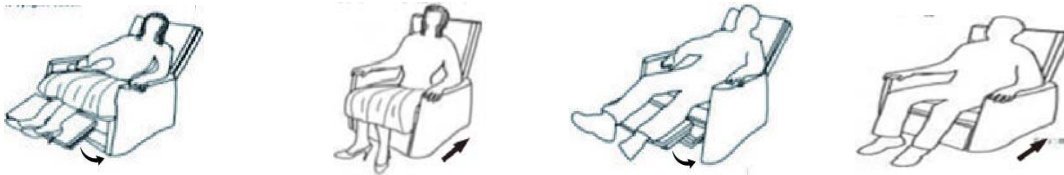





To get out of chair - move Seatback into Upright Position

Tilt your body weight slightly forward and upwards.
The seat back will come up to an upright position.
Use your feet to push the footrest back. You can stand up when the footrest and the mechanism clicked.
Where necessary, use either your arms help lift- push yourself out of the seat.



The way of taking away the Chair Backrest(A) . Open the back flag on the right side, Swing the metal slightly. Pull up the right side of Chair Backrest(A). Then repeat the process to pull up the left side of Chair Backrest(A).

Care & Maintenance

-  Do not put hot items directly on furniture surface
 -  Do not clean furniture with harsh cleansers or polish.
 -  Do not place furniture under direct sunlight.
 -  Do not place furniture near heating or cooling vents.
 -  Do not write on furniture without a padded barrier to protect the surface.
 -  Do not place furniture outside . For indoor use only .
 -  Not for commercial use. For residential use only .
 -  Stains may be removed with mild soap solution and damp cloth.
 -  Children should not climb or jump on the furniture.
-
-  Dust and pick-up spills using a clean, non-colored, lint-free cloth .