

HOME DECORATORS COLLECTION

BF-20191 HAMPTON HARBOR 25 IN. W LINEN CABINE

INV#1002953742/1002953737/1002953889



ASSEMBLY INSTRUCTIONS

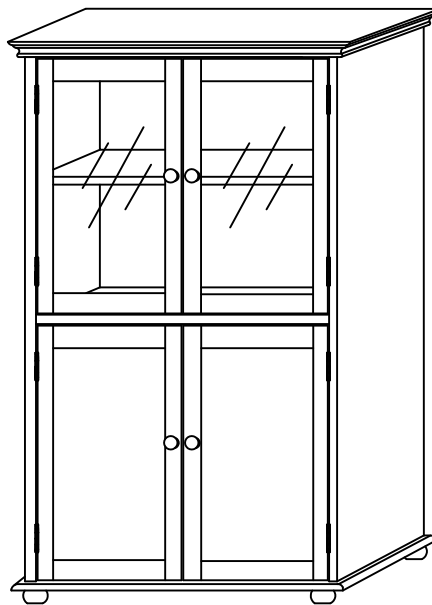





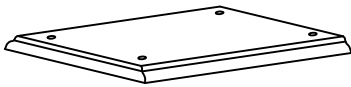

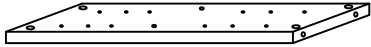
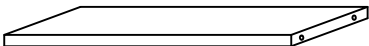
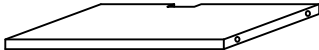
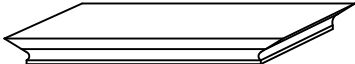
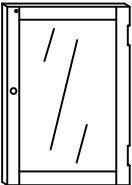
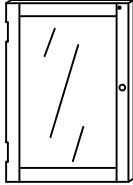
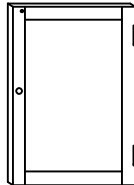
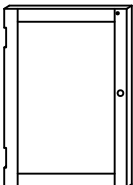
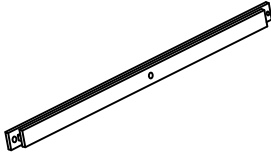
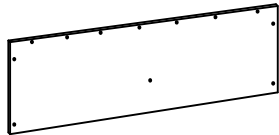

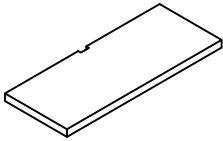

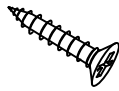
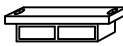
Made In China

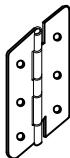

Thank you for purchasing this quality product. Be sure to check all packing material carefully for small parts, which may have come loose inside the carton during shipment. Count all parts and material hardware and then compare with parts list to be sure all parts are present. If any parts are missing or damaged, phone, fax, or mail to our Customer Service Department for efficient and speedy service. Please indicate the model number and code letter of part(s) needed.

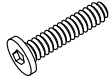
IMPORTANT NOTE: Follow instructions listed below in proper sequence as numbered to assure fast, easy and correct assembly.

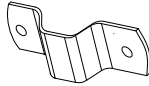
PARTS LIST		
A  BOTTOM PANEL-1PC	B  FEET-4PCS	C  LEFT SIDE PANEL-1PC
D  RIGHT SIDE PANEL-1PC	E  ACROSS PANEL-1PC	F  TOP PANEL-1PC
G  LEFT DOOR-1PC	H  RIGHT DOOR-1PC	I  LEFT DOOR-1PC
J  RIGHT DOOR-1PC	K  REAR PANEL GUIDE-1PC	L  BACK PANELS-2PCS

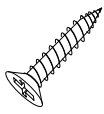
<p>M</p>  <p>SHELVES-2PCS</p>	<p>N</p>  <p>CAM BOLTS-12PCS</p>	<p>O</p>  <p>CAM LOCKS-12PCS</p>	
<p>P</p> <p>6mm × 3/4"</p>  <p>SCREWS-3PCS</p>	<p>Q</p>  <p>LARGE MAGNETS-2PCS</p>	<p>R</p> <p>7mm × 5/8"</p>  <p>SCREWS-32PCS</p>	
<p>S</p> <p>5mm × 1/2"</p>  <p>SCREWS-52PCS</p>	<p>T</p>  <p>HINGES-8PCS</p>	<p>U</p>  <p>FEMALE MAGNETS-4PCS</p>	
<p>V</p>  <p>KNOBS-4PCS</p>	<p>W</p> <p>8mm × 5/8"</p>  <p>SCREWS-4PCS</p>	<p>X</p>  <p>SHELF SUPPORTS-8PCS</p>	
<p>Y</p> <p>11mm × 1-1/4"</p>  <p>SCREWS-4PCS</p>	<p>Z</p>  <p>CAM-TOOL-1PC</p>	<p>A1</p>  <p>ALLEN WRENCH-1PC</p>	<p>B1</p>  <p>HOOKS-4PCS</p>
<p>C1</p>  <p>PLASTIC BELTS-2PCS</p>	<p>D1</p>  <p>GECKOS-4PCS</p>	<p>E1</p> <p>7mm × 7/8"</p>  <p>SCREWS-4PCS</p>	

NOTE: THE SURFACE WITH THE STICKER IS THE BACK SIDE.

NOTE: • UPON OPENING THOROUGHLY CLEAN ALL WOODS SURFACES TO REMOVE DUST AND DIRT THAT MAY HAVE SETTLED ONTO FINISH DURING SHIPMENT. IN ORDER TO PREVENT DAMAGE DURING ASSEMBLY, PLEASE ASSEMBLE THIS ITEM WITH AT LEAST TWO PEOPLE.

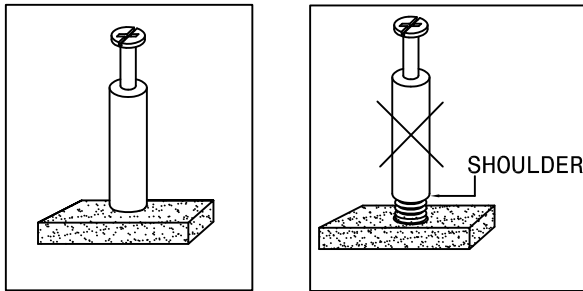

NOTE: TURN THE CAM-BOLT SCREWS UNTIL THEY ARE TIGHT, THE SHOULDER SHOULD BE AGAINST THE SURFACE OF THE PART.

HOW TO USE THE CAM-TOOL

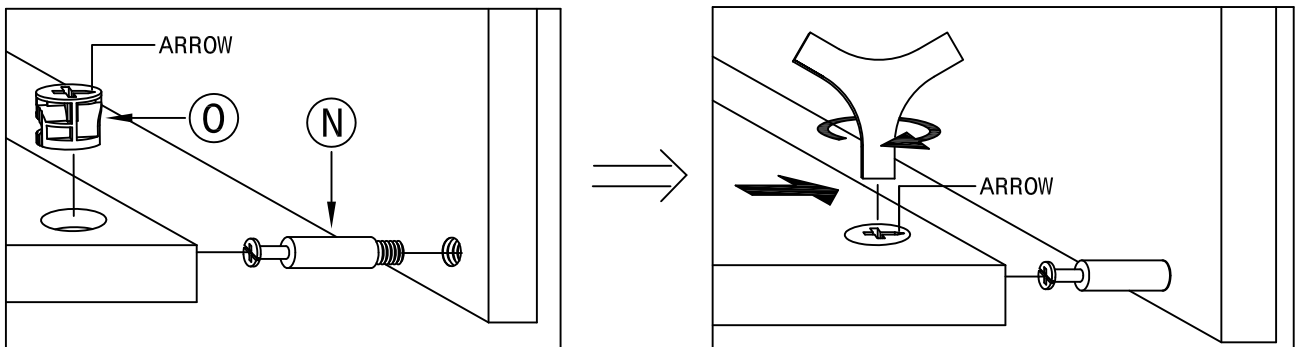

NOTE: • THE ARROWS ON THE HIDDEN CAM-LOCKS SHOULD POINT TO THE CAM-BOLTS

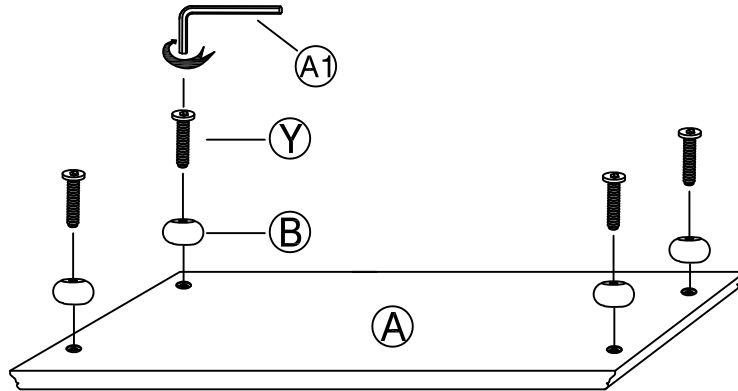

1) . ASSEMBLE THE FEET (B) .

- ATTACH THE FEET (B) TO BOTTOM PANEL (A) USING SCREWS (Y) .

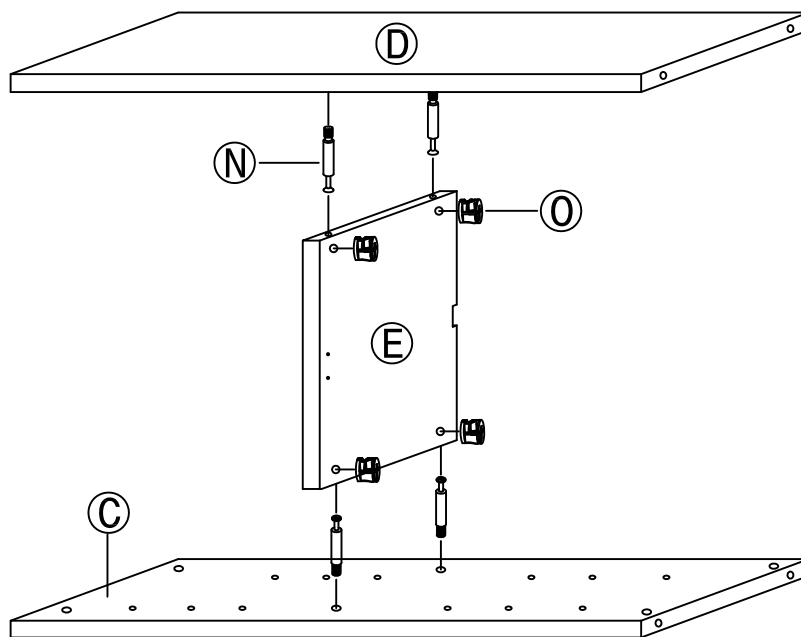

2) . ASSEMBLE THE SIDE PANEL (C/D) .

- ROTATE THE CAM-BOLTS (N) INTO THE HOLES IN THE SIDE PANEL (C/D) .
- PLACE THE CAM-BOLTS (N) INTO THE HOLES IN THE PANEL (E) AND ATTACH USING CAM-LOCKS (O) .

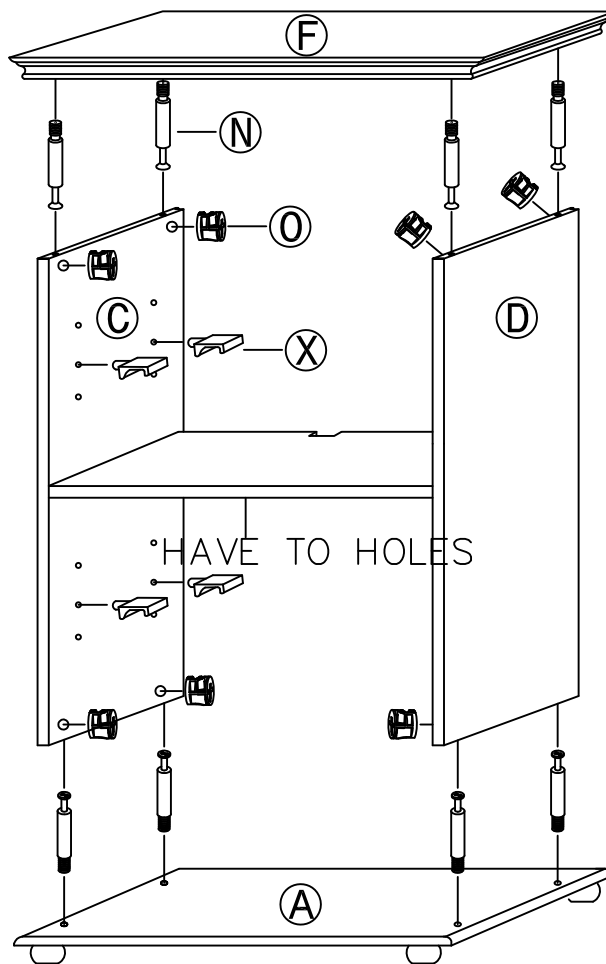

3) . ASSEMBLE THE TOP/BOTTOM PANEL(F/A) .

- ROTATE THE CAM-BOLTS(N) INTO THE HOLES IN THE TOP/BOTTOM PANEL(F/A) .
- PLACE THE CAM-BOLTS(N) INTO THE HOLES IN THE PANEL(C/D) AND ATTACH USING CAM-LOCKS(O) .
- INSERT THE SHELF SUPPORT(X) INTO THE HOLES OF THE SIDE PANEL(C/D) .

Note:When the glass door assemble,please do not run into the glass by hand.
If the glass is dirtied,you can using cleanser purge of glass.

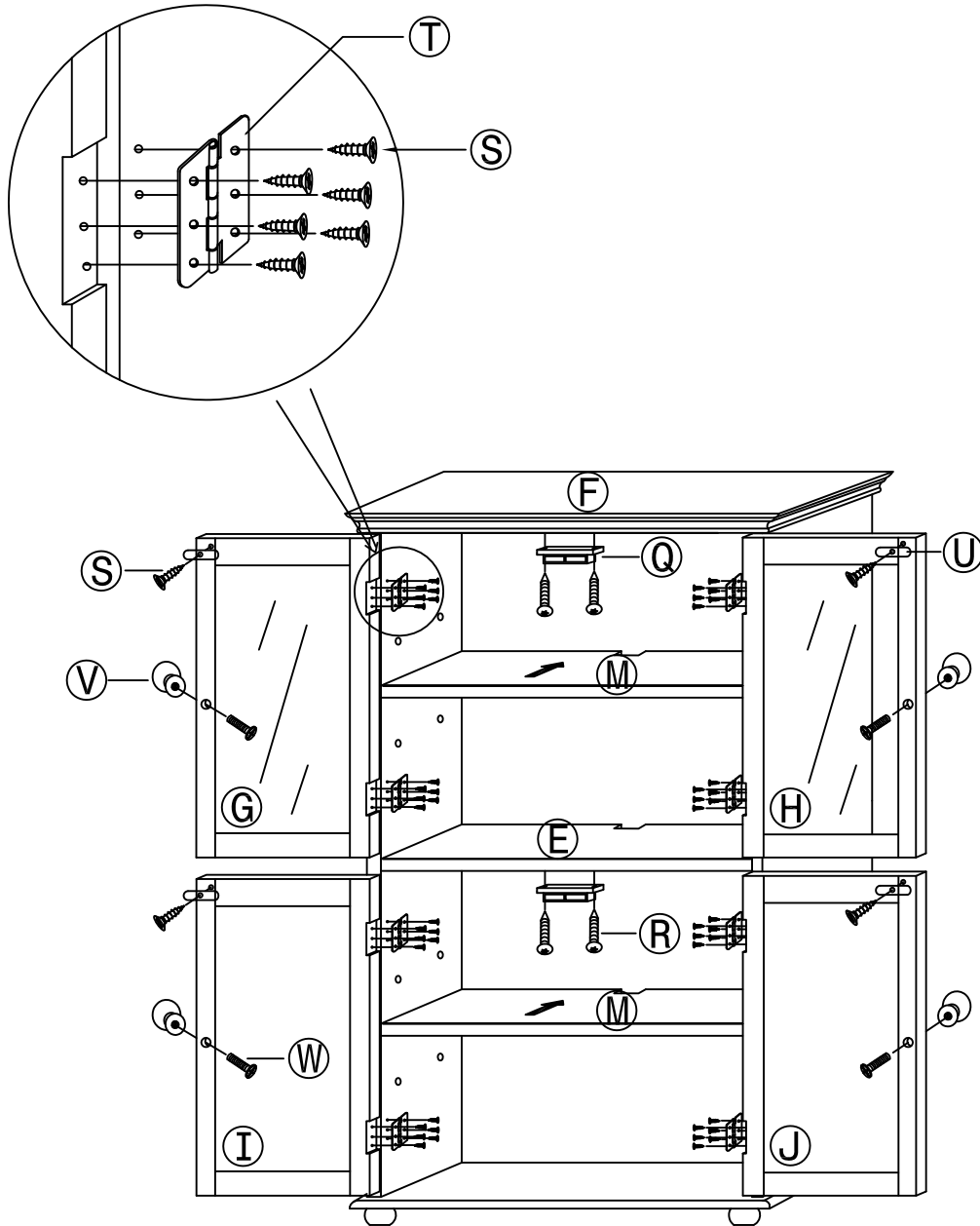

4) . ASSEMBLE THE DOORS(G/H/I/J) AND SHELVES(M).

- ATTACH THE 8 HIGNES(T) TO DOORS(G/H/I/J) AND SIDE PANEL(C/D) USING SCREWS(S) .
- ATTACH THE FEMALE MAGNETS(U) TO THE DOORS(G/H/I/J) USING SCREW(S) .
- ATTACH THE KNOB(V) TO THE DOORS(G/H/I/J) USING SCREWS(W) .
- ATTACH LARGE MAGNET(Q) TO TOP PANEL(F) AND ACROSS PANEL(E) USING SCREWS(R) .
- FINALLY, PUT SHELVES(M) ONTO SHELF SUPPORT(X) .

Note: Before you assemble the back panel, please make sure the doors have an even gap around them. If uneven, shift the unit LEFT OR RIGHT UNTIL the doors are evenly spaced, then attach back panel.

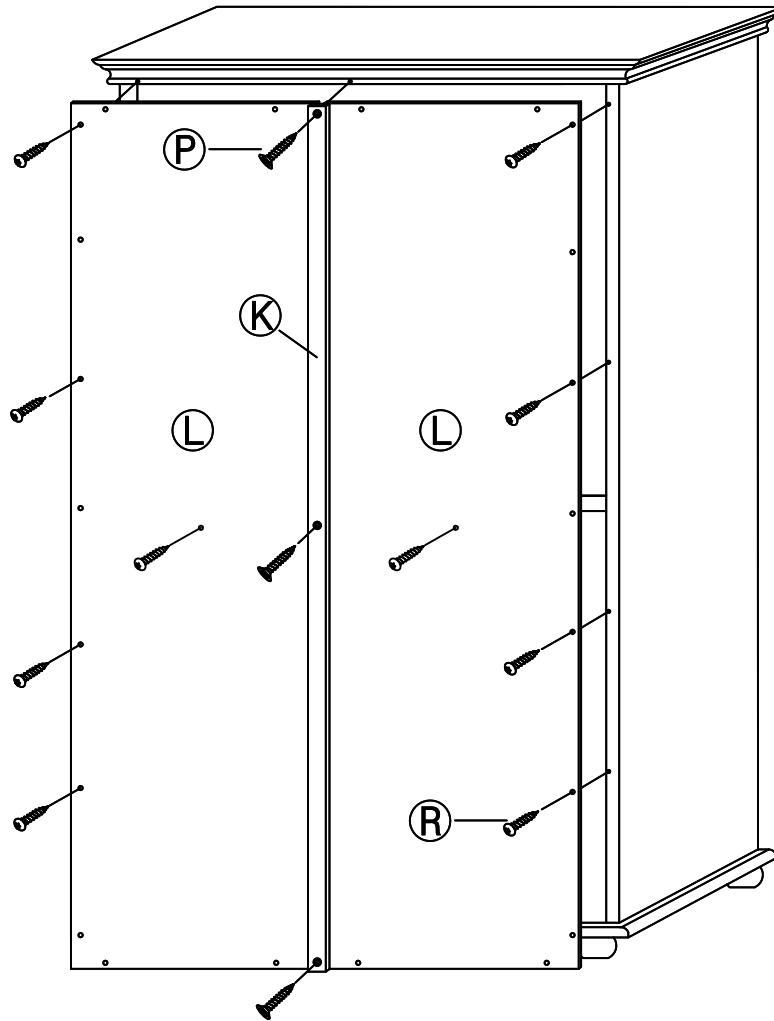

5) . ASSEMBLE THE BACK PANEL(L) .

- INSERT THE BACK PANEL(L) INTO THE SLOT IN THE REAR PANEL GUIDE(K) .
- ATTACH THE BACK PANEL(L) AND REAR PANEL GUIDE(K) USING SCREWS(R/P) .



Warning

The anti-tip hardware must be used as part of assembly!

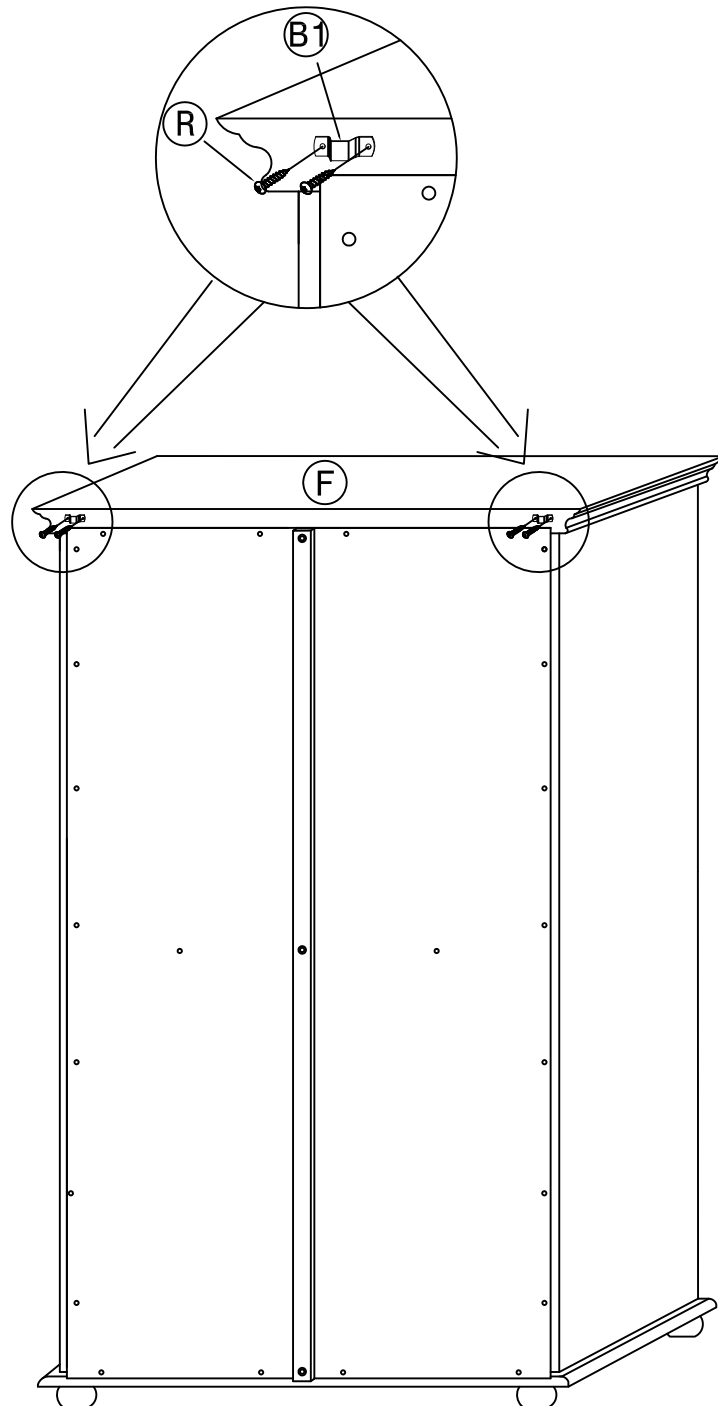

6) . ASSEMBLE THE HOOKS(B1) .

- ATTACH 2 HOOKS(B1) USING 4 SCREWS(R) IN THE PREDRILLED HOLES OF TOP PANEL(F) .

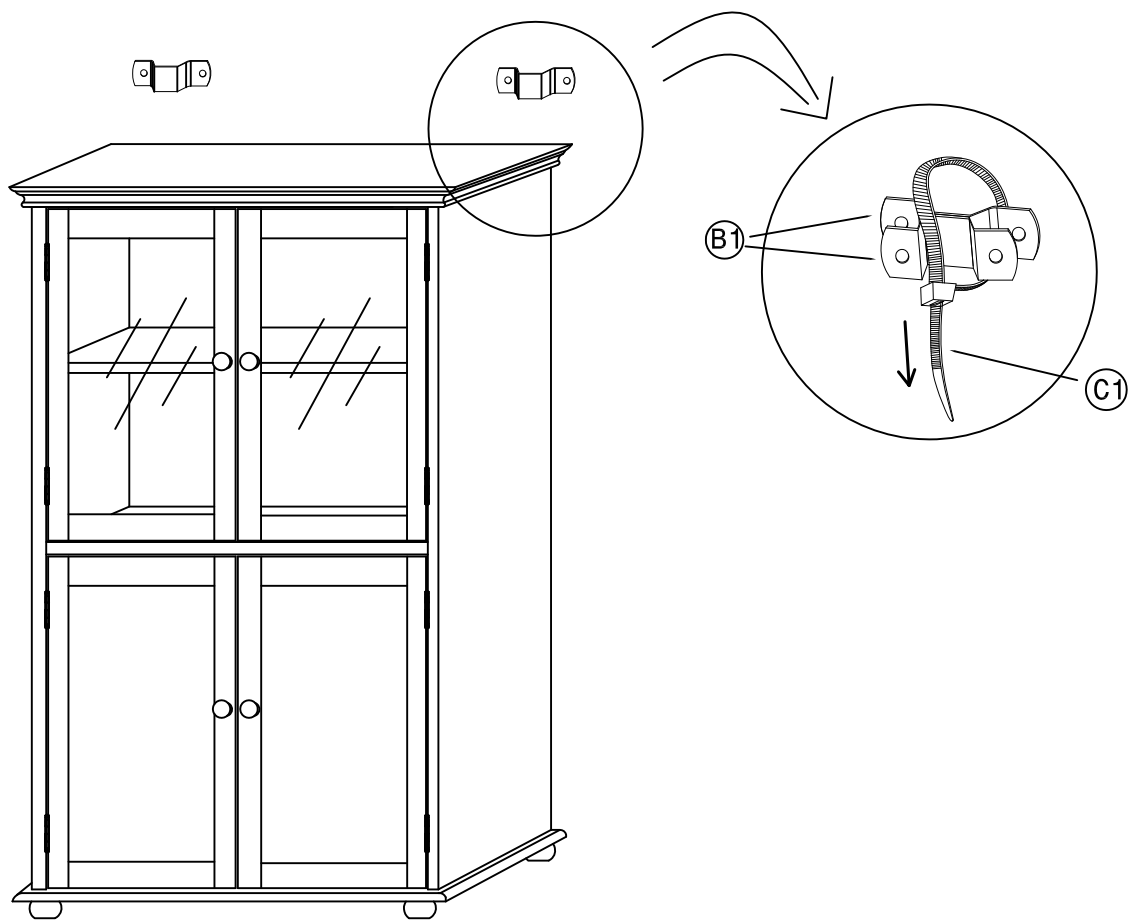
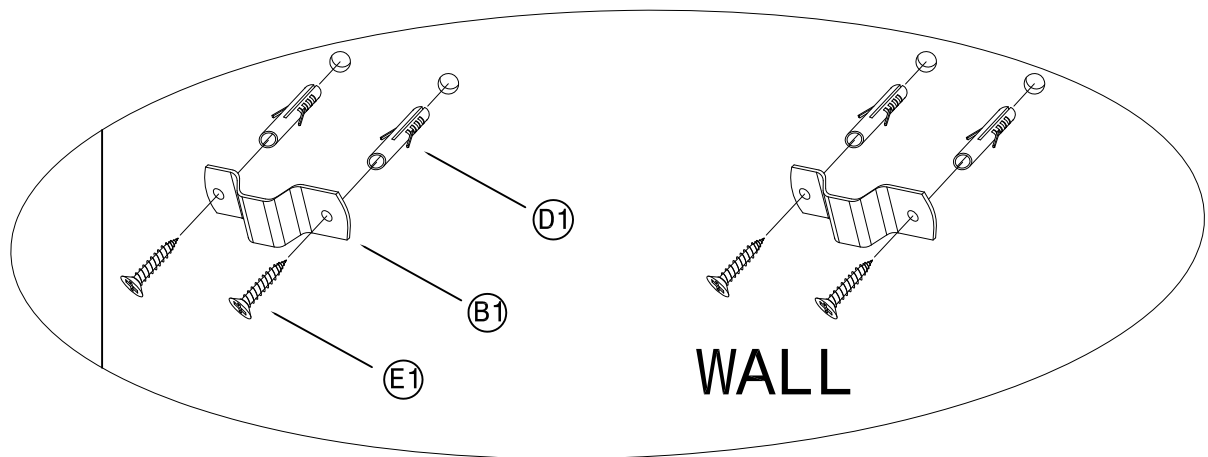

7) . ASSEMBLE THE ANTI-TIP HARDWARE.

- DRILL 4 HOLES INTO THE WALL, PLEASE REFER TO THE REAR TOP PANEL'S HOLE DISTANCE AND HEIGHT.
- PUT 4 GECKOS(D1) INTO THE HOLES IN THE WALL AND ROTATE 4 SCREWS(E1) INTO THE GECKOS(D1).
- CONNECT THE TWO HOOKS(B1) WITH A PLASTIC BELT(C1).

"IMPORTANT HEALTH NOTICE.

SOME OF THE BUILDING MATERIALS USED IN THIS HOME (OR THESE BUILDING MATERIALS) EMIT FORMALDEHYDE. EYE, NOSE, AND THROAT IRRITATION, HEADACHE, NAUSEA AND A VARIETY OF ASTHMA-LIKE SYMPTOMS, INCLUDING SHORTNESS OF BREATH, HAVE BEEN REPORTED AS A RESULT OF FORMALDEHYDE EXPOSURE. ELDERLY PERSONS AND YOUNG CHILDREN, AS WELL AS ANYONE WITH A HISTORY OF ASTHMA, ALLERGIES, OR LUNG PROBLEMS, MAY BE AT GREATER RISK. RESEARCH IS CONTINUING ON THE POSSIBLE LONG-TERM EFFECTS OF EXPOSURE TO FORMALDEHYDE.

REDUCED VENTILATION MAY ALLOW FORMALDEHYDE AND OTHER CONTAMINANTS TO ACCUMULATE IN THE INDOOR AIR. HIGH INDOOR TEMPERATURES AND HUMIDITY RAISE FORMALDEHYDE LEVELS. WHEN A HOME IS TO BE LOCATED IN AREAS SUBJECT TO EXTREME SUMMER TEMPERATURES, AN AIR-CONDITIONING SYSTEM CAN BE USED TO CONTROL INDOOR TEMPERATURE LEVELS. OTHER MEANS OF CONTROLLED MECHANICAL VENTILATION CAN BE USED TO REDUCE LEVELS OF FORMALDEHYDE AND OTHER INDOOR AIR CONTAMINANTS.

IF YOU HAVE ANY QUESTIONS REGARDING THE HEALTH EFFECTS OF FORMALDEHYDE, CONSULT YOUR DOCTOR OR LOCAL HEALTH DEPARTMENT. "