



QUICK START

QUICK START GUIDE • GUÍA DE INICIO RÁPIDO



201067

9000W Open Frame Inverter
Inversor de Armazón Abierto de 9000W

⚠ WARNING:

Read the ENTIRE operator's manual to become familiar with the features of the product before operating.

Failure to operate the product correctly can result in damage to the product, personal property and cause serious injury or even death.

⚠ ADVERTENCIA:

Lea el manual del operador COMPLETAMENTE para familiarizarse con las características del producto antes de operarlo.

La falla en operar el producto correctamente puede resultar en daños al producto, propiedad personal y causar lesiones graves o incluso la muerte.

CHAMPION
GLOBAL POWER EQUIPMENT

www.championpowerequipment.com

© Champion Power Equipment 2021.

All Rights Reserved. / Todos los derechos reservados.

3298-M-OP | REV 20211110



1.

Open shipping carton.  Assembly > Unboxing

Abra el cartón de envío.  Montaje > Desempacando

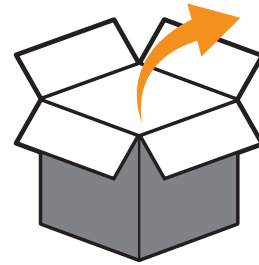

2.

Remove brackets.  Assembly > Remove Shipping Support Brackets.

Remueva las ménsulas.

 Montaje > Remueva las Ménsulas de Soporte de Envío.

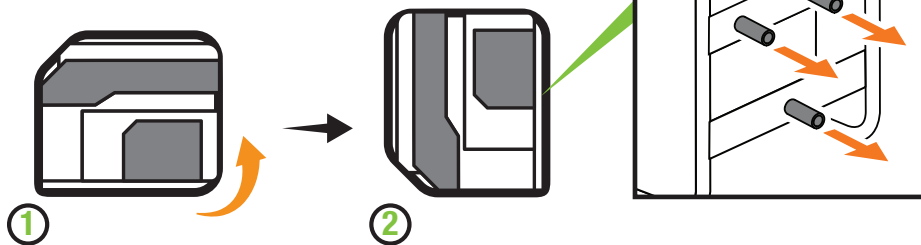

3.

Attach wheel kit.  Assembly > Install Wheel Kit

Fije el juego de ruedas.

 Montaje > Instale el Juego de Ruedas

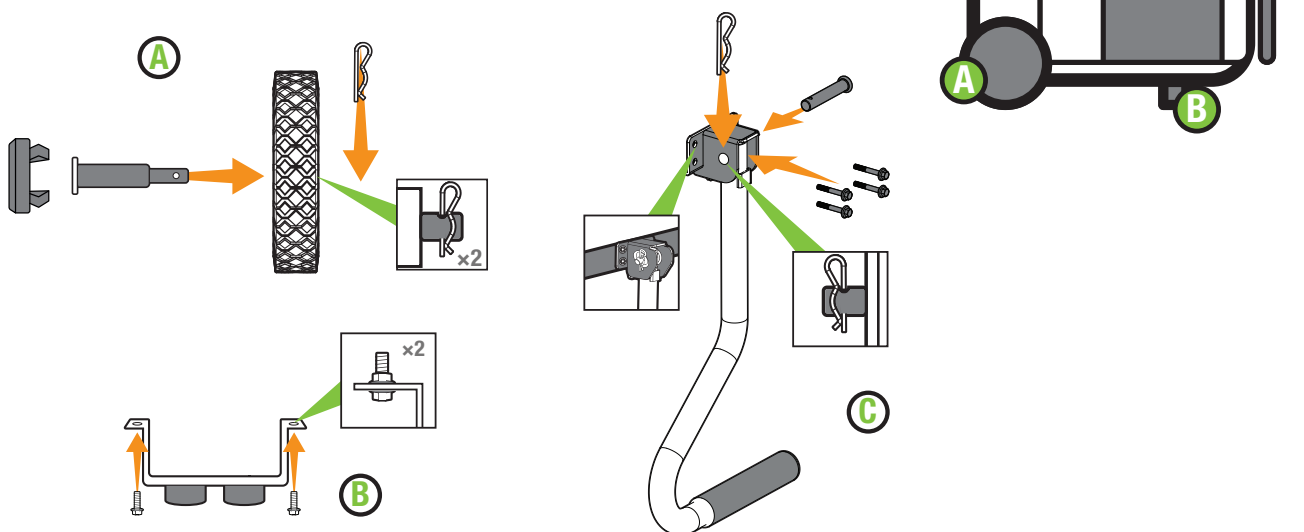

4.

Connect the battery.  Assembly > Connect the Battery.

Cut cable tie on each side of battery connector.
Push two halves of battery connector together tightly.

Conecte la batería.

 Montaje > Conecte la Batería

Cortar la brida de cable a cada lado del conector de la batería.
Empuje dos mitades del conector de la batería firmemente.

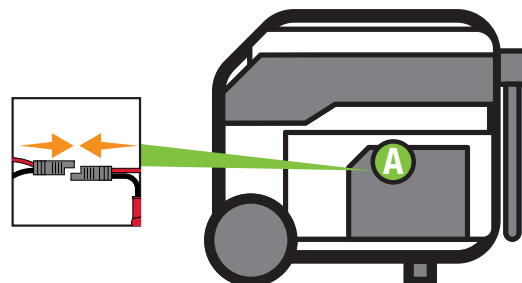

5.

Add oil. 📖 Assembly > Add Engine Oil.

Recommended: 10W-30, up to 37.2 fl. oz. (1100 ml) DO NOT overfill.

Agregue aceite. 📖 Montaje > Agregue Aceite al Motor.

Recomendado: 10W-30, hasta 37.2 fl. oz. (1100 ml) NO sobrellene.

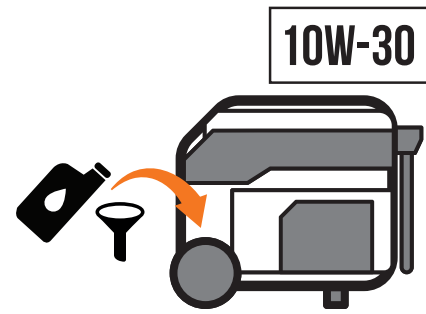

6.

Move the generator outdoors. / Mueva el generador afuera.

Move generator to an open, outdoor area. Point exhaust away. Never run generator in enclosed areas (e.g., not in house or garage).

Mueva el generador a un área abierta al aire libre. Dirija el escape alejado. No opere el generador en áreas cerradas (ej., no en la casa o garaje).

Keep all objects at least 5 feet (1.5 m) from generator. Heat from the muffler and exhaust gas can ignite combustible materials.

Mantenga todos los objetos por lo menos 5 pies (1.5m) del generador. El calor del silenciador y el gas del escape pueden incendiar objetos combustibles.



7.

Add fuel. 📖 Assembly > Add Fuel

DO NOT use E15 or E85.

Agregue combustible.

📖 Montaje > Agregue combustible.

NO use E15 o E85.



8.

DO NOT plug in any electrical devices.

NO enchufe ningún aparato electrónico.



NEVER START OR STOP THE GENERATOR WITH ELECTRICAL DEVICES CONNECTED OR TURNED ON!

¡NUNCA ENCIENDA UN GENERADOR CON APARATOS ELECTRONICOS ENCHUFADOS O ENCENDIDOS!

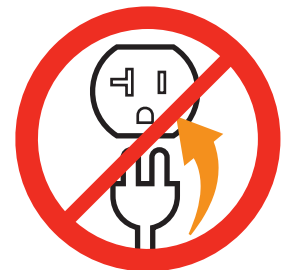

9.

Turn the **fuel valve** “ON”.

Abra la **válvula de combustible** a “ENCENDIDO.”



10a.

Electric Start

1. Pull the **choke knob** out to the “CHOKE” position.
2. Press and hold the **ignition switch** to the “START” position.
3. Push the **choke knob** in to the “RUN” position.

Encendido Eléctrico

1. Jale la **manija del ahogador** a la posición “AHOGAR.”
2. Oprima y mantenga oprimido el **interruptor de arranque** en la posición “ARRANCAR.”
3. Presione la **manija del ahogador** en la posición “CORRER.”

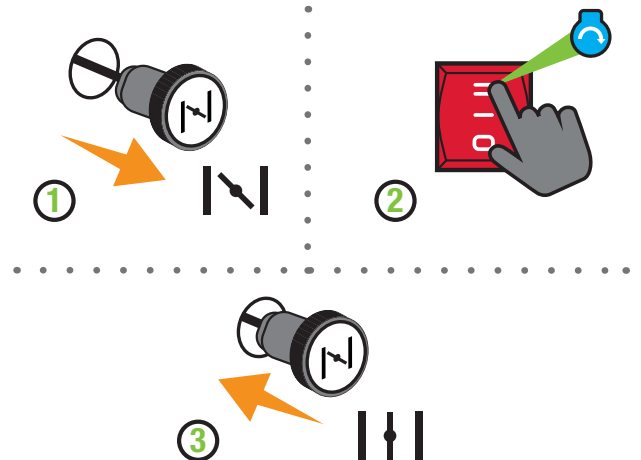

10b.

Manual Start

1. Pull the **choke knob** out to the “CHOKE” position.
2. Push the **ignition switch** to the “ON” position.
3. Pull the **starter cord**.
4. Push the **choke knob** in to the “RUN” position.

Encendido Manual

1. Jale la **manija del ahogador** a la posición “AHOGAR.”
2. Oprima el **interruptor de arranque** a la posición “ENCENDIDO.”
3. Jale el **arrancador retráctil**.
4. Presione la **manija del ahogador** en la posición “CORRER.”

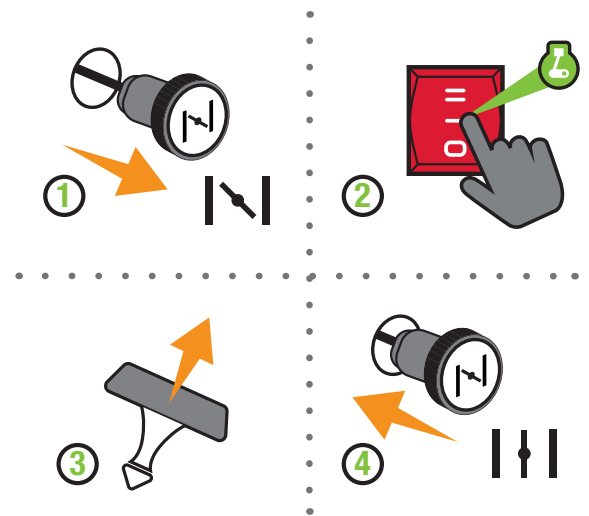

11.

Plug in. 📖 Operation > Connecting Electrical Loads.

Enchufe. 📖 Operación > Conectando Cargas Eléctricas.

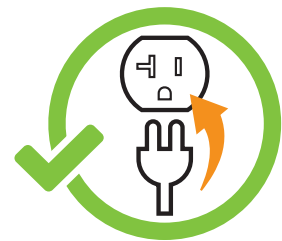

NEED ASSISTANCE OR HAVE A QUESTION?
GIVE US A CALL.

NECESITA AYUDA O TIENE ALGUNA PREGUNTA?
DÉNOS UNA LLAMADA.

📞 1-877-338-0999

CHAMPIONPOWEREQUIPMENT.COM