

Warranty

This product is warranted to the retail consumer for 90 days from date of retail purchase, against defects in material and workmanship.

WHAT IS COVERED

- Replacement parts and labor.
- Transportation charges to customer for the repaired product.

WHAT IS NOT COVERED

- Commercial or industrial use of this product.
- Damage caused by abuse, accident, misuse, or neglect.
- Transportation of the unit or component from the customer to the Master Service Centre.

IMPLIED WARRANTIES

Any implied warranties, including the implied warranty of merchantability are also limited to duration of 90 days from the date of retail purchase.

WARRANTY REGISTRATION

Register on-line at www.koolatron.com AND keep the original, dated, sales receipt with this manual.

WARRANTY AND SERVICE PROCEDURE

If you have a problem with your unit, or you require replacement parts, please telephone the following number for assistance: **1-800-265-8456**

A Master Service Centre must perform all warranty work. Service after warranty may be obtained at a Master Service Centre or at an authorized service dealer. Purchase Receipt is required to establish warranty eligibility.

Master Service Centres at these locations:

U.S.A.

4330 Commerce Dr.
Batavia, NY 14020-4102 U.S.A.

Canada

139 Copernicus Blvd.
Brantford, ON N3P 1N4 Canada



173-bottle DUAL ZONE WINE CELLAR



www.koolatron.com

©2016 Koolatron Corp. All rights reserved.

All specifications are subject to change without notice.

H1S207

05/2016-v1

WC168DZ-B

User Manual

FEATURES

- **free-standing or built-in**
- **compressor based with air cooling**
- capacity (as shown with display shelves) :
upper zone: 33 bottles x 750 mL (25 fl. oz.), lower zone: 88 bottles x 750 mL (25 fl. oz.)
- maximum capacity: 173 bottles
- digitally adjust each zone temperature, °C or °F
 - upper zone 5°C to 9°C (41°F to 48°F)
 - lower zone 9°C to 18°C (48°F to 64°F)
- tinted double panel tempered glass door
- pull out roller assembly for shelves
- dark interior / soft interior light
- locking door

SPECIFICATIONS

Power Requirements:	AC 115V 60Hz 220W
Max. Temp.:	18°C +/- 3°C (64°F +/- 5°F) at 22°C (72°F) ambient air temp.
Min. Temp.:	5°C +/- 3°C (41°F +/- 5°F) at 22°C (72°F) ambient air temp.
Weight:	112 kg (247 lbs)
Refrigerant:	150g R134a

SAFETY

- Household Use Only.
- This unit is an indoor appliance. DO NOT use OUTDOORS.
- Place unit on a flat surface, away from heat sources
- Do not use the appliance if the plug or cable is damaged. If the power cord is damaged and/or is malfunctioning, please contact the manufacturer.
- Pull the plug out of the outlet to disconnect. DO NOT pull the cord.
- Do not touch the plug with wet hands.
- Never clean appliance parts with flammable fluids. Do not store or use gasoline or any other flammable vapors and liquids in the vicinity of this or any other appliance. The fumes can create a fire hazard or explosion.
- Unplug the appliance when not in use.

DANGER: Risk of child entrapment. Before you throw away your old refrigerator or freezer:

- Take off the doors
- Leave the shelves in place so that children may not easily climb inside.

Use of extension cords

Because of potential safety hazards under certain conditions, we strongly recommend against the use of an extension cord. However, if you must use an extension cord, it is absolutely necessary that it is a UL-listed (in the United States) or a CSA-listed (in Canada), 3-wire grounding type appliance extension cord having a grounding type plug and outlet and that the electrical rating of the cord is 15 amperes (minimum) and 120 volts.

TROUBLESHOOTING GUIDE

You can solve many common appliance problems easily, saving you the cost of a possible service call. Try the suggestions below to see if you can solve the problem before calling the

PROBLEM	POSSIBLE CAUSE
Appliance does not operate.	Not plugged in. The circuit breaker tripped or a blown fuse.
Appliance is not cold enough.	Check the temperature control setting. External environment may require a higher setting. The door is opened too often. The door is not closed completely. The door gasket does not seal properly.
Turns on and off frequently.	The room temperature is hotter than normal. The door is opened too often. The door is not closed completely. The temperature control is not set correctly. The door gasket does not seal properly.
The light does not work.	Not plugged in. The circuit breaker tripped or a blown fuse. The bulb has burned out. The switch is in the "OFF" position.
Vibrations.	Check to assure that the appliance is level.
The appliance seems to make too much noise.	The rattling noise may come from the flow of the refrigerant, which is normal. As each cycle ends, you may hear gurgling sounds caused by the flow of refrigerant in your appliance. Contraction and expansion of the inside walls may cause popping and crackling noises. The appliance is not level.
The door will not close properly.	The appliance is not level. The door was reversed and not properly installed. The gasket is dirty. The shelves are out of position.

MAINTENANCE

CLEANING YOUR WINE CELLAR

- Turn off the power, unplug the appliance, and remove all items including shelves and rack.
- Wash the inside surfaces with warm water and baking soda solution. The solution should be about 2 tablespoons of baking soda with a quart of water.
- Wash the shelves with a mild detergent solution.
- Wring excess water out of the sponge or cloth when cleaning area of the controls, or any electrical parts.
- Wash the outside cabinet with warm water and mild liquid detergent. Rinse well and wipe dry with a clean soft cloth.

POWER FAILURE

Most power failures are corrected within a few hours and should not affect the temperature of your appliance if you minimize the number of times the door is opened. If the power is going to be off for a longer period of time, you need to take the proper steps to protect your contents.

VACATION TIME

- Short vacations: Leave the Wine Cellar operating during vacations of less than three weeks.
- Long vacations: If the appliance will not be used for several months, remove all items and turn off the appliance. Clean and dry the interior thoroughly. To prevent door and mold growth, leave the door open slightly: blocking it open if necessary.

MOVING YOUR WINE CELLAR

- Remove all items.
- Securely tape down all loose items (shelves) inside your appliance.
- Turn the adjustable leg up to the base to avoid damage.
- Tape the door shut.
- Be sure the appliance stays secure in the upright position during transportation. Also protect the outside of the appliance with a blanket, or similar item.

ENERGY SAVING TIPS

The Wine Cellar should be located in the coolest area of the room, away from heat producing appliances, and out of the direct sunlight.

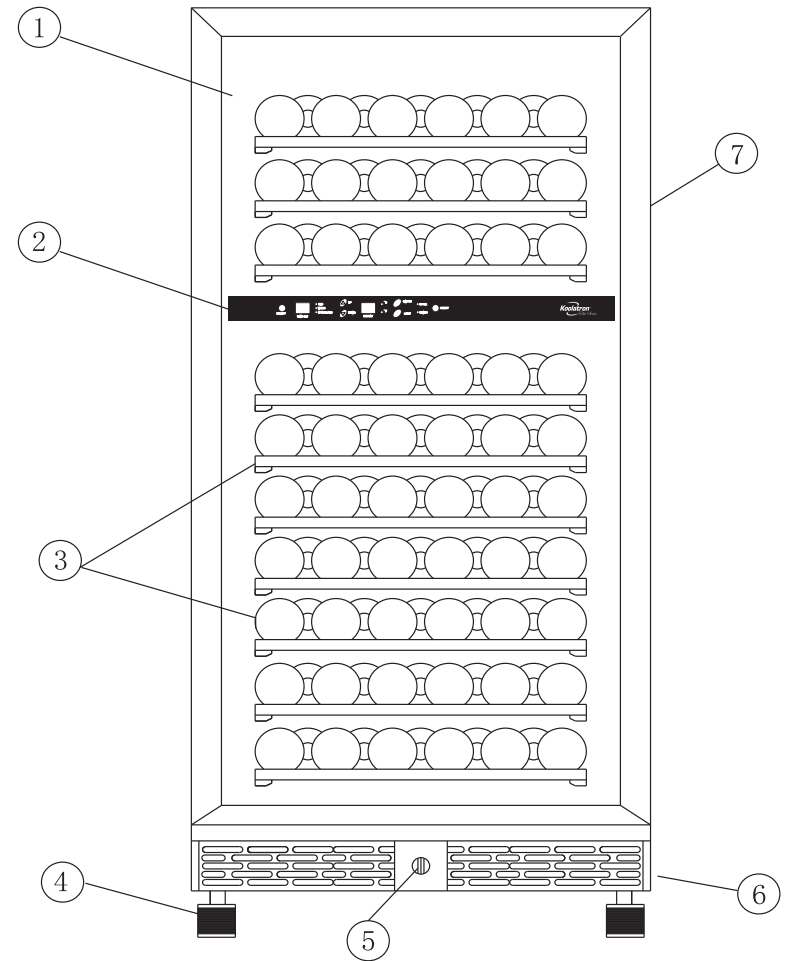

1. Tinted glass door
2. Control panel
3. Wood shelves
4. Foot
5. Door lock
6. Ventilated base
7. Magnetic door seal

INSTALLATION

INSTALLATION DIAGRAM FOR THE BUILT-IN MODELS

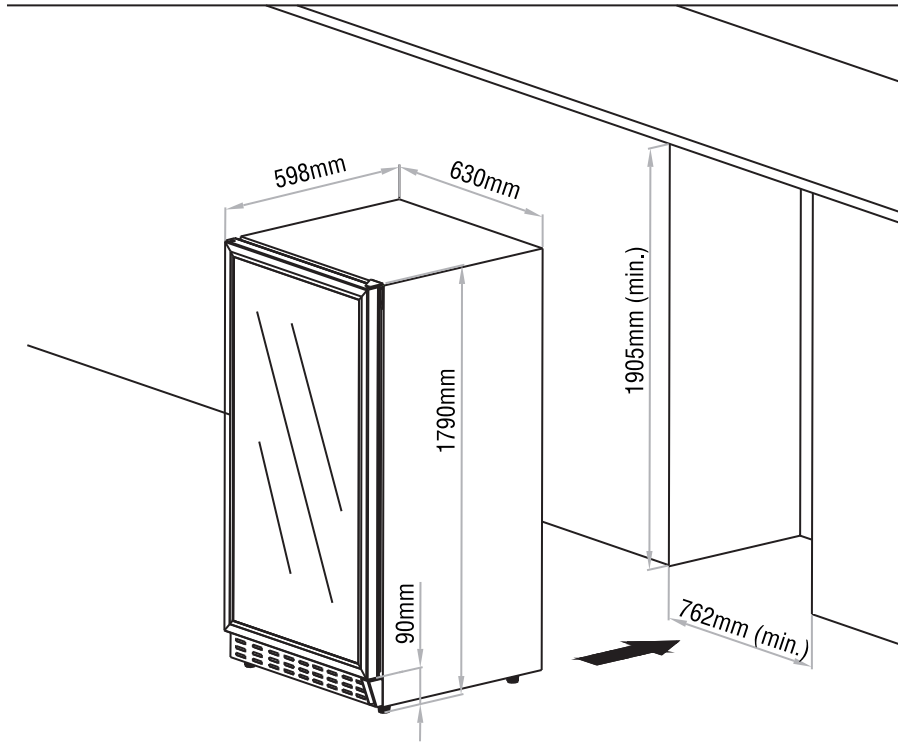

- Level the unit inside the cabinet.
- Open the door of the unit at a 90° angle.
- Fix the facing of the kitchen cabinet on the door of the unit (8 screws included).
- Be sure the gasket seals properly.

LAYOUT AND STORAGE (cont.)

SLIDING SHELF

To move a sliding shelf:

1. Remove all bottles
2. Pull out the shelf
3. Refit them as show below instruction
4. Move out the shelf

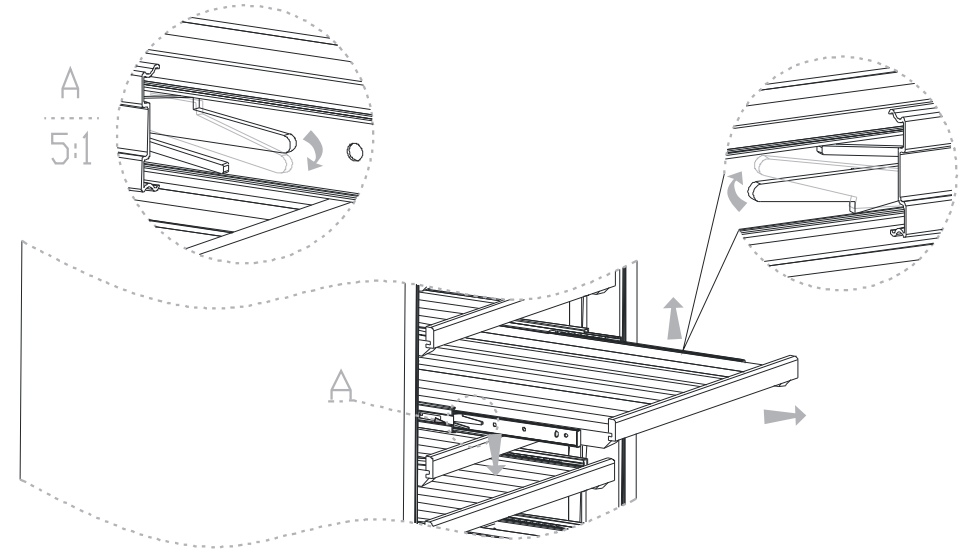

RECOMMENDATIONS FOR LAYOUT AND STORAGE OF YOUR WINE CABINET

Your cabinet was designed to store a maximum number of bottles in total security. We recommend that you observe the tips below to optimize loading.

- Spread your bottles out as evenly as possible over the shelves, so that weight is not concentrated in one point, Also make sure your bottles do not touch the back of the cabinet, or the step at bottom.
- Also make sure that bottles are not all grouped together at the top or bottom of the cabinet.
- Observe the loading instructions provided in section 6, according to the type of storage fixtures with which your cabinet is equipped, and never stack bottles on a sliding shelf.
- Never try to pull out more than one sliding shelf at a time.

PLEASE NOTE

Before modifying your cabinet's original configuration in any way, be sure to ask your deal-

LAYOUT AND STORAGE (cont.)



display shelves



flat shelves

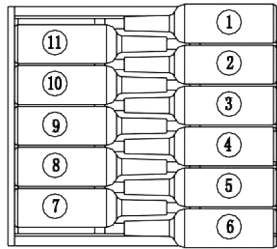

top view

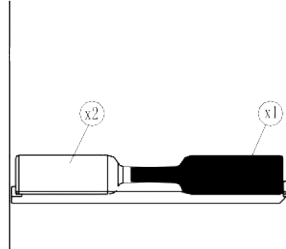

side view



wine glass hanger

INSTALLATION

BEFORE USING YOUR WINE CELLAR

- Remove the exterior and interior packing.
- Before connecting the Wine Cellar to the power source, let it stand upright for approximately 2 hours. This will reduce the possibility of a malfunction in the cooling system from handling during transportation.
- Clean the interior surface with lukewarm water using a soft cloth.
- Install the handle on the left side of the door.

INSTALLATION OF YOUR WINE CELLAR

- This appliance is designed for free standing installation or built-in (fully recessed).
- Place your Wine Cellar on a floor that is strong enough to support it when it is fully loaded. To level your Wine Cellar, adjust the front leveling leg at the bottom of the Wine Cellar.
- Locate the Wine Cellar away from direct sunlight and sources of heat (stove, heater, radiator, etc.). Direct sunlight may affect the acrylic coating and heat sources may increase electrical consumption. Extreme cold ambient temperatures may also cause the unit not to perform properly.
- Avoid locating the unit in moist areas.
- Plug the Wine Cellar into an exclusive, properly installed-grounded wall outlet. Do not under any circumstances cut or remove the third (ground) prong from the power cord. Any questions concerning about power and/or grounding should be directed toward a certified electrician or an authorized products service center.

OPERATING INSTRUCTIONS

The Wine Cellar should be placed where the ambient temperature is between 41°F to 90°F (5°C to 32°C). If the ambient temperature is above or below this range, the performance of the unit may be affected. For example, placing your unit in extreme cold or hot conditions may cause interior temperatures to fluctuate.

RECOMMENDED TEMPERATURES FOR CHILLING WINE

Red Wines: 15-18°C (58-65°F)

White Wines 8-15°C (46-57°F)

The above temperatures may fluctuate depending on whether the interior light is ON or OFF or the bottles are located on the upper/middle/lower section.

TOUCH PANEL

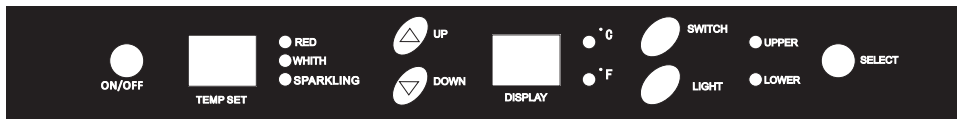

- ON/OFF - Power on and off button. Press the button, it starts; press it again, it stops.
- TEMP SET - temperature setting for the zone selected
- RED - lights up when the temp. is set for red wine temp. range
- WHITE - lights up when the temp. is set for white wine temp. range
- SPARKLING - lights up when the temp. is set for sparkling wine temp. range
- UP - raises the temp. setting
- DOWN - reduces the temp. setting
- DISPLAY - shows actual temperature
- °C/°F - When the °C light is on, it indicates Celsius temperature; when the °F light is on, it indicates Fahrenheit temperature.
- SWITCH - to choose the temp. in °C or °F
- LIGHT - interior light control button. Note: Once the light is turned on, it will automatically turn off after 10 minutes, to protect the wine.
- UPPER - display of the actual temperature of the upper chamber
- LOWER - display of the actual temperature of the lower chamber
- SELECT - for selecting upper or lower zone

OPERATING INSTRUCTIONS (cont.)

- When you use the wine cellar for the first time or restart the wine cellar after having been shut off for a long time, there could be a few degrees variance between the temperature you select and the one indicated on the LED readout. This is normal and it is due to the length of the activation time. Once the wine cellar is running a few hours everything will be back to normal.

INTERIOR LIGHT

You can turn the interior light on or off by pressing the 'LIGHT' button.

DOOR LOCK

This unit has the option to have a lock and key combination.

The keys are located inside the plastic bag that contains the User's Manual. Insert the key into the lock, and turn it counterclockwise to unlock the door. To lock the door, do the reverse operation making sure metal pin is engaged completely. Remove the key and place it in a secure place for safekeeping.

LAYOUT AND STORAGE

Your cabinet was designed to be flexible, to be able to adapt to your requirements.

HOW TO USE YOUR STORAGE SHELF

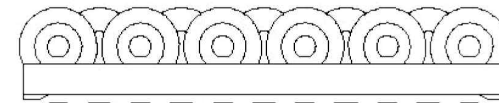

Capacity: 8-22 bottles
Max Weight: 25 kgs