

ASSEMBLY INSTRUCTIONS

300 lb Weight Capacity







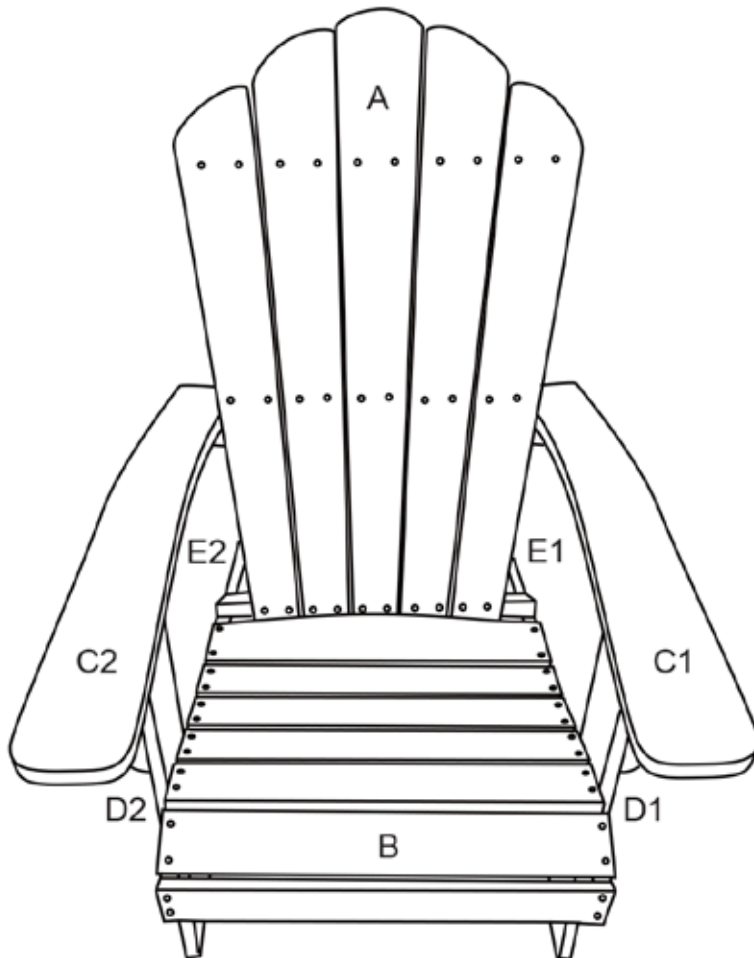





- ADCHAIR1 (BLACK/DRIFTWOOD)
- ADCHAIR3 (BLACK/TAN)
- ADCHAIR5 (WHITE/DRIFTWOOD)

- ADCHAIR2 (BLACK/GREY)
- ADCHAIR4 (WHITE/TAN)

1. Attach Back (#A) and Seat (#B) using Bolt-M6x40mm (#AA).
2. Attach Left Vertical Back Support (#E1) to Left Armrest (#C1) using Bolt-M6x35mm (#BB).
3. Attach Left Front Leg (#D1) to Left Armrest (#C1) using Bolt-M6x35mm (#BB).
4. Attach Left Vertical Back Support (#E1) to Seat (#B) using Bolt-M6x30mm (#CC).
5. Attach Left Front Leg (#D1) to Seat (#B) using Bolt-M6x40mm (#AA).
6. Attach Right Vertical Back Support (#E2) to Right Armrest (#C2) using Bolt-M6x35mm (#BB).
7. Attach Right Front Leg (#D2) to Right Armrest (#C2) using Bolt-M6x35mm (#BB).
8. Attach Right Vertical Back Support (#E2) to Seat (#B) using Bolt-M6x30mm (#CC).
9. Attach Right Front Leg (#D2) to Seat (#B) using Bolt-M6x40mm (#AA).
10. Attach Left Vertical Back Support (#E1) with Right Vertical Back Support (#E2) to Back (#A) using Bolt-M6x40mm (#AA).
11. Hand tighten all bolts in place, then tighten with Hex Wrench (#EE) once fully assembled.



PARTS LIST

A  Back x1	B  Seat x1
C1  Left Armrest x1	C2  Right Armrest x1
D1  Left Front Leg x1	D2  Right Front Leg x1
E1  Left Vertical Back Support x1	E2  Right Vertical Back Support x1
AA  Bolt - M6x40mm x12	BB  Bolt - M6x35mm x4
CC  Bolt - M6x30mm x4	EE  Hex Wrench x1

ASSEMBLY INSTRUCTIONS

NOTE: Hand tighten all bolts in place, then tighten with hex wrench when fully assembled.

