

STAIR-NOSING PROFILES



INNOVATIVE SOLUTIONS FOR CERAMIC AND STONE TILE

FINISHING, EDGE PROTECTION, VISUAL ENHANCEMENT, AND SLIP-RESISTANCE

Ceramic and stone tiles are brittle materials whose exposed edges are prone to cracking and chipping when left unprotected. Tiled stair edges that do not utilize appropriate trim pieces are left vulnerable to chipping and breaking and can create a slip hazard, especially in exterior applications. Schluter® stair-nosing profiles protect exposed tile edges and improve safety on tiled stairways by providing slip-resistant wear surfaces and increased visibility in both residential and commercial applications.

Application and Function

Residential Applications

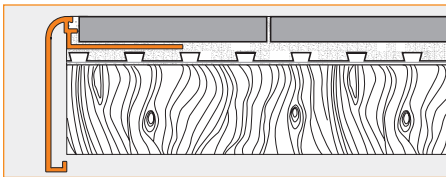

2.8 Schluter®-RODEC-STEP is a finishing and edging profile for ceramic tile and natural stone installations on stairs and countertops. The profile features a trapezoid-perforated anchoring leg, which is secured in the mortar bond coat beneath the tile. The top of the profile features a symmetrically rounded edge with 1/4" (6 mm) radius, which matches the RONDEC profile, while the vertical leg of the profile hides the exposed edge of the sub-assembly. In addition, the profile effectively protects tiles in the edge area from mechanical and impact stresses. The integrated joint spacer establishes a defined joint cavity between the tile and the profile. RONDEC-STEP is suitable for residential applications, e.g., stairs not exposed to heavy traffic, and countertops. RONDEC-STEP is available in two vertical leg lengths, 1-1/2" (39 mm) and 2-1/4" (57 mm), to cover the

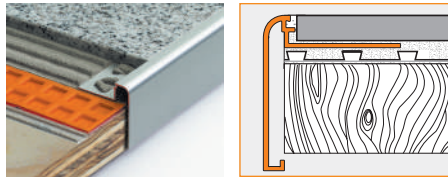

2.8 Schluter®-RODEC-STEP

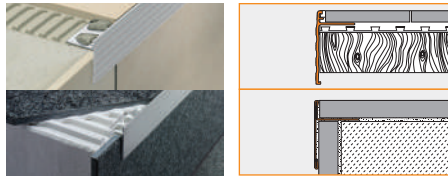

2.11 Schluter®-SCHIENE-STEP



3.4 Schluter®-TREP-FL

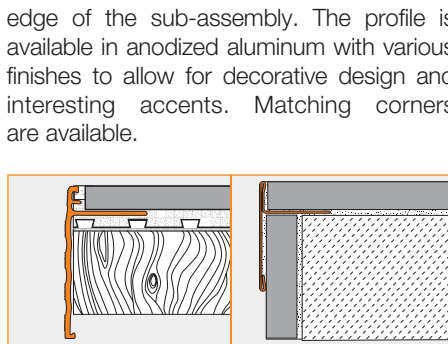

2.11 Schluter®-SCHIENE-STEP is a finishing and edging profile for ceramic tile and natural stone installations on countertops, stairs, and tile over tile applications on walls. The profile features a trapezoid-perforated anchoring leg, which is secured in the mortar bond coat beneath the tile. The top of the profile features a vertical wall section that finishes and protects the tile from damage,

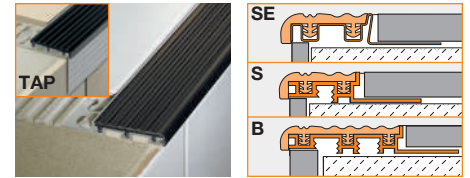

3.2 Schluter®-TREP-SE/-S/-B

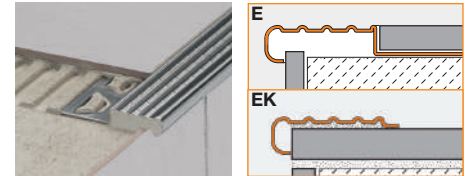

3.3 Schluter®-TREP-E/-EK

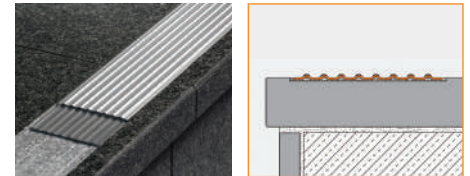

3.3 Schluter®-TREP-EFK

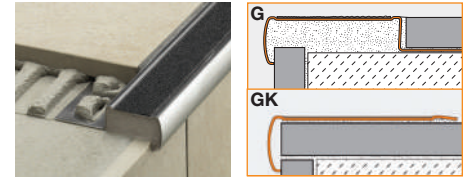

3.5 Schluter®-TREP-G/-GK

while the vertical leg covers the edge of the sub-assembly, top of the riser, or existing wall tile edge.

SCHIENE-STEP is available in anodized aluminum and brushed stainless steel versions, which have different shapes and intended uses. The stainless steel version is available in three vertical leg lengths: 1-1/2" (39 mm) for countertops, 1-3/16" (30 mm) for stairs, and 7/16" (11 mm) for tile over tile applications. Matching inside and outside corners and connectors are available, depending on the vertical leg length. The anodized aluminum version is



intended for residential stair applications (stairs not exposed to heavy traffic). It is available in two vertical leg lengths, 1-3/16" (30 mm) and 1-1/2" (39 mm), to cover the edge of the sub-assembly. The integrated joint spacer establishes a defined joint cavity between the tile and the profile. Accessories are not available for the anodized aluminum version.

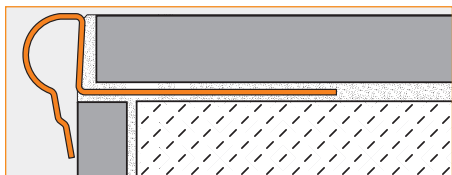

3.4 Schluter®-TREP-FL is a decorative stair-nosing profile with a protruding rounded edge that can be integrated into stairs covered with ceramic tile or natural stone. The profile protects the front edge of stairs and adds a high degree of safety by improving the visibility of the stair edges. The profile is available in stainless steel or anodized aluminum. TREP-FL is suitable for residential applications, e.g., stairs not exposed to heavy traffic. Matching end caps are available.

Commercial Applications

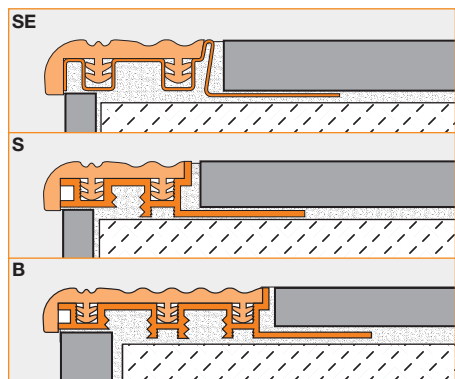

3.2 Schluter®-TREP-SE/-S/-B are designed to protect tiled stair edges and provide an easily visible, slip-resistant wear surface for durable, safe, and visually appealing stair-nosing design. They are suitable for use in areas subjected to heavy foot-traffic, such as offices or public buildings. The profiles feature a trapezoid-perforated anchoring leg made of stainless steel (TREP-SE) or aluminum (TREP-S and TREP-B), which is secured in the mortar bond coat beneath the tile and supports a slip-resistant thermoplastic rubber wear surface. The tread surface of TREP-SE/-S/-B is available in a variety of colors and can be replaced in case of damage or wear. TREP-B features a 2-1/8" (52 mm)-wide wear surface, allowing the designer to easily

produce stairs with the first and last steps marked by a 2" (50 mm)-wide strip in a contrasting color to increase visibility and safety. The leading edges of TREP-S/-SE/-B have a 5/16" (8 mm) radius. Matching end caps are available.

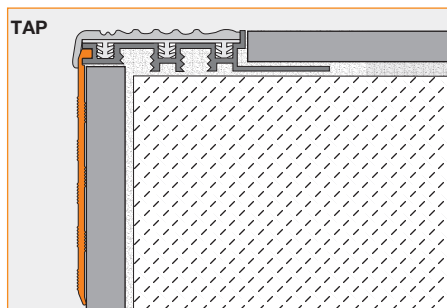

3.1 Schluter®-TREP-TAP is an anodized aluminum cover profile that integrates with the TREP-S/-B stair-nosing profiles to conceal the top of the riser. Two options are available: a 2-13/32" (61 mm) version featuring a horizontal groove, and a 2" (50 mm) version features a smooth surface finish.

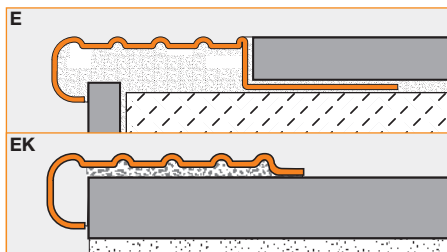

3.3 Schluter®-TREP-E is designed to protect tiled stair edges and provide an easily visible, slip-resistant wear surface for durable, safe, and visually appealing stair-nosing design. The profile is made of attractive and durable stainless steel, making it particularly suited for areas subjected to heavy foot traffic, such as offices or public buildings. The profile can be integrated into stairs covered with ceramic tile or natural stone, as well as into a screed or a surface coating that is a minimum 3/32" (2 mm) thick via the trapezoid-perforated anchoring leg. When integrated into screed layers, the anchoring leg of the profile must be covered with at least 9/16" (15 mm) of mortar. **Schluter®-TREP-EK** is a variant without an anchoring leg. TREP-EK is adhered to existing steps, e.g., for retrofitting over damaged edges, eliminating the need to replace the entire step. Matching end caps are available.

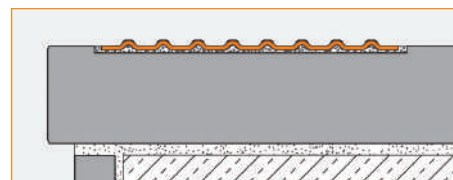

3.3 Schluter®-TREP-EFK is a retrofit stainless steel stair profile which is bonded to existing steps. The stair profile features an easily visible, slip-resistant wear surface for durable and safe stairs. The profile is suitable for interior and exterior use in areas subjected to heavy foot traffic, such as offices or public buildings. The profile is typically adhered within a recessed area on stair treads covered with natural stone or constructed of concrete. It may also be applied to the surface of existing stair treads covered with ceramic or porcelain tile.

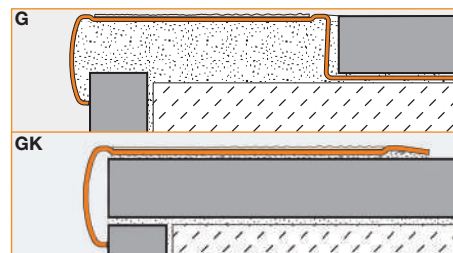

3.5 Schluter®-TREP-G is designed to protect tiled stair edges and provide an easily visible, slip-resistant wear surface for durable, safe, and visually appealing stair-nosing design. The profile is made of attractive and durable stainless steel with a special slip-resistant tread, making it particularly suited for areas subjected to heavy foot traffic, such as offices or public buildings. The surface features a self-adhesive, slip-resistant tread with an embedded mineral grain coating. The treads are available in a variety of colors and can be replaced in case of damage or wear. The profile can be integrated into stairs covered with ceramic tile or natural stone, as well as into a screed or surface coating. **Schluter®-TREP-GK** is a variant of the profile without an anchoring leg. TREP-GK is adhered to existing steps, e.g., for retrofitting over damaged edges, eliminating the need to replace the entire step. TREP-G is available in 1-3/16" (30 mm) and 2-5/32" (55 mm) widths, while TREP-GK is available in 1-11/32" (34 mm) and 2-21/64" (59 mm) widths. Matching end caps are available.



Material Properties and Areas of Application

Schluter® stair-nosing profiles are resistant to most chemicals encountered in tiled environments. In special cases, the suitability of a proposed type of material must be verified based on the anticipated chemical, mechanical, and/or other stresses. Exceptions and special considerations are listed below.

Stainless steel profiles are roll-formed, resulting in a slightly different contour from those made of extruded brass or aluminum. Stainless steel can sustain high mechanical stresses and is particularly well suited for applications requiring resistance against chemicals and acids; for example in the food industry, breweries, dairies, commercial kitchens, and hospitals, as well as in residential applications. Typically, the profiles are formed using stainless steel 304 (1.4031 = V2A). For more severe chemical exposure, such as de-icing salts and chemicals used in swimming pools, we recommend the use of stainless steel 316 L (1.4404 = V4A), which offers even higher corrosion resistance than the 304. Even stainless steel cannot withstand all chemical exposures, such as hydrochloric acid, hydrofluoric acid or certain chlorine, chloride, and brine concentrations. Both stainless steel 304 and stainless steel 316 L are approved for use in exterior applications. Stainless steel 304 is not as corrosion resistant as 316 L; however, profiles in stainless steel 304 are acceptable for exterior use as long as the intended area is not susceptible to de-icing salts, chlorine, or saltwater.

Aluminum profiles must be tested to verify their suitability if chemical stresses are anticipated. Cementitious materials, in conjunction with moisture, become alkaline. Since aluminum is sensitive to alkaline substances, exposure to the alkali (depending on the concentration and duration of exposure) may result in corrosion (aluminum hydroxide formation). Therefore, it is important to remove mortar or grout residue from visible surfaces. In addition, ensure that the profile is solidly embedded in the setting material and that all cavities are filled to prevent the collection of alkaline water.

Anodized aluminum profiles feature an anodized layer that retains a uniform appearance during normal use, but is not color-stable in exterior applications. The surface is susceptible to scratching and wear and may be damaged by grout or setting material. Therefore, these materials must be removed immediately. Otherwise, the description regarding aluminum applies.

Thermoplastic rubber inserts are highly resistant to chemicals and can withstand chemical stresses typically encountered in tiled environments.

Mineral grain coated treads are resistant to heavy mechanical stresses and can withstand chemical stresses typically encountered in tiled environments. They can be used for interior and exterior applications, except for the transparent tread that has limited UV resistance and is intended for interior use only.

Due to variations in raw materials and manufacturing, the exact color, shade, and/or texture of individual profiles may vary. The customer must inspect the products upon delivery and notify Schluter in writing of any physical damage to the products or nonconformity with the purchase order or invoice.

Cutting Profiles

Observe all safety instructions and standards as directed by the cutting tool manufacturer, including protective eyewear, hearing protection, and gloves.

Always measure carefully and dry fit the profiles, corners, and connectors to ensure proper fit and alignment prior to setting tile.

Aluminum profiles may be cut using any of the following options:

- **Hacksaw** with a bimetal blade and the highest teeth per inch (TPI) available.
- **Variable-Speed Angle Grinder** set to the lowest speed using the Schluter®-PROCUT-TSM cutting wheel.
- **Chop saw or Miter Saw** with a non-ferrous blade.

Regardless of the cutting tool used, remove any burrs from the cut end of the profile with a file or similar before installation.

Stainless steel profiles may be cut using any of the following options:

- **Variable-Speed Angle Grinder** set to the lowest speed using the Schluter®-PROCUT-TSM cutting wheel.
- **Band Saw** with a metal cutting blade.

Regardless of the cutting tool used, remove any burrs from the cut end of the profile with a file or similar before installation.

Installation

RONDEC-STEP and SCHIENE-STEP

1. Select the profile according to the tile thickness and format and the sub-assembly thickness.
2. Using a notched trowel, apply thin-set mortar over the area where the trapezoid-

perforated anchoring leg will be placed. For SCHIENE-STEP, apply several beads of KERDI-FIX or similar to the back side of the vertical wall section of the profile.

3. Press the perforated anchoring leg of profile into the thin-set mortar and align.
4. Trowel additional thin-set mortar over the perforated anchoring leg to ensure full coverage and support of the tile edges.
5. Solidly embed the tiles so that the tiled surface is flush with the top of the profile; the profile should not be higher than the tiled surface, but rather up to approximately 1/32" (1 mm) lower.
6. Set the tile to the integrated joint spacer, which ensures a uniform joint of 1/16" – 1/8" (1.5 – 3 mm).
7. Fill the joint completely with grout or setting material.
8. Work with materials and tools that will not scratch or damage sensitive surfaces. Setting materials must be removed immediately, especially from aluminum.

Note: Matching corners are available for RONDEC-STEP. Matching corners and connectors are available for the stainless steel version of SCHIENE-STEP only, depending on the vertical leg length.

RONDEC-STEP corners are held in place with thin-set mortar. Fill the ends of the profile with thin-set mortar prior to inserting the accessories.

SCHIENE-STEP corners and connectors are installed using KERDI-FIX, silicone, or similar adhesive. Prior to application, any contact-inhibiting substances (e.g., grease, etc.) must be removed. The accessories should overlap the profiles by at least 3/8" (10 mm). The accessories must be slid on the profiles during profiles installation (cannot be placed over the profiles after installation).

TREP-FL, TREP-SE/-S/-B, TREP-E and TREP-G

1. Select profile size according to tile thickness and format.
2. Install riser tile flush with the stair tread surface.
3. Using a notched trowel, apply thin-set mortar along edge area above riser.
4. Fill cavities on the underside of the profile with thin-set mortar.
5. Press the trapezoid-perforated anchoring leg of the profile into the thin-set mortar, making sure the front edge of the support section is aligned flush with the riser tile (Exception: TREP-E, TREP-FL and TREP-G are installed such that the front edge of the profile overlaps the riser tile). Full coverage must be obtained at the edge area to ensure support of the profile.



6. Trowel additional thin-set mortar over the anchoring leg and the stair tread surface to ensure full coverage and support of the tile edges.
7. Solidly embed the tread tiles so that the tiled surface is flush with the top of the profile.
8. A joint of approx. 1/16" - 1/8" (1.5 - 3 mm) should be left between the tile and the profile.
9. Fill joint completely with grout or setting material.

Notes: When using TREP-TAP, apply Schluter®-KERDI-FIX or similar adhesive to the riser and insert the cover profile in the support section of TREP-S/-B prior to installing the stair-nosing profile. TREP-TAP should not be used where it can extend past the bottom of the riser.

TREP-EK and TREP-GK

1. Clean the stair nosings and repair damaged areas if applicable.
2. Clean or degrease the underside of the profile.

3. Adhere the profile by fully embedding it into a suitable adhesive (e.g., epoxy resin or KERDI-FIX, depending on the substrate).

Note: The upper profile edge of TREP-EK is approximately 3/32" (2.5 mm) higher than the stair covering, while the upper profile edge of TREP-GK is approximately 1/16" (1.5 mm) higher than the stair covering.

TREP-EFK

1. TREP-EFK may be adhered to a recessed area in the stair tread or on the surface of the tread.
2. Clean the stair tread and repair damaged areas if applicable.
3. Clean or degrease the underside of the profile.
4. Adhere the profile by fully embedding it into a suitable adhesive (e.g., epoxy resin or KERDI-FIX, depending on the substrate).

Note: The upper profile edge of TREP-EFK is approximately 3/32" (2 mm) higher than

the stair covering if not installed within a recessed area.

Maintenance

Schluter® stair-nosing profiles require no special maintenance or care and are resistant to mold and fungi. Clean profiles periodically using pH neutral cleaning agents.

Stainless steel surfaces exposed to the environment or aggressive substances should be cleaned periodically using a pH neutral cleaner. Regular cleaning maintains the neat appearance of stainless steel and reduces the risk of corrosion. All cleaning agents must be free of hydrochloric acid, hydrofluoric acid, and chlorides. Stainless steel surfaces develop a sheen when treated with a chrome-polishing agent.

Oxidation films on **aluminum** may be removed with a conventional polishing agent, but the film will form again.

In the case of **anodized aluminum**, do not use abrasive or strong alkaline cleaning agents.

The treads of TREP-SE/-S/-B/-G/-GK can be replaced in case of damage or wear.

Product Item Numbers

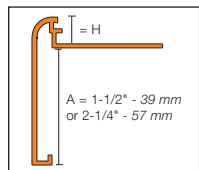
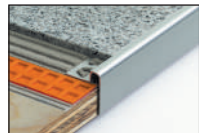

2.8 Schluter®-RONDEC-STEP

H = mm - in.	Item No.						
	Satin anodized aluminum (AE)	Brushed chrome anodized aluminum (ACGB)	Satin nickel anodized aluminum (AT)	Brushed nickel anodized aluminum (ATGB)	Satin copper anodized aluminum (AK)	Brushed copper anodized aluminum (AKGB)	
A: 39 mm - 1-1/2"							
8 - 5/16	RS 80 AE 39	RS 80 ACGB 39	RS 80 AT 39	RS 80 ATGB 39	RS 80 AK 39	RS 80 AKGB 39	
10 - 3/8	RS 100 AE 39	RS 100 ACGB 39	RS 100 AT 39	RS 100 ATGB 39	RS 100 AK 39	RS 100 AKGB 39	
12.5 - 1/2	RS 125 AE 39	RS 125 ACGB 39	RS 125 AT 39	RS 125 ATGB 39	RS 125 AK 39	RS 125 AKGB 39	
A: 57 mm - 2-1/4"							
8 - 5/16	RS 80 AE 57	RS 80 ACGB 57	RS 80 AT 57	-	RS 80 AK 57	RS 80 AKGB 57	
10 - 3/8	RS 100 AE 57	RS 100 ACGB 57	RS 100 AT 57	-	RS 100 AK 57	RS 100 AKGB 57	
12.5 - 1/2	RS 125 AE 57	RS 125 ACGB 57	RS 125 AT 57	-	RS 125 AK 57	RS 125 AKGB 57	

H = mm - in.	Item No.		
	Satin brass anodized aluminum (AM)	Brushed brass anodized aluminum (AMGB)	Brushed antique bronze anodized aluminum (ABGB)
A: 39 mm - 1-1/2"			
8 - 5/16	-	RS 80 AMGB 39	RS 80 ABGB 39
10 - 3/8	-	RS 100 AMGB 39	RS 100 ABGB 39
12.5 - 1/2	-	RS 125 AMGB 39	RS 125 ABGB 39
A: 57 mm - 2-1/4"			
8 - 5/16	RS 80 AM 57	RS 80 AMGB 57	-
10 - 3/8	RS 100 AM 57	RS 100 AMGB 57	-
12.5 - 1/2	RS 125 AM 57	RS 125 AMGB 57	-

Length supplied: 8' 2-1/2" — 2.50 m

Accessories	Item No.
Outside corner, 90°	E 90 profile item number*
Outside corner, 135°	E 135 profile item number*
Inside corner, 90°	I 90 profile item number*
Inside corner, 135°	I 135 profile item number*

Outside Corner



Inside Corner

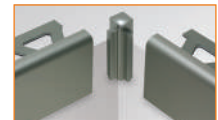

How to order corners:

*To complete the item number for corners, add the corresponding **profile item number** (e.g., E 90 **RS 80 ACGB 39**).

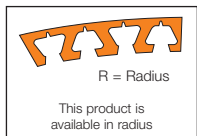
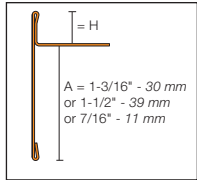
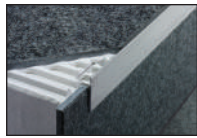

2.8 Schluter®-SCHIENE-STEP

H = mm - in.	Item No.				
	Brushed Stainless Steel 304 (1.4301 = V2A) (EB)				
	Profile	Inside corner, 90°	Inside corner, 135°	Outside corner, 90° and End Cap	Outside corner, 135°
A: 39 mm - 1-1/2"					
6 - 1/4	SS 60 EB 39	I90 / SS 60 EB 39	I135 / SS 60 EB 39	E90 / SS 60 EB 39	E135 / SS 60 EB 39
9 - 11/32	SS 90 EB 39	I90 / SS 90 EB 39	I135 / SS 90 EB 39	E90 / SS 90 EB 39	E135 / SS 90 EB 39
11 - 7/16	SS 110 EB 39	I90 / SS 110 EB 39	I135 / SS 110 EB 39	E90 / SS 110 EB 39	E135 / SS 110 EB 39
12.5 - 1/2	SS 125 EB 39	I90 / SS 125 EB 39	I135 / SS 125 EB 39	E90 / SS 125 EB 39	E135 / SS 125 EB 39
A: 30 mm - 1-3/16"					
9 - 11/32	SS 90 EB 30	-	-	E90 / SS 90 EB 30	-
11 - 7/16	SS 110 EB 30	-	-	E90 / SS 110 EB 30	-
12.5 - 1/2	SS 125 EB 30	-	-	E90 / SS 125 EB 30	-
A: 11 mm - 7/16"					
6 - 1/4	SS 60 EB 11				
12.5 - 1/2	SS 125 EB 11				

H = mm - in.	Item No.	
	Brushed Stainless Steel 304 (1.4301 = V2A) (EB)	
	Connector	
A: 39 mm - 1-1/2"		
6 - 1/4	V / SS 60 EB 39	
9 - 11/32	V / SS 90 EB 39	
11 - 7/16	V / SS 110 EB 39	
12.5 - 1/2	V / SS 125 EB 39	
A: 30 mm - 1-3/16"		
9 - 11/32	V / SS 90 EB 30	
11 - 7/16	V / SS 110 EB 30	
12.5 - 1/2	V / SS 125 EB 30	
A: 11 mm - 7/16"		
6 - 1/4	V / SS 60 EB 11	
12.5 - 1/2	V / SS 125 EB 11	

Length supplied: 8' 2-1/2" — 2.50 m

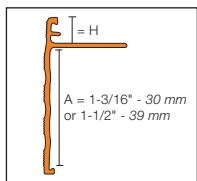

2.8 Schluter®-SCHIENE-STEP

H = mm - in.	Item No.	
	Satin anodized aluminum (AE)	Satin nickel anodized aluminum (AT)
	A: 30 mm - 1-3/16"	
8 - 5/16	SS 80 AE 30	SS 80 AT 30
10 - 3/8	SS 100 AE 30	SS 100 AT 30
12.5 - 1/2	SS 125 AE 30	SS 125 AT 30
15 - 9/16	SS 150 AE 30	SS 150 AT 30
A: 39 mm - 1-1/2"		
8 - 5/16	SS 80 AE 39	SS 80 AT 39
10 - 3/8	SS 100 AE 39	SS 100 AT 39
12.5 - 1/2	SS 125 AE 39	SS 125 AT 39
15 - 9/16	SS 150 AE 39	SS 150 AT 39

Length supplied: 8' 2-1/2" — 2.50 m



Stainless steel

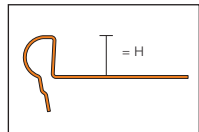

Anodized aluminum

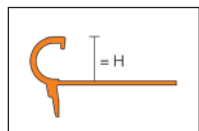

3.4 Schluter®-TREP-FL

H = mm - in.	Item No.		
	Stainless steel 304 (1.4301 = V2A) (E)	Brushed stainless steel 304 (1.4301 = V2A) (EB)	Satin anodized aluminum (AE)
Length supplied: 8' 2-1/2" — 2.5 m			
9 - 11/32	FL 90 E	FL 90 EB	FL 90 AE
11 - 7/16	FL 110 E	FL 110 EB	FL 110 AE
12.5 - 1/2	FL 125 E	FL 125 EB	FL 125 AE
Length supplied: 4' 11" — 1.5 m			
9 - 11/32	FL 90 E/150	FL 90 EB/150	FL 90 AE/150
11 - 7/16	FL 110 E/150	FL 110 EB/150	FL 110 AE/150
12.5 - 1/2	FL 125 E/150	FL 125 EB/150	FL 125 AE/150

Accessories

Accessories	Item No.
End cap	E/ FLEB
End cap	E/ FLAE



End cap

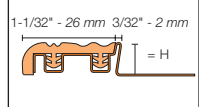

Note: Radius of leading edge = 5/16" - 8 mm.

3.2 Schluter®-TREP-SE

H = mm - in.	Item No.	
	Stainless steel support with thermoplastic rubber insert	Stainless steel support section 304 (1.4301 = V2A)
Length supplied: 8' 2-1/2" — 2.5 m		
8 - 5/16	color* 8 SE	TES 8
10 - 3/8	color* 10 SE	TES 10
12.5 - 1/2	color* 12 SE	TES 12
Length supplied: 4' 11" — 1.5 m		
8 - 5/16	color* 8 SE/150	TES 8/150
10 - 3/8	color* 10 SE/150	TES 10/150
12.5 - 1/2	color* 12 SE/150	TES 12/150

Accessories	Item No.
End cap	E 26/ color*



End cap

Accessories

Item No.
Replacement thermoplastic rubber insert
Length supplied: 8' 2-1/2" — 2.5 m
PE 26/ color*
Length supplied: 9' 10" — 3 m
PE 26/ color* /300

*Color Codes



* To complete the item number, add the **color** code (e.g., **G** 10 SE).

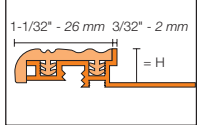

Note: Radius of leading edge = 5/16" - 8 mm.

3.2 Schluter®-TREP-S

H = mm - in.	Item No.	
	Aluminum support with thermoplastic rubber insert	Aluminum support section
Length supplied: 8' 2-1/2" - 2.5 m		
8 - 5/16	color* 8 S	TAS 8
10 - 3/8	color* 10 S	TAS 10
12.5 - 1/2	color* 12 S	TAS 12
Length supplied: 4' 11" - 1.5 m		
8 - 5/16	color* 8 S/150	TAS 8/150
10 - 3/8	color* 10 S/150	TAS 10/150
12.5 - 1/2	color* 12 S/150	TAS 12/150

Accessories	Item No.
End cap	E 26/ color*



Replacement thermoplastic rubber insert

Item No.
Replacement thermoplastic rubber insert
Length supplied: 8' 2-1/2" - 2.5 m
PEA 26/ color*
Length supplied: 9' 10' - 3 m
PEA 26/ color* /300
Length supplied: 50' - 15 m
PEA 26/ color* /50

*Color Codes

 CG Yellow	 G Grey	 HB Light beige	 NB Nut brown
 GS Black			

* To complete the item number, add the **color** code (e.g., **G** 10 S).

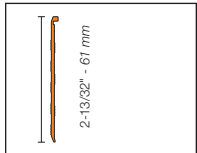
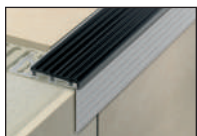

3.2 Schluter®-TREP-TAP

Item No.
Satin anodized aluminum (AE)
2" - 50 mm
Length supplied: 8' 2-1/2" - 2.5 m
TAP 50 AE
Length supplied: 4' 11" - 1.5 m
TAP 50 AE/150
Length supplied: 3' 3" - 1.00 m
TAP 50 AE/100
2-13/32" - 61 mm
Length supplied: 8' 2-1/2" - 2.5 m
TAPR 61 AE
Length supplied: 4' 11" - 1.5 m
TAPR 61 AE/150

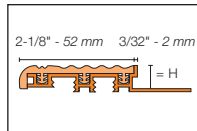

Note: Radius of leading edge = 5/16" - 8 mm.

3.2 Schluter®-TREP-B

H = mm - in.	Item No.	
	Aluminum support with thermoplastic rubber insert	Aluminum support section
Length supplied: 8' 2-1/2" - 2.5 m		
8 - 5/16	color* 8 B	TAB 8
10 - 3/8	color* 10 B	TAB 10
12.5 - 1/2	color* 12 B	TAB 12
15 - 9/16	color* 15 B	TAB 15
25 - 1	color* 25 B	TAB 25
Length supplied: 4' 11" - 1.5 m		
8 - 5/16	color* 8 B/150	TAB 8/150
10 - 3/8	color* 10 B/150	TAB 10/150
12.5 - 1/2	color* 12 B/150	TAB 12/150
15 - 9/16	color* 15 B/150	TAB 15/150
25 - 1	color* 25 B/150	TAB 25/150

Accessories	Item No.
End cap	E 52/ color*



Replacement thermoplastic rubber insert

Item No.
Length supplied: 8' 2-1/2" - 2.5 m
PEA 52/ color*
Length supplied: 10' - 3 m
PEA 52/ color* /300
Length supplied: 50' - 15 m
PEA 52/ color* /50

*Color Codes



* To complete the item number, add the **color** code (e.g., **G** 10 B).

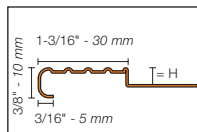

3.3 Schluter®-TREP-E

H = mm - in.	Item No.	
	Stainless steel 304 (1.4301 = V2A)	
Length supplied: 8' 2-1/2" - 2.5 m		
2 - 3/32	TE 20	
5 - 3/16	TE 50	
8 - 5/16	TE 80	
11 - 7/16	TE 110	
16 - 5/8	TE 160	
25 - 1	TE 250	
Length supplied: 4' 11" - 1.5 m		
2 - 3/32	TE 20/150	
5 - 3/16	TE 50/150	
8 - 5/16	TE 80/150	
11 - 7/16	TE 110/150	
16 - 5/8	TE 160/150	
25 - 1	TE 250/150	

Accessories	Item No.
End cap	E/TE



Note: Sizes 80, 110, and 160 are also available in stainless steel 316L (1.4404 = V4A). Contact Customer Service for pricing and availability.

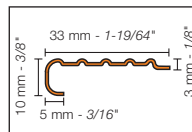

3.3 Schluter®-TREP-EK

Item No.
Stainless steel 304 (1.4301 = V2A)
Length supplied: 8' 2-1/2" - 2.5 m
TEK
Length supplied: 4' 11" - 1.5 m
TEK/150

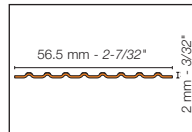

3.3 Schluter®-TREP-EFK

Item No.
Stainless steel 316L (1.4404 = V4A) (E)
Length supplied: 8' 2-1/2" - 2.5 m
TEF56K/V4A

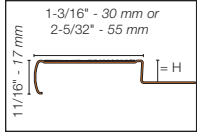

3.3 Schluter®-TREP-G-S

H = mm - in.	Item No.
	Brushed stainless steel support with non-slip tread (30 mm - 1-3/16")

Length supplied: 8' 2-1/2" — 2.5 m	
9 - 11/32	GS EB 90 <i>color*</i>
11 - 7/16	GS EB 110 <i>color*</i>
13 - 33/64	GS EB 130 <i>color*</i>
15 - 9/16	GS EB 150 <i>color*</i>

Length supplied: 4' 11" — 1.5 m	
9 - 11/32	GS EB 90 <i>color*</i> / 150
11 - 7/16	GS EB 110 <i>color*</i> / 150
13 - 33/64	GS EB 130 <i>color*</i> / 150
15 - 9/16	GS EB 150 <i>color*</i> / 150

3.3 Schluter®-TREP-G-B

H = mm - in.	Item No.
	Brushed Stainless steel support with non-slip tread (55 mm - 2-5/32")

Length supplied: 8' 2-1/2" — 2.5 m	
9 - 11/32	GB EB 90 <i>color*</i>
11 - 7/16	GB EB 110 <i>color*</i>
13 - 33/64	GB EB 130 <i>color*</i>
15 - 9/16	GB EB 150 <i>color*</i>

Length supplied: 4' 11" — 1.5 m	
9 - 11/32	GB EB 90 <i>color*</i> /150
11 - 7/16	GB EB 110 <i>color*</i> /150
13 - 33/64	GB EB 130 <i>color*</i> /150
15 - 9/16	GB EB 150 <i>color*</i> /150

3.3 Schluter®-TREP-GK-S

Item No.
Brushed stainless steel support with non-slip tread (34 mm - 1-11/32")

Length supplied: 8' 2-1/2" — 2.5 m	
GS EBK <i>color*</i>	
Length supplied: 4' 11" — 1.5 m	
GS EBK <i>color*</i> /150	

3.3 Schluter®-TREP-GK-B

Item No.
Brushed stainless steel support with non-slip tread (59 mm - 2-21/64")

Length supplied: 8' 2-1/2" — 2.5 m	
GB EBK <i>color*</i>	
Length supplied: 4' 11" — 1.5 m	
GB EBK <i>color*</i> /150	

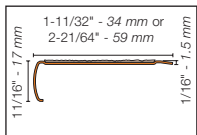

Item No.

Replacement tread
Length supplied: 60' 1-1/32" — 18.3 m
GS KB 183/ <i>color*</i>

Accessories	Item No.
End cap	E/GS EB



***Color Codes**

 GS Black
  T Transparent

To complete the item number, add the *color** code (e.g., GS EB 90 **GS**).



Item No.

Replacement tread
Length supplied: 60' 1-1/32" — 18.3 m
GB KB 183/ <i>color*</i>

Accessories	Item No.
End cap	E/GB EB



***Color Codes**

 GS Black
  T Transparent

To complete the item number, add the *color** code (e.g., GS EB 90 **GS**).

Schluter®-Systems Stair-Nosing Profiles 5-Year Limited Warranty

LIMITED WARRANTY COVERAGE: Subject to the conditions and limitations as stated in this **Schluter®-Systems Stair-Nosing Profiles 5-Year Limited Warranty** (the “**Limited Warranty**”), Schluter-Systems warrants that its Schluter®-RONDEC-STEP, Schluter®-TREP-SE, Schluter®-TREP-S, Schluter®-TREP-B, Schluter®-SCHIENE-STEP, Schluter®-TREP-E, Schluter®-TREP-EK, Schluter®-TREP-FL, Schluter®-TREP-TAP, Schluter®-TREP-EFK and Schluter®-TREP-G, Schluter®-TREP-GK (collectively, the “**Products**”) will be free from manufacturing defects and will perform as described in the Schluter-Systems Stair-Nosing Profiles Technical Data Sheet (collectively, the “**Written Materials**”) for a period of five (5) years from the date of purchase when installed and used in accordance with the terms and conditions of the Written Materials and industry standard guidelines that are not in conflict with the Written Materials in effect at the time of installation.

For the purposes of this Limited Warranty, “**Owner**” is defined as the original end user of the property in which the Products are installed; and “**Tile Assembly**” is defined to include the Products, non-reusable tile surfaces, and applicable setting and grouting materials.

This Limited Warranty is only applicable to installations in the United States of America and Canada. Schluter-Systems is not responsible or liable under any circumstances for determining the suitability of the Products for the Owner's intended purpose. It is the responsibility of the Owner to consult with an experienced and professional installer to ensure the suitability of the Products, subfloor/substrate and all building materials in the installation and that the Written Materials are followed properly.

RESOLUTION: If the Products are installed and used in accordance with the terms and conditions as described hereinabove and such Products are proven defective within the applicable warranty term, the Owner's exclusive remedy and the sole obligation of Schluter-Systems, at its election, shall be to (a) reinstall or replace the failed portion of the Tile Assembly or (b) pay an amount not to exceed the original square foot cost of the installation of the Tile Assembly verified to be defective. Due to conditions beyond the control of Schluter-Systems (e.g., color and shade availability, discontinuation, normal wear and tear), Schluter-Systems cannot guarantee or warrant an exact match to the specific tile, stone, or other flooring materials used in the original installation. In such event, substantially similar materials may be substituted.

EXCLUSIONS FROM COVERAGE: This Limited Warranty excludes and in no event shall Schluter-Systems have any liability for any indirect, special, incidental, punitive, exemplary, or consequential damages, including lost profits, arising out of or otherwise connected to the failure of the Products or Tile Assembly, regardless of any strict liability or active or passive negligence of Schluter-Systems, and regardless of legal theory, whether in contract, tort, extra-contractual or other. This Limited Warranty further excludes any loss or damage arising out of or otherwise connected to: acts of war, terrorism, fire, explosion, natural disaster, acts of God, any failure to comply with the Written Materials, inadequate subfloor/substrate, improper preparation or other failure of subfloor/substrate, faulty or negligent penetration of the Products or subfloor/substrate, intentional acts of destruction, structural failure, misuse of or failure to maintain the Products, normal wear and tear, scratches, dents, corrosion or discoloration (whether caused by excessive heat, chemical cleaning products, abrasive agents or otherwise), efflorescence and shading which are a natural occurrence with cementitious materials and are not considered a defective condition for the purposes of this Limited Warranty, variations of texture, color or shade from those on product samples, packaging materials or other marketing materials, or other causes unrelated to the Products (e.g. floor covering failure, excess point loading, overvoltage). This Limited Warranty excludes exterior applications and applications utilizing glass tile or other non-approved floor coverings, unless specifically approved in writing on a case by case basis by the Schluter-Systems Technical Services Director.

This Limited Warranty is conditioned and will be considered null and void and Schluter-Systems will have the right to refuse any claims if: (a) the Products have been improperly stored or installed, or (b) the Products are subject to abusive or abnormal use, lack of maintenance, or used in a manner other than that for which the Products were designed or in any way contrary to the Written Materials.

DISCLAIMER: There are no warranties beyond this expressed warranty as stated herein. To the extent permitted by law, all other warranties, representations or conditions, expressed or implied, are hereby disclaimed and excluded, including but not limited to the implied warranties of **MERCHANTABILITY** or **FITNESS FOR A PARTICULAR PURPOSE** (as limited to such purposes as described in the Written Materials) or arising from a course of dealing, usage of trade or otherwise by law. ANY IMPLIED WARRANTIES ARISING BY OPERATION OF LAW ARE LIMITED IN DURATION TO THE TERM OF THIS LIMITED WARRANTY. NO REPRESENTATION, PROMISE, AFFIRMATION OR STATEMENT BY ANY EMPLOYEE OR AGENT OF SCHLUTER-SYSTEMS WILL BE ENFORCEABLE AGAINST SCHLUTER-SYSTEMS UNLESS IT IS SPECIFICALLY INCLUDED IN THIS LIMITED WARRANTY OR AUTHORIZED IN WRITING BY THE SCHLUTER-SYSTEMS TECHNICAL SERVICES DIRECTOR. This Limited Warranty is given in lieu of any other warranty, whether expressed or implied. The remedies contained herein are the only remedies available for breach of this Limited Warranty. This Limited Warranty extends only to the Owner and is not transferable or assignable unless authorized by written agreement and signed by the Schluter-Systems Technical Services Director or otherwise prohibited by specific state or provincial law. This Limited Warranty gives you specific legal rights; some states and provinces do not allow disclaimers or other restrictions of implied warranties; some of the above disclaimers may not apply to you. No changes or modifications of any terms or conditions of this Limited Warranty are permitted unless duly authorized in writing by the Schluter-Systems Technical Services Director. This Limited Warranty shall supersede and replace any and all prior oral or written warranties, agreements, or other representations made by or on behalf of Schluter-Systems relative to the Products or the application of the Products and shall apply to any installation occurring on or after April 8, 2019. If the Products are used in conjunction with other Schluter products, a different Schluter warranty may apply. For the most current information and materials regarding Schluter-Systems warranties and programs, please visit https://www.schluter.com/schluter-us/en_US/downloadfiles.

MAKING A CLAIM: To make a claim under this Limited Warranty, the Owner must provide Schluter-Systems² with written notice within thirty (30) days of any alleged defect in the Products covered by this Limited Warranty, together with date and proof of purchase of such Products and/or all of its components and name and address of all installers and all invoices related to the original installation, failing which this Limited Warranty shall have no legal effect³. Schluter-Systems reserves the right at its election and as a condition of this Limited Warranty to inspect the alleged failed and/or defective Products.

All U.S. Claims shall be sent to:

Schluter Systems L.P.
Attn: Warranty Claims Dept.
194 Pleasant Ridge Road
Plattsburgh, NY 12901-5841

All Canadian Claims shall be sent to:

Schluter Systems (Canada), Inc.
Attn: Warranty Claims Dept.
21100 chemin Ste-Marie
Ste-Anne-de-Bellevue, QC H9X 3Y8

¹ If there are any conflicting terms between any Written Materials, the most recently updated document shall be deemed to control.

² This Limited Warranty is limited to sales of the Products made in and intended for use in the United States and Canada. For the purposes of this Limited Warranty, Schluter Systems L.P. shall offer warranty coverage to Owners located in the United States, and Schluter Systems (Canada) Inc. shall offer warranty coverage to Owners located in Canada.

³ In the event that Owner fails to provide such required invoices relating to the original installation, Schluter-Systems shall pay Owner an amount equal to the average, reasonable costs of a comparable installation. If the parties fail to agree on such amount, such dispute shall promptly, and in the first instance, be submitted: (a) if a U.S. claim, to arbitration in Clinton County, New York, in accordance with the rules of the American Arbitration Association, or (b) if a Canadian claim, in the Province of Quebec, Canada, in accordance with the ADRIC Arbitration Rules. Any outcome of such arbitration proceeding shall be final and binding upon the parties hereto.



Schluter Systems L.P. • 194 Pleasant Ridge Road, Plattsburgh, NY 12901-5841 • Tel.: 800-472-4588 • Fax: 800-477-9783
Schluter Systems (Canada) Inc. • 21100 chemin Ste-Marie, Ste-Anne-de-Bellevue, QC H9X 3Y8 • Tel.: 800-667-8746 • Fax: 877-667-2410

www.schluter.com

This technical data sheet is subject to change without notice. Please visit www.schluter.com for the latest version.