

Home Decorators

— Collection —

BF-22673 HAMPTON BAY COLLECTION BATH 4 DOORS 1 DRAWER TALL CABINET

ASSEMBLY INSTRUCTIONS



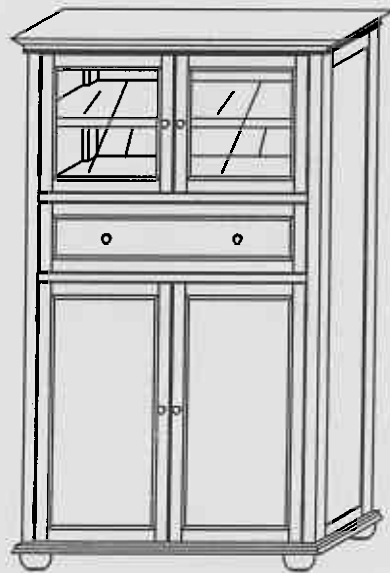





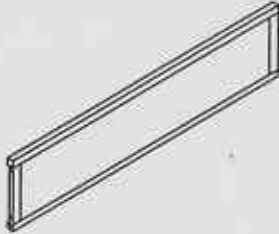
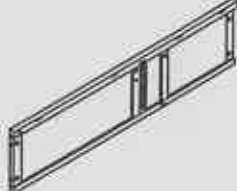

Made In China

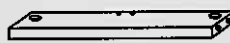

Thank you for purchasing this quality product. Be sure to check all packing material carefully for small parts, which may have come loose inside the carton during shipment. Count all parts and material hardware, Compare with parts list to be sure all part are present. If any parts are missing or damaged, phone, fax, or mail to our Customer Service Department. For efficient and speedy service please indicate the model number and code letter of part(s) need

IMPORTANT NOTE: Follow instructions listed below in proper sequence as numbered to assure fast, easy and correct assembly.

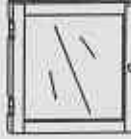
PARTS LIST

<p style="text-align: center;">A</p>  <p style="text-align: center;">TOP PANEL-1PC</p>	<p style="text-align: center;">B</p>  <p style="text-align: center;">RIGHT SIDE PANEL-1PC</p>	<p style="text-align: center;">C</p>  <p style="text-align: center;">LEFT SIDE PANEL-1PC</p>
<p style="text-align: center;">D</p>  <p style="text-align: center;">BOTTOM PANEL-1PC</p>	<p style="text-align: center;">E</p>  <p style="text-align: center;">ACROSS PANEL-1PC</p>	<p style="text-align: center;">F</p>  <p style="text-align: center;">ACROSS PANEL-1PC</p>
<p style="text-align: center;">G</p>  <p style="text-align: center;">BACK PANEL-2PCS</p>	<p style="text-align: center;">H</p>  <p style="text-align: center;">FEETS-4PCS</p>	<p style="text-align: center;">I</p>  <p style="text-align: center;">SHELF-3PCS</p>
<p style="text-align: center;">J</p>  <p style="text-align: center;">UP LEFT DOOR-1PC</p>	<p style="text-align: center;">K</p>  <p style="text-align: center;">UP RIGHT DOOR-1PC</p>	<p style="text-align: center;">L</p>  <p style="text-align: center;">DOWN LEFT DOOR-1PC</p>

M



DOWN RIGHT DOOR-1PC

N



DRAWER PANEL FRONT-1PC

O



LEFT
DRAWER PANEL SIDE-1PC

P



RIGHT
DRAWER PANEL SIDE-1PC

Q



DRAWER PANEL BACK-1PC

R



DRAWER PANEL BOTTOM-1PC

S



CAM-LOCKS-14PCS

T



CAM-BOLTS-14PCS

U

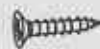

SCREWS-11PCS

V



SCREWS-6PCS

W



KNOB-6PCS

X



SHELF SUPPORTS-12PCS

Y



LARGE MAGNETS-2PCS

Z



HINGE-8PCS

A1



SCREWS-52PCS

B1



FEMALE MAGNETS-4PCS

C1



DOWELS-2PCS

D1



SCREWS-30PCS

E1



CAM-TOOL-1PC

F1



REAR PANEL GUIDE-1PC

NOTE: • UPON OPENING THOROUGHLY CLEAN ALL WOODS SURFACES TO REMOVE DUST AND DIRT THAT MAY HAVE SETTLED ONTO FINISH DURING SHIPMENT. IN ORDER TO PREVENT DAMAGE DURING ASSEMBLY, PLEASE ASSEMBLE THIS ITEM WITH AT LEAST TWO PEOPLE.

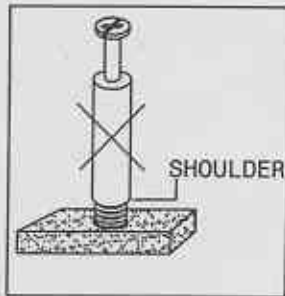
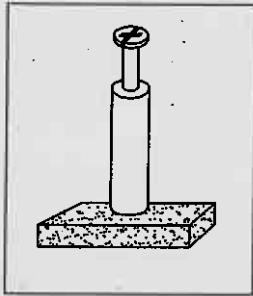

NOTE: TURN THE CAM-BOLT SCREWS UNTIL THEY ARE TIGHT, THE SHOULDER SHOULD BE AGAINST THE SURFACE OF THE PART.

HOW TO USE THE CAM-TOOL

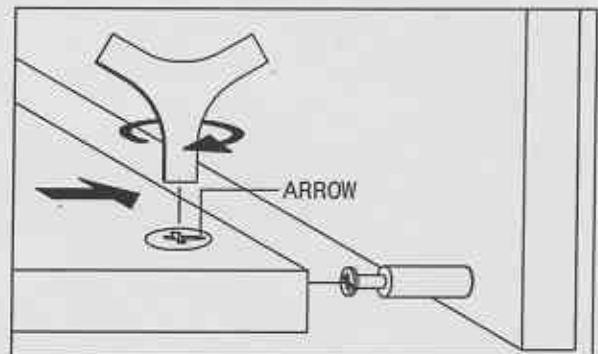
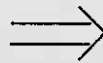
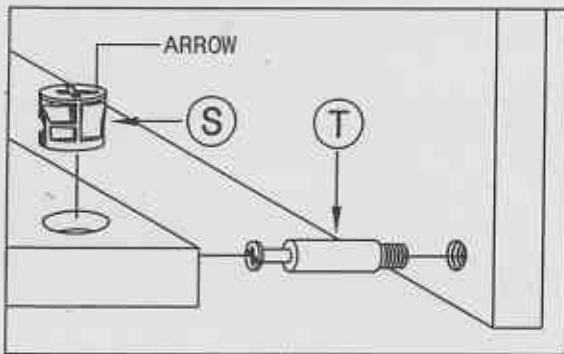

NOTE: • THE ARROWS ON THE HIDDEN CAM-LOCKS SHOULD POINT TO THE CAM-BOLTS

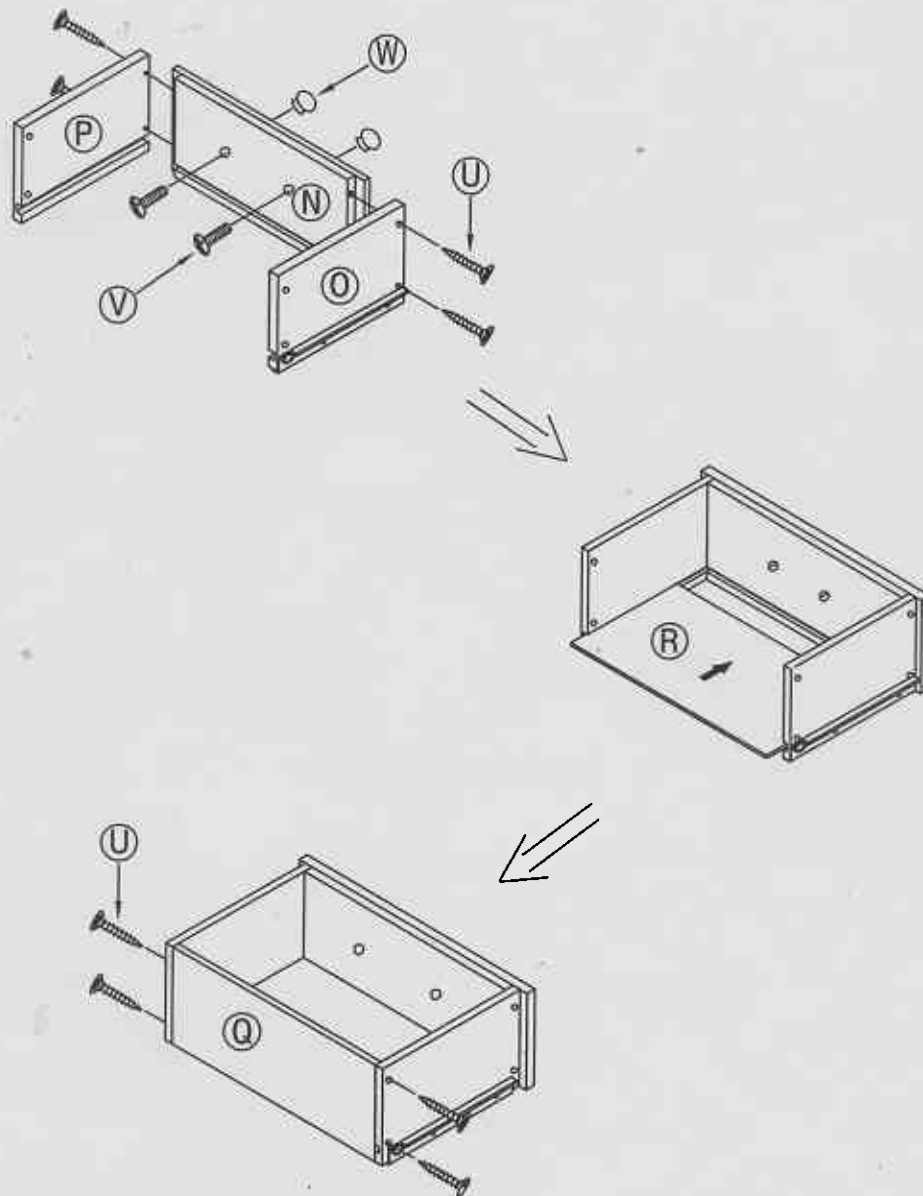

1). ASSEMBLE THE DRAWER.

- ATTACH SIDE PANEL(O/P)TO DRAWER FRONT PANEL(N)USING SCREWS(U).
- ATTACH THE KNOB(W)TO DRAWER FRONT PANEL(N)USING SCREWS(V).
- INSERT THE DRAWER BOTTOM PANEL(R)INTO SLOTS IN DRAWER SIDE PANEL(O/P).
- ATTACH BACK PANEL(Q)TO BETWEEN SIDE DRAWER PANEL(O/P)USING SCREWS(U).

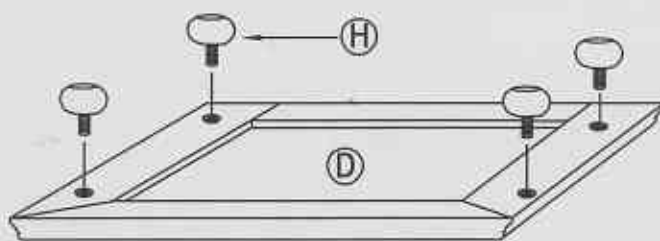

2) . ASSEMBLE THE FEET (H) .

- ROTATE THE 4 FEET (H) INTO HOLES IN BOTTOM PANEL (D) .

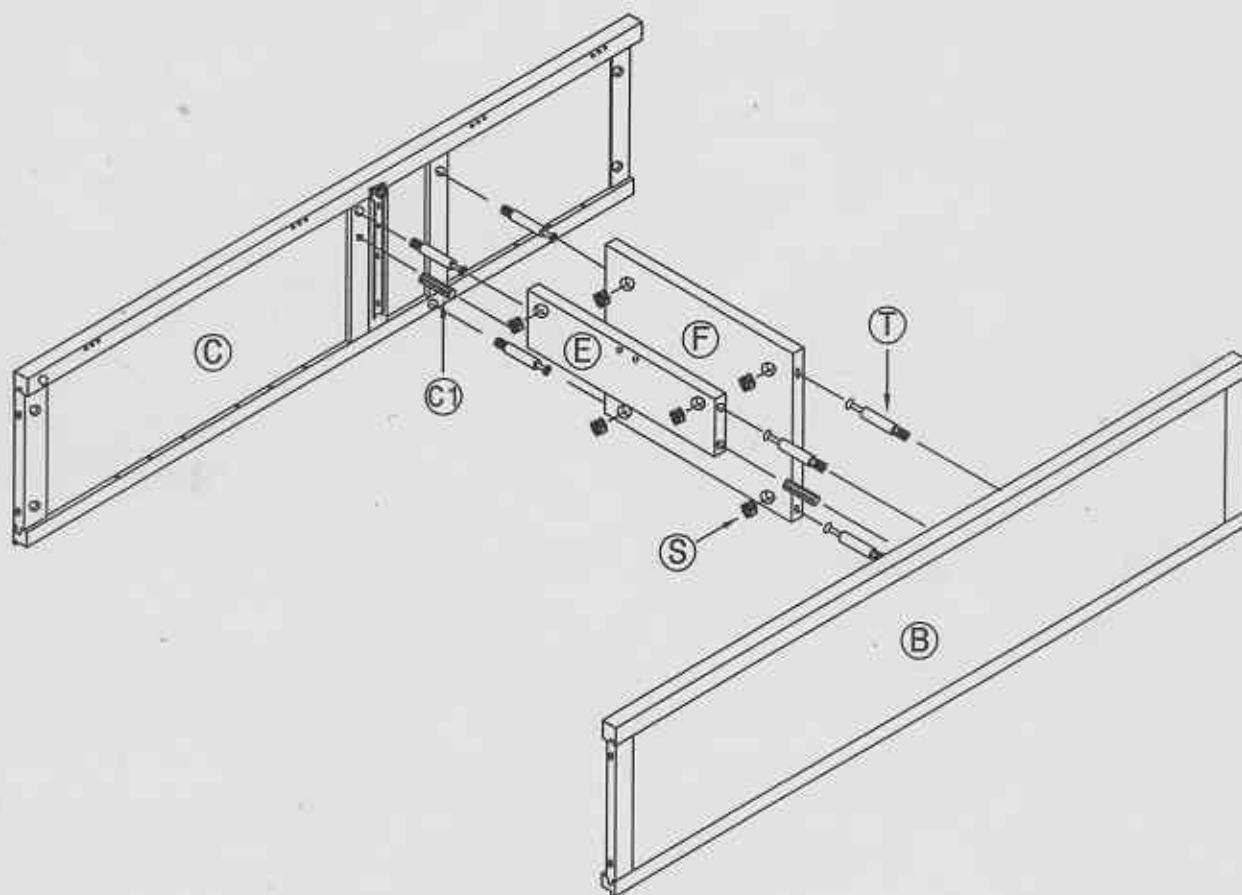

3) . ASSEMBLE THE SIDE PANEL (B/C) .

- INSERT THE 2 DOWELS (C1) INTO HOLES IN ACROSS PANEL (E) .
- ROTATE THE 6 CAM-BOLTS (T) INTO HOLES INTO SIDE PANEL (B/C) .
- PLACE THE CAM-BOLTS (T) INTO HOLES IN PANEL (E/F) AND ATTACH USING 6 CAM-LOCKS (S) .

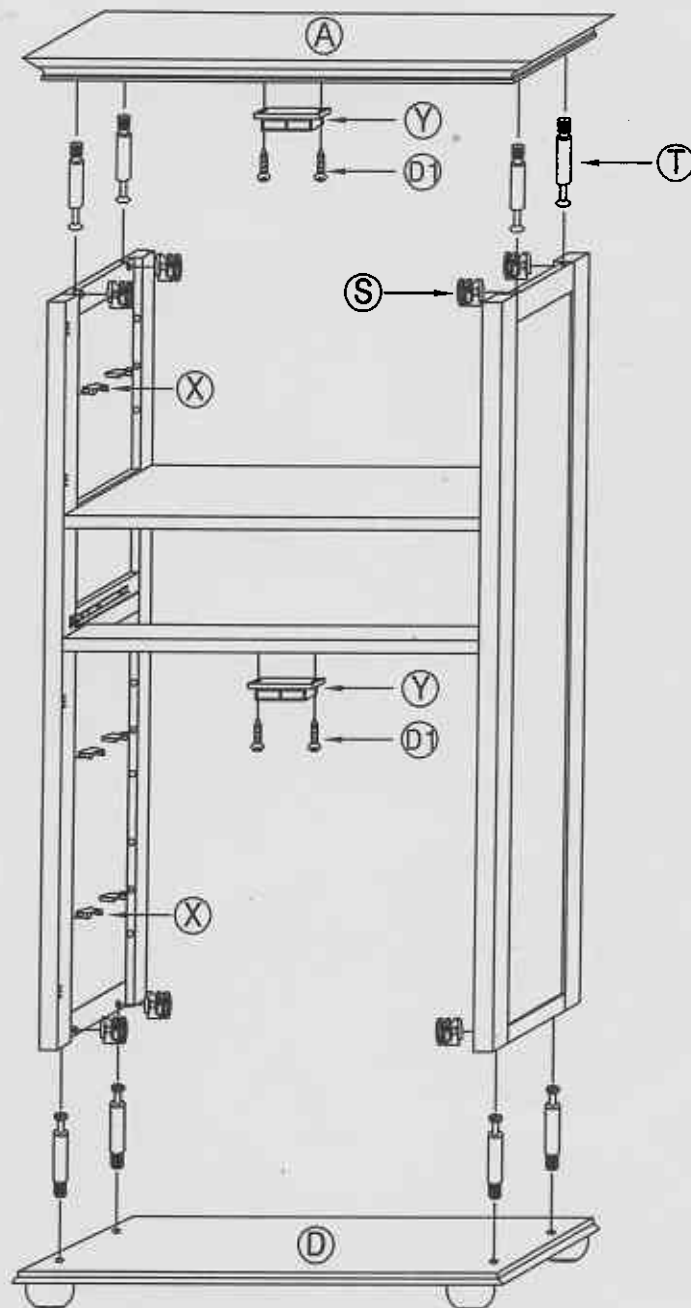

4) . ASSEMBLE THE TOP/BOTTOM PANEL(A/D) .

- ROTATE THE 8 CAM-BOLTS(T) INTO HOLES INTO TOP/BOTTOM PANEL(A/D) .
- PLACE THE CAM-BOLTS(T) INTO HOLES IN PANEL(B/C) AND ATTACH USING 8 CAM-LOCKS(S) .
- INSERT THE 12 SHELF SUPPORTS(X) INTO HOLES IN SIDE PANEL(B/C) .
- ATTACH 2 LARGE MAGNETS(Y) TO TOP/ACROSS PANEL(A/E) USING 4 SCREWS(D1) .

NOTE: (Attach right doors(K/M)by the same method as left doors(J/L) with hinges(Z)and screws(A1).

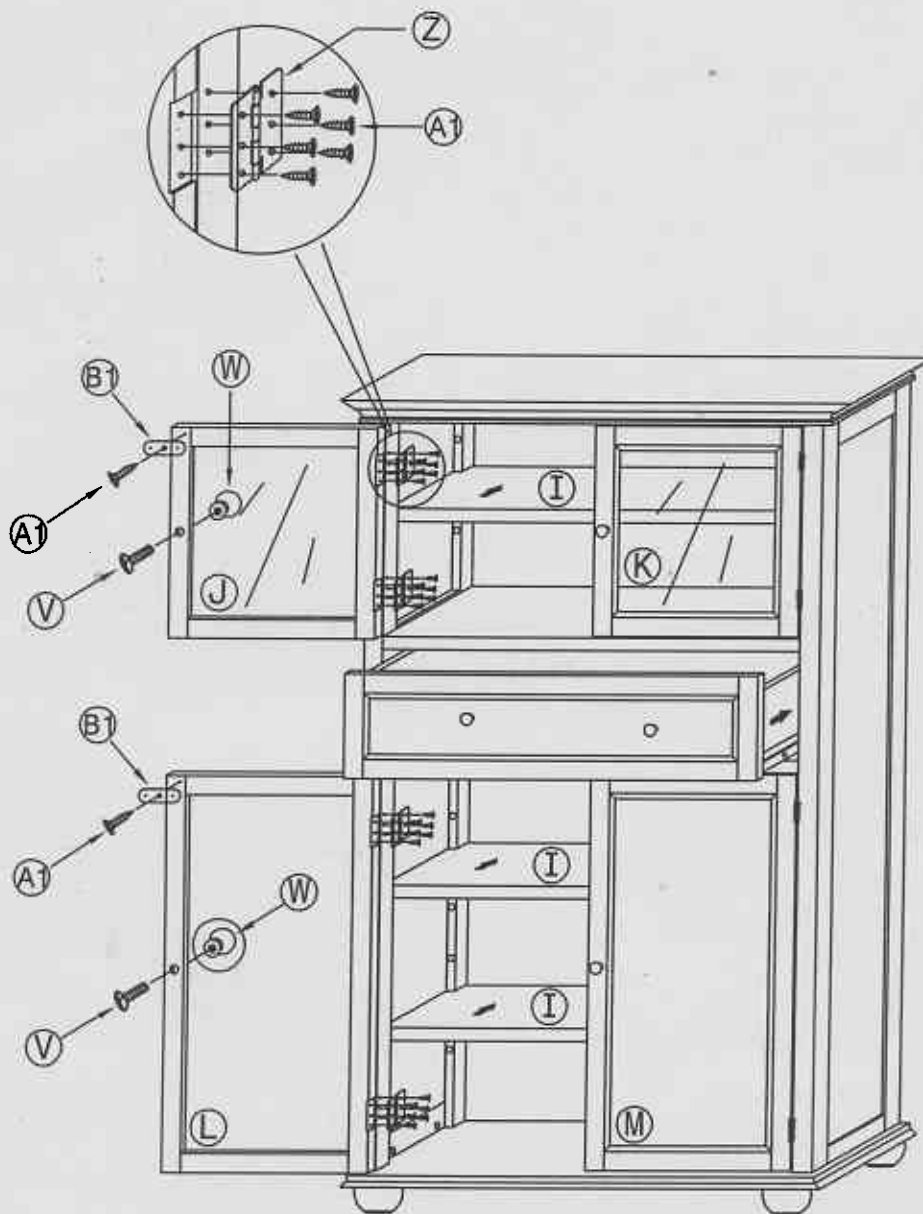

5) . ASSEMBLE THE DOORS(J/K/L/M) .

- ATTACH 4 HINGES(Z) TO LEFT DOORS(J/L) AND LEFT SIDE PANEL(C) USING 24 SCREWS(A1) .
- ATTACH 2 KNOB(W) TO LEFT DOORS(J/L) USING 2 SCREWS(V) .
- ATTACH 2 FEMALE MAGNETS(B1) TO LEFT DOORS(J/L) USING 2 SCREWS(A1) .
- SLIDE DRAWER INTO SIDE SLIDERS .
- FINALLY, PUT THE 3 SHELF(I) ONTO THE SHELF SUPPORTS(X) .

Note: Before you assemble the back panel, please make sure the doors have an even gap around them. If uneven, shift the unit LEFT OR RIGHT UNTIL the doors are evenly spaced, then attach back panel.

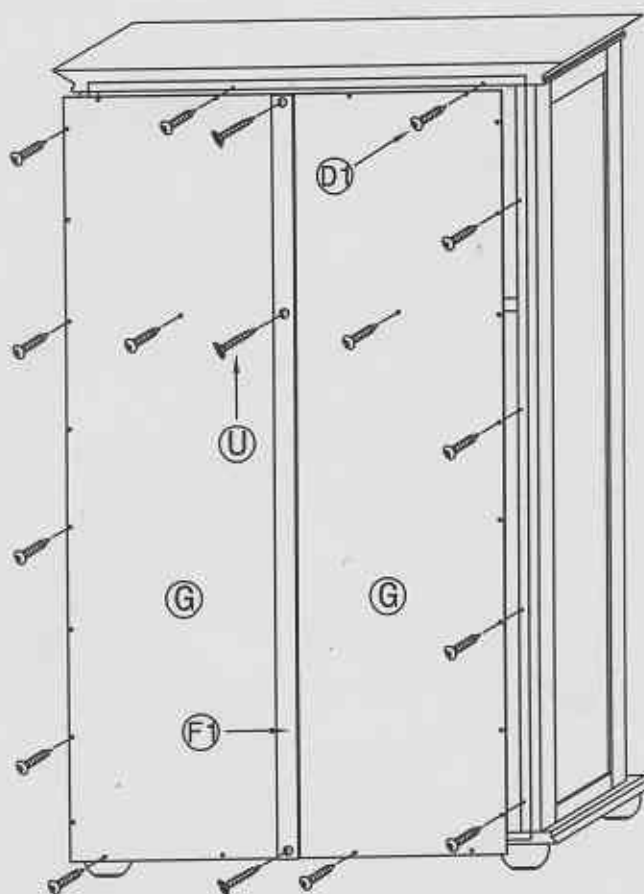

6) . ASSEMBLE THE BACK(G) .

- INSERT THE BACK PANEL (G) INTO SLOT IN REAR PANEL GUIDE (F1) .
- ATTACH THE BACK PANEL (G) AND REAR PANEL GUIDE (F1) USING SCREWS (D1/U) .