

Assembly Instructions

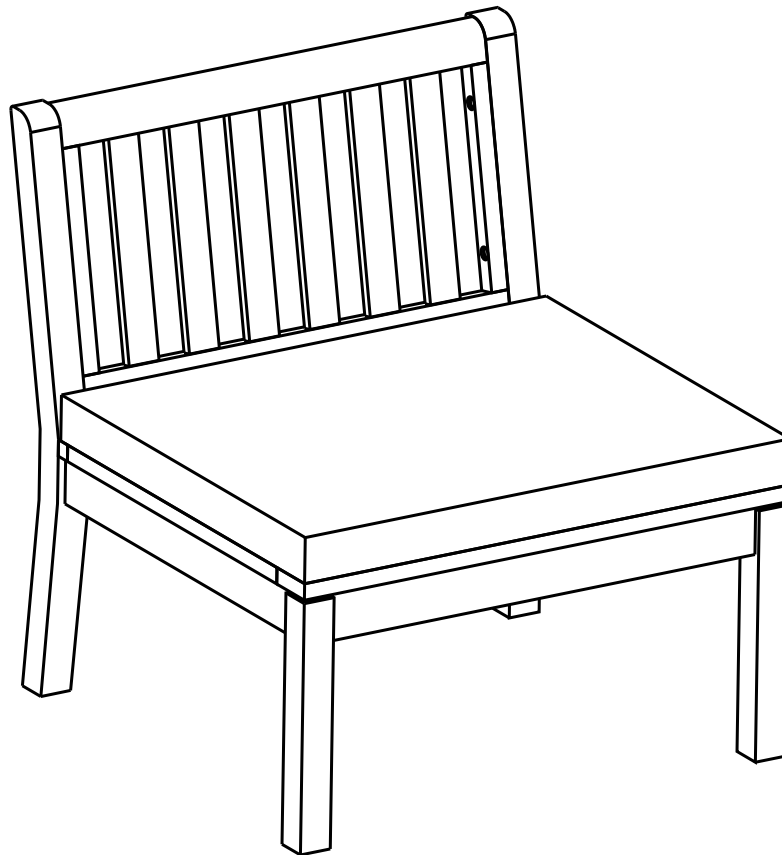



Caution: You must read this before you proceed

Please look underneath the seat panel for hardware packs



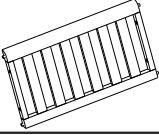
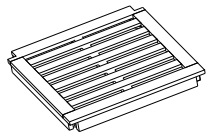

Chair

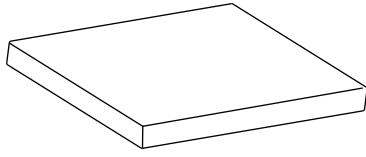

Parts List

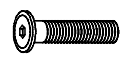
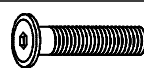
| Label | Picture | Description | QTY |
|-------|---|----------------|-----|
| A |  | Backrest Panel | 1 |
| B |  | Seat Panel | 1 |
| C |  | Short Leg | 2 |
| D |  | Long Right Leg | 1 |
| E |  | Long Left Leg | 1 |
| F |  | Seat Cushion | 1 |

Hardware

| Label | Picture | Description | QTY |
|-------|---|-------------------------------|-----|
| ① |  | Bolt (M6x40 mm) | 5 |
| ② |  | Bolt (M6x60 mm) | 9 |
| ③ |  | Spring Washer (6.5/11x2mm) | 9 |
| ④ |  | Washer (6.5/16x2mm) | 9 |
| ⑤ |  | Allen Key | 1 |

Assembly Preparation

Before Beginning Assembly:

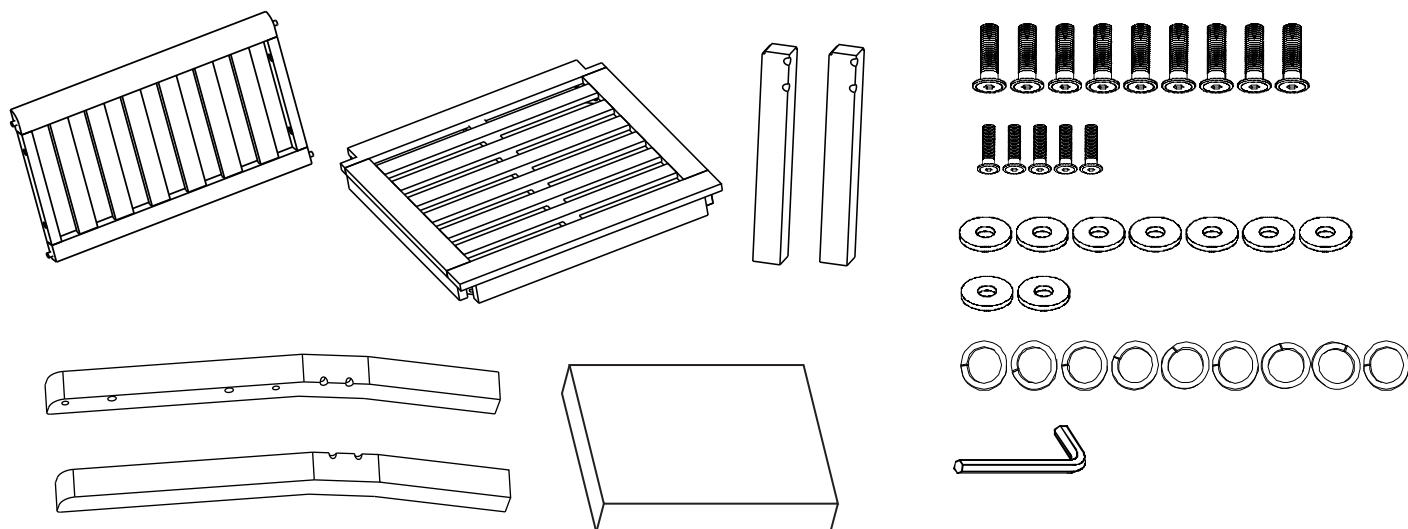

• Read instructions, cover to cover-



• Have 2 adults on hand for assembly-



• Do not assemble on flooring or carpet-



• Assemble on a clean non-marring surface (packing foam)-



• Save all packaging until finished

Assembly Steps

OVERVIEW

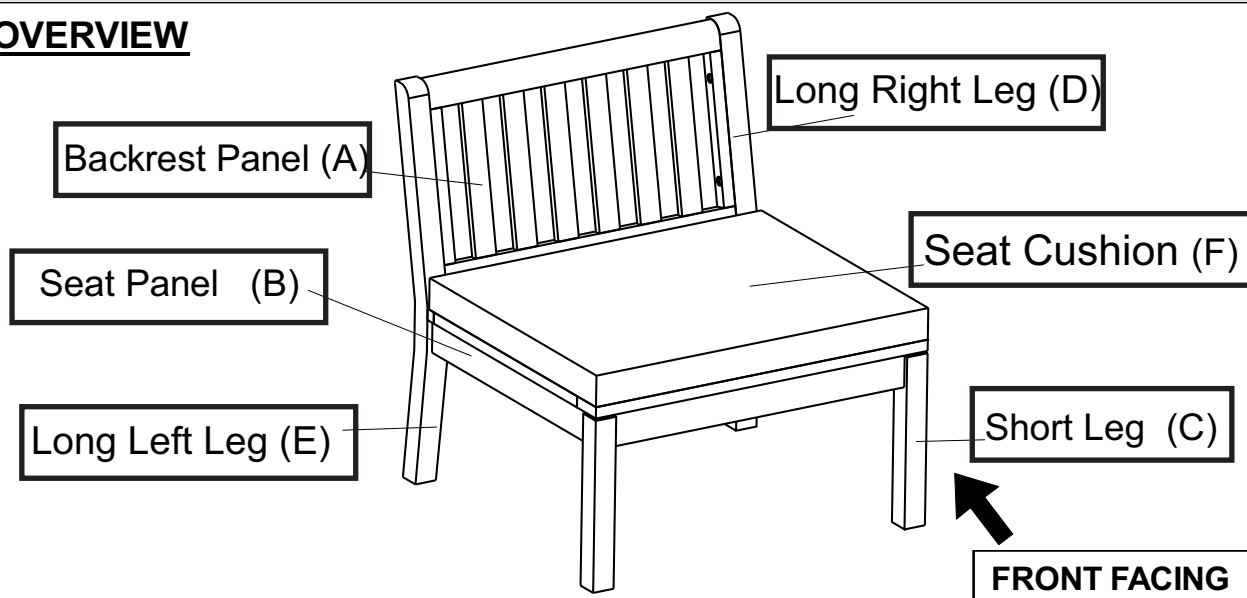

This Chair has multiple parts and may require up to 30 minutes to assemble. To give you an overview of the Chair parts, the above picture is to help you put the various parts into perspective. Please read through the instructions below to familiarise yourself with the parts and steps before assembly.

Step 1

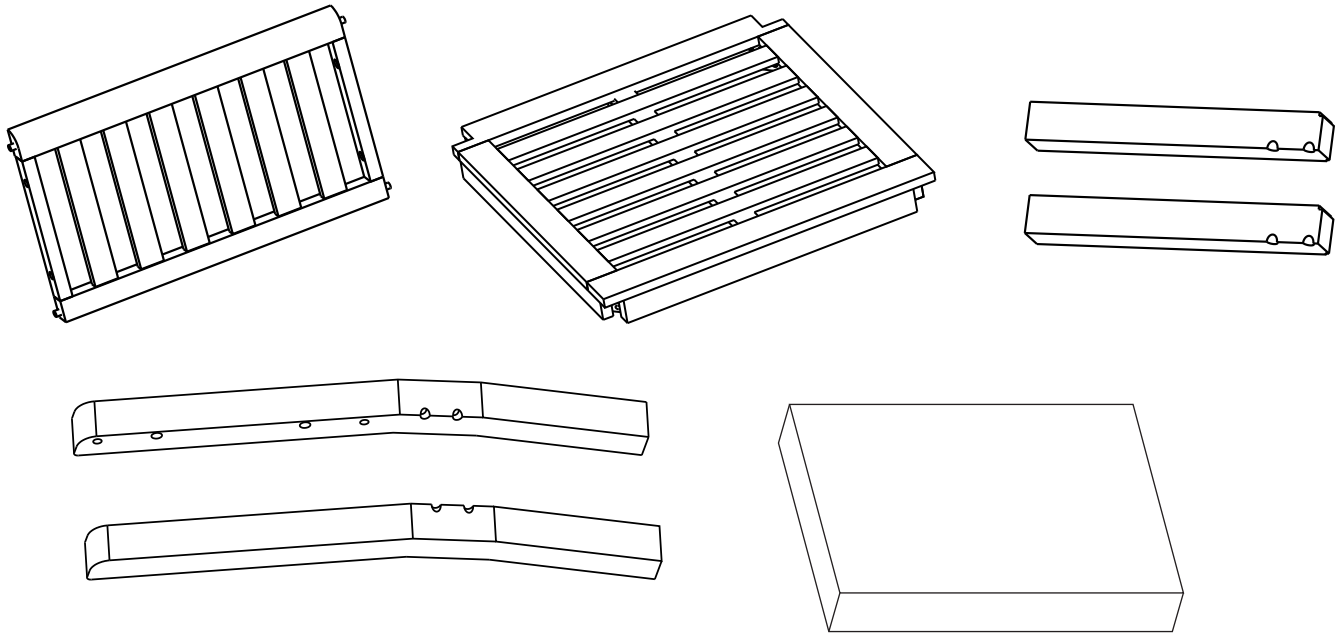

Unpack and place all parts on a clean, non-marring surface.

Step 2

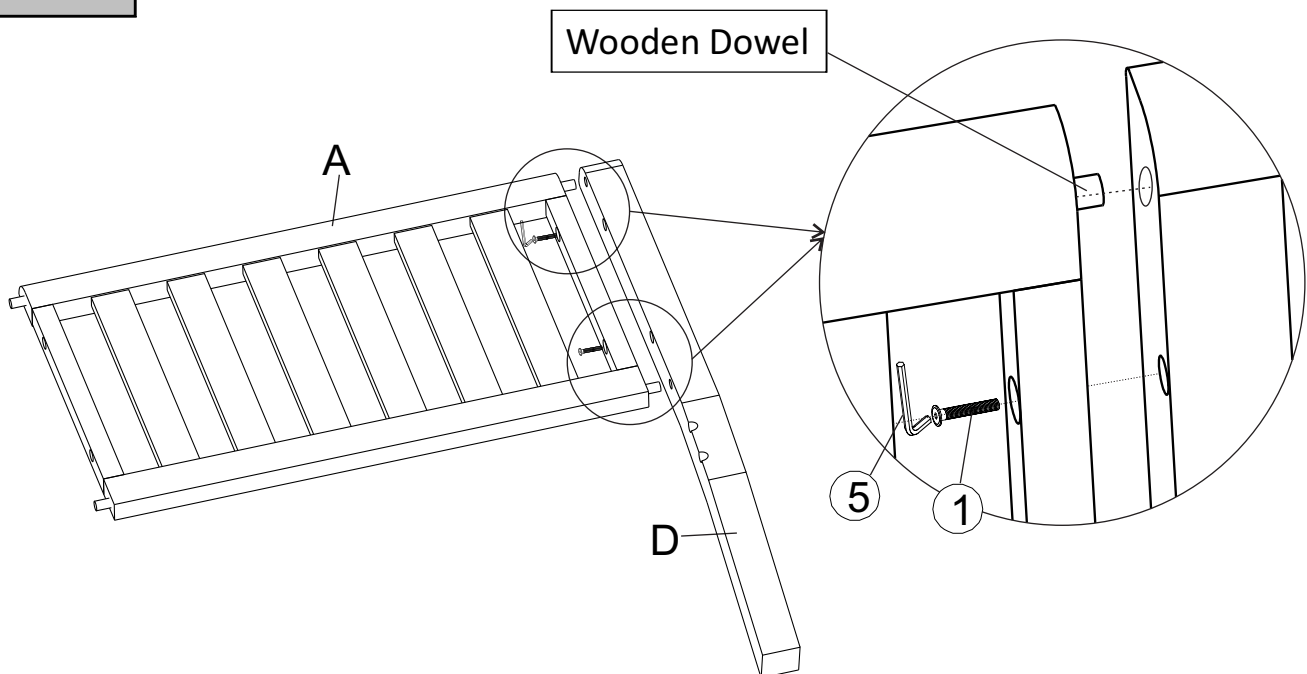

With assistance from your adult partner, insert Wooden Dowel on Backrest Panel(A) into the mortise of Long Right Leg(D). Attach Long Right Leg(D) to Backrest Panel(A) using Bolts(①) with Allen Key(⑤).

Do not fully tighten the Bolts.

Repeat the same process with the remaining Long Left Leg(E).

Step 3

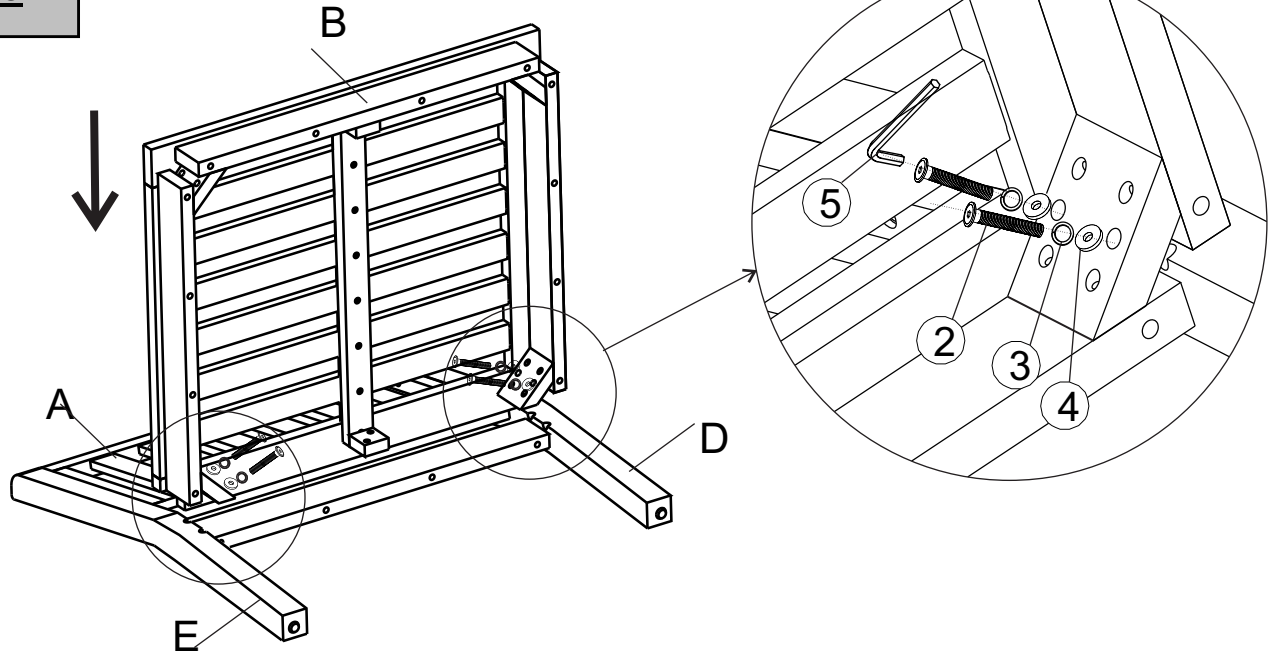

With assistance from your adult partner, put Seat Panel(B) onto Backrest Panel(A) with Long Right Leg(D) and Long Left Leg(E) in the direction of the arrow as shown in above picture.

Attach Seat Panel(B) to Long Right Leg(D) and Long Left Leg(E) using Bolts(②), Spring Washers(③), and Washers(④) with Allen Key(⑤).

Do not fully tighten the Bolts.

Step 4

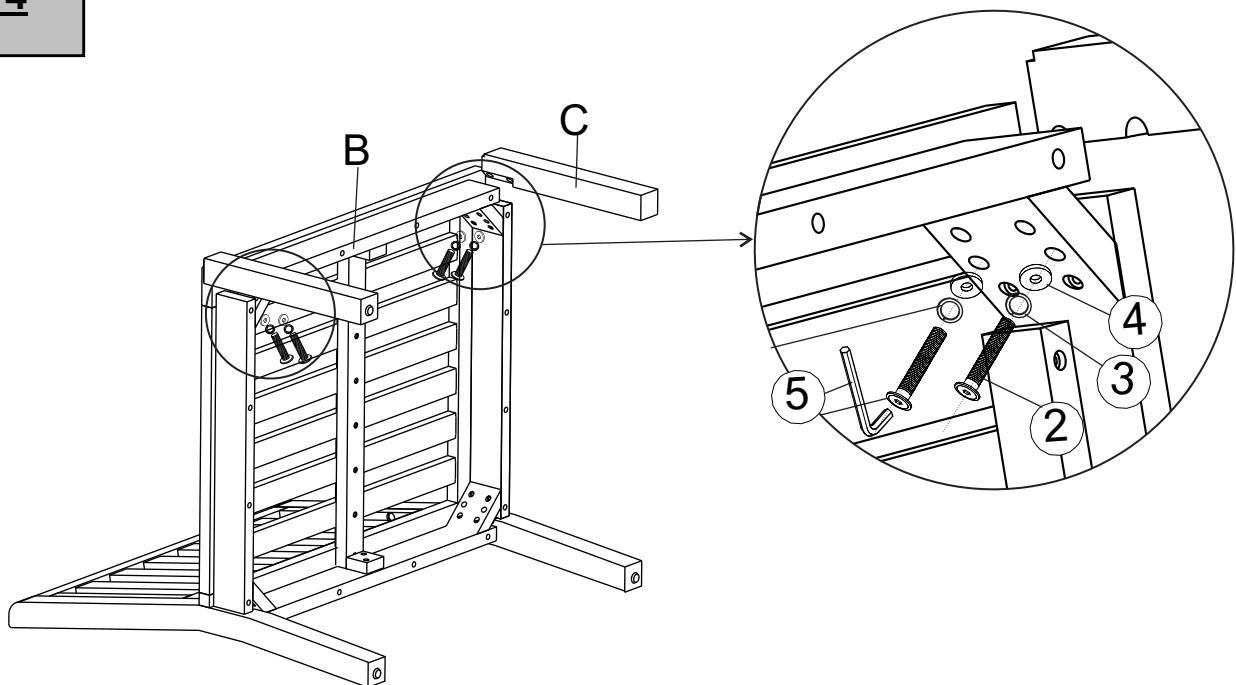

Attach Short Legs (C) to Seat Panel(B) using Bolts(②), Spring Washers(③), and Washer(④) with Allen Key(⑤).

Do not fully tighten the Bolts.

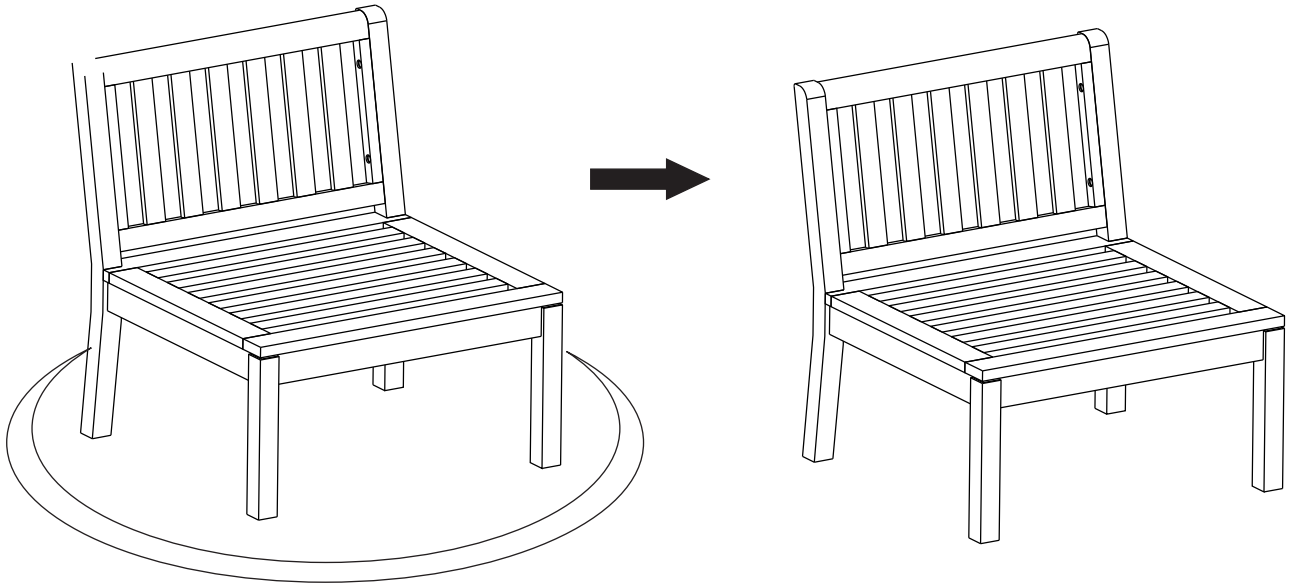

Stand the Chair up, with assistance from your adult partner.
Exert pressure floorwards, onto the Chair with both your hands.
This pressure will help the Legs and Chair reach full alignment status.
Check for wobbles on a LEVEL surface.
If no wobbles are found proceed to tighten the Bolts in a sequential manner, until evenly secured.

When tightening the Bolts tighten sequentially.

**Do not tighten any Bolt fully and then move on towards the next one.
If there are still wobbles, loosen the Bolts and execute the same above process.**

If the Chair is not Stable it could lead to damage to the product.



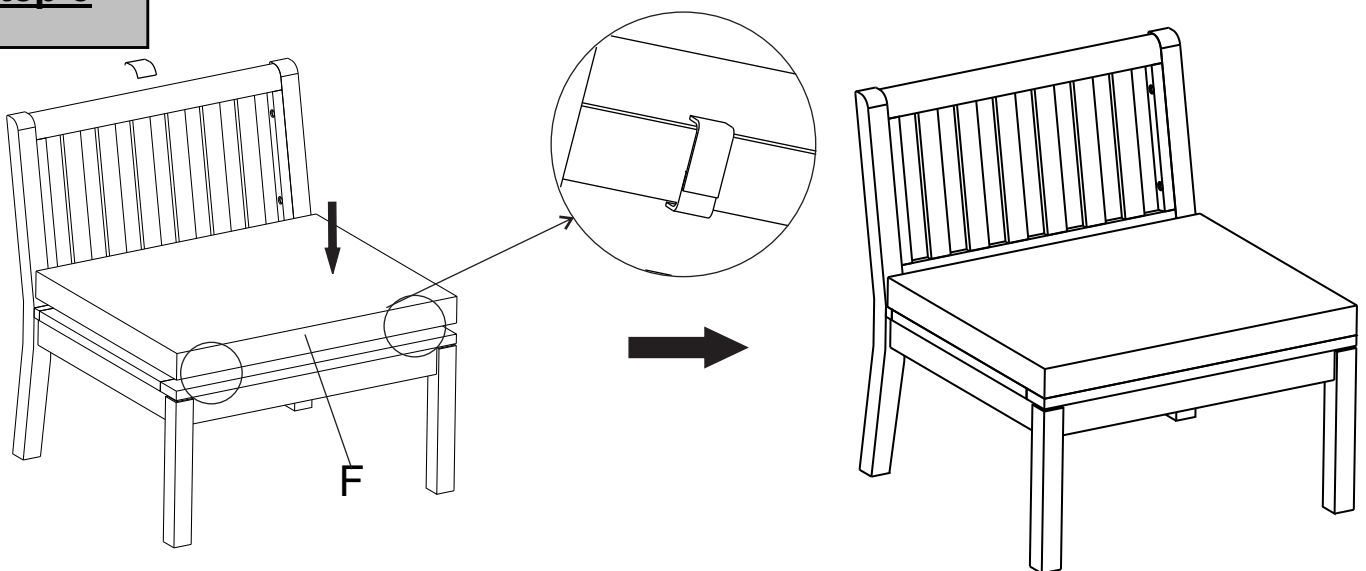













Step 5





Put Seat Cushion(F) onto the Chair.
Tie the velcro straps of Seat Cushion(F) to the slats of Seat Panel(B).
Your Chair is ready for use.

This Chair can only be used on a flat, level surface.

Care & Maintenance

-   ● Do not put hot items directly on furniture surface
-   ● Do not clean furniture with harsh cleansers or polish.
-   ● To obtain the longest lifespan of your outdoor products, minimizing exposure to direct sunlight is recommended.
-   ● Children should not climb or jump on the furniture.
-   ● Do not write on furniture without a padded barrier to protect the surface.
-   ● To obtain the longest lifespan of your outdoor products, avoid extended and lengthy exposure to rain, snow, and direct sunshine. Whenever possible cover the product and /or place under patio or awnings.
-   ● Not for commercial use. For residential use only .
-   ● Stains may be removed with mild soap solution and damp cloth.

-   ● Dust and pick-up spills using a clean, non-colored, lint-free cloth .