



KIDS JUMPER TRAMPOLINE

MODEL# 9001KJ
PRODUCT MANUAL - VERSION 2.19.1

FOR AGES:

3-7

WEIGHT LIMIT:

75 Lbs
34 Kgs

TO BUILD:



TOOLS NEEDED:



HOW-TO
VIDEOS ONLINE



Manual en
español ubicado
en GQBrands.com

Spanish Manual located
at GQBrands.com

CUSTOMER SERVICE

GQBrands.com • CustomerService@GQBrands.com • 1-866-498-5269 • 4401 Samuell Blvd, Ste 150, Mesquite, TX 75149



CUSTOMER SERVICE INFORMATION

Thank you for purchasing: KIDS JUMPER TRAMPOLINE

MODEL# 9001KJ

If you have an issue with your item, do not return. Please report items that are damaged or missing parts to the manufacturer GQ Brands within three days of delivery. Contact customer service at customerservice@gqbrands.com or toll-free at 1-866-498-5269

At GQBrands®, we want all of our customers to be completely satisfied with their purchase. Take time to review the contents of the product you have just received to make sure that all of the parts are included. If you find that any parts are missing or damaged, we will provide replacement parts at no charge within 30 days of purchase.

Please keep in mind that for select damaged part replacement requests, we will require a photo for submission.

To order these parts, or if you have any other questions or concerns about this GQBrands product, please contact us at

PureFun.Net
GQBrands@
Phone: 1-866-498-5269
Email: CustomerService@GQBrands.com
4401 Samuell Blvd, Ste 150,
Mesquite, TX 75149

Please be sure to include the following information when you contact Customer Service:

YOUR NAME: _____

YOUR MAILING ADDRESS: _____

YOUR EMAIL ADDRESS: _____

PRODUCT NAME: _____

PRODUCT MODEL#: _____

PART NUMBER _____

RETAILER WHERE PURCHASED: _____

DATE OF PURCHASE: _____

ORDER NUMBER: (If Available) _____

SERIAL NUMBER: (If Available) _____

QUANTITY NEEDED: _____

PICTURE OF DAMAGED PART

LIMITED WARRANTY

Global Quality Brands® warrants this product to be free from defects in workmanship and materials under normal use and conditions for a period of 90 DAYS FROM THE DATE OF ORIGINAL PURCHASE. This Limited Warranty is not transferable and is available only for the original purchaser of the Product. The Company's obligation under this warranty is limited to replacing or repairing the Product, at the discretion of the company.

All warranty coverage extends only to the original retail purchaser from the date of purchase, GQ Brands obligation under this warranty is limited to replacing or repairing, at Global Quality Brands® option. All products for which a warranty claim is made must be received by Global Quality Brands® and accompanied by sufficient proof of purchase (photocopy of the original store receipt, indicating the date of purchase). All freight and handling fees are the responsibility of the consumer to pay, both to and from Global Quality Brands®. All warranty claims must be preauthorized by Global Quality Brands® pre-authorization can be obtained by calling 866-498-5269.

This warranty does not cover ordinary wear and tear, weathering, failure to follow directions, improper installation, improper maintenance, or acts of nature, (such as damage caused by wind, lightning, snow, water, or ice) weather damage, damage caused by unauthorized repair work or damage caused by improper use of the products are not covered by the product warranty. No other warranty beyond that specifically set forth above is authorized by GQBrands®.

GLOBAL QUALITY BRANDS® IS NOT RESPONSIBLE OR LIABLE FOR INDIRECT, SPECIAL OR CONSEQUENTIAL DAMAGES ARISING OUT OF OR IN CONNECTION WITH THE USE OR PERFORMANCE OF THE PRODUCT OR OTHER DAMAGES WITH RESPECT TO ANY ECONOMIC LOSS, LOSS OF PROPERTY, LOSS OF REVENUE OR PROFITS, LOSS OF ENJOYMENT OR USE, COST OF REMOVAL, INSTALLATION OR OTHER CONSEQUENTIAL DAMAGES. SOME STATES DO NOT ALLOW THE EXCLUSION OR LIMITATION OF INCIDENTAL OR CONSEQUENTIAL DAMAGES. ACCORDINGLY,

THE ABOVE LIMITATION MAY NOT APPLY TO YOU. THE WARRANTY EXTENDED HEREUNDER IS IN LIEU OF ALL OTHER WARRANTIES AND GLOBAL QUALITY BRANDS®, SPECIFICALLY DISCLAIMS ANY IMPLIED WARRANTY OF MERCHANTABILITY OR FITNESS FOR A PARTICULAR PURPOSE IS LIMITED IN ITS SCOPE AND DURATION TO THE TERMS SET FORTH HEREIN. SOME STATES DO NOT ALLOW LIMITATION ON HOW LONG AN IMPLIED WARRANTY LASTS. ACCORDINGLY, THE ABOVE LIMITATION MAY NO APPLY TO YOU. THIS WARRANTY GIVES YOU SPECIFIC LEGAL RIGHTS. YOU MAY ALSO HAVE OTHER RIGHTS, WHICH VARY FROM STATE TO STATE.

WHILE EVERY ATTEMPT IS MADE TO ENSURE THE HIGHEST DEGREE OF PROTECTION IN ALL EQUIPMENT, WE CANNOT GUARANTEE FREEDOM OF INJURY. THE USER ASSUMES ALL RISK OF INJURY DUE TO USE. ALL MERCHANDISE IS SOLD ON THIS CONDITION, WHICH NO REPRESENTATIVE OF GQBRANDS® CAN WAIVE OR CHANGE.



WARNINGS



ADULT ASSEMBLY REQUIRED **CHOKING HAZARD - Small Parts** **NOT** for children under 3 years of age.

Please read these warnings and the information in this manual in its entirety.

Failure to comply with the following instructions may increase the risk of serious injury and/or death:

- This unit must be assembled and disassembled by **ADULTS ONLY**.
- Children must be supervised at all times when using this equipment. **DO NOT** leave children unattended at any time.
- Children **MUST NEVER** use the trampoline unless supervised by a responsible adult with knowledge of trampoline use.
- This trampoline is suitable for use by most children **3 TO 7 YEARS OF AGE**.
- **DO NOT** exceed the **MAXIMUM WEIGHT** limit of 75lbs (34kgs) regardless of age.
- This trampoline is **NOT** for adult use.
- The trampoline handle is only intended to assist your child with controlling their bounce and maintaining their balance on the mat. The handle should **NOT** be used for any other purpose or as a climbing feature.
- This trampoline is only designed for normal residential indoor use. It is **NOT** intended for commercial applications and/or in public areas such as schools, parks, nurseries, day schools, day cares, etc. For **INDOOR USE ONLY**: Your trampoline should be placed at a safe distance from any obstructions, stairways, windows, furniture, appliances, etc.
- **DO NOT** allow more than one person on the trampoline at a time.
- **DO NOT** wear glasses or helmets when using the trampoline.
- **DO NOT** fall or bounce on your knees, this can cause injury.
- **DO NOT** allow other persons to go under, sit, stand or lie on or near the frame pads or mat while the trampoline is in use.
- **ALWAYS** secure this trampoline against unauthorized and/or unsupervised use.
- **DO NOT** use or allow use of the trampoline under the influence of any substance or medication which may impair the supervisor's or jumper's judgment and/or coordination.
- Mount and dismount the trampoline with care as injury may result.
- **ALWAYS** remove jewelry, belt buckles or any other sharp objects before using the trampoline.
- **ALWAYS** jump in the middle of the trampoline bed.
- **ALWAYS** wear socks when using the trampoline.
- **NEVER** wear footwear (e.g. shoes) when using the trampoline.
- Before using this product, inspect and replace any worn, defective or missing parts. Although the pad, foam and mat are made to take a lot of wear, over time these parts may need to be replaced. It is important to check the trampoline periodically to ensure the frame is steady and all parts are in good condition.
- Please read and refer to other warnings and use information in the trampoline instructions before use.
- Dispose of all packaging materials safely and per local ordinance.
- **ALWAYS** supervise your children while they are playing on or around the trampoline.
- The unit is **NEVER** to be used by more than one child at a time. The trampoline is designed so the child can bounce and balance on the mat.
- **NEVER** allow your child to attempt somersaults or flips on this trampoline as it is not designed for such play features.
- The trampoline should **NOT** be used in conjunction with, or attached to any other play equipment.
- Children are **NOT** to stand or sit on the edge of the trampoline.
- **ALWAYS** secure the trampoline when not in use to prevent unauthorized and/or unsupervised use.
- **NEVER** store items, playthings, or allow pets or other children to crawl under the Jump Mat at any time.

ASSEMBLY WARNINGS

- Adult Assembly Required.
- Please read all instructions carefully.
- Please dispose of all packing material carefully and keep it away from children.
- Ensure you have all of the parts listed on the Parts List. If any parts are missing please contact customer service.
- Take a few minutes to familiarize yourself with the contents and instructions before attempting assembly.
- When you are ready to start, make sure that you have the correct tools at hand, and adequate space for assembly.

PARTS LIST

A - Jumping Mat

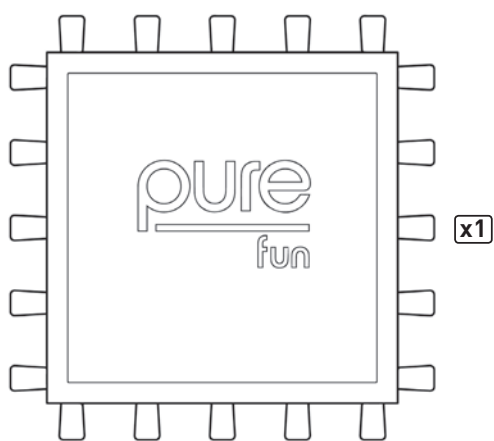

B - Frame Leg with Square Opening

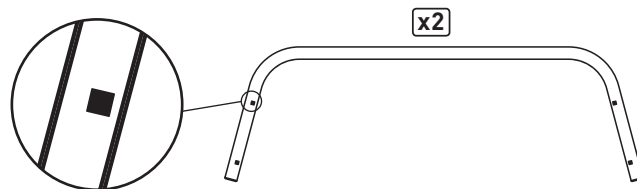

C - Frame Leg with Round Opening

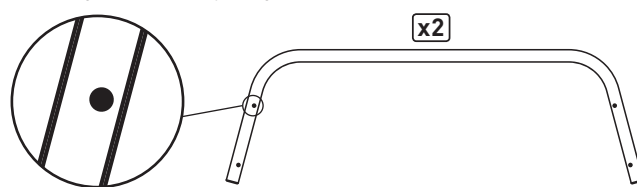

D/F - Handle Arch - Female

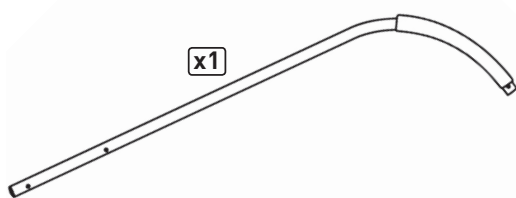

D/M - Handle Arch - Male

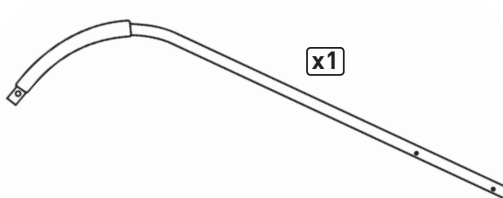

E - Frame Leg Foams

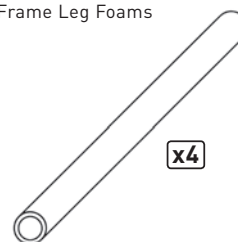

F - Long Bolts



G - Short Bolts



H - Nut



I - Washer



J - Spacer

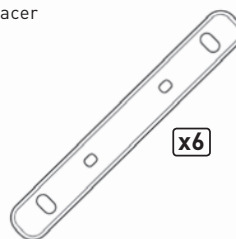

K - Black Cap



ASSEMBLY INSTRUCTIONS

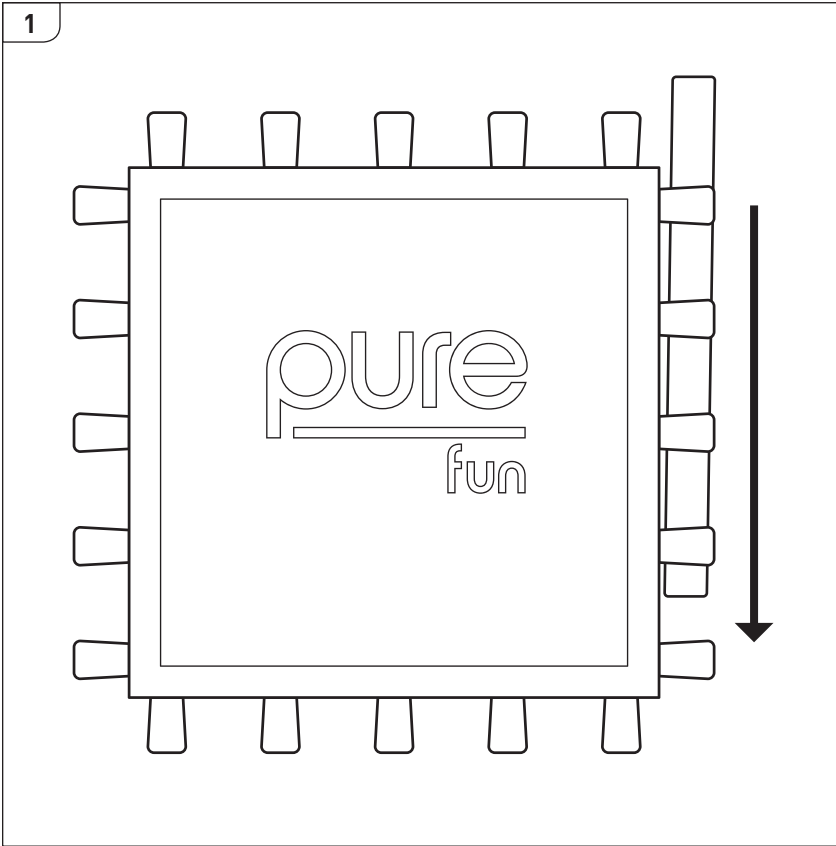

STEP 1:

Find a clean open area to properly set-up the trampoline.

Place the Jumping Mat (Part A) flat on the floor with the logo facing upward. Then insert the Frame Leg Foams (Part E) inside the openings for all 4 sides of the Jumping Mat.

NOTE:

Make sure all foams are properly placed to avoid injury when using product.

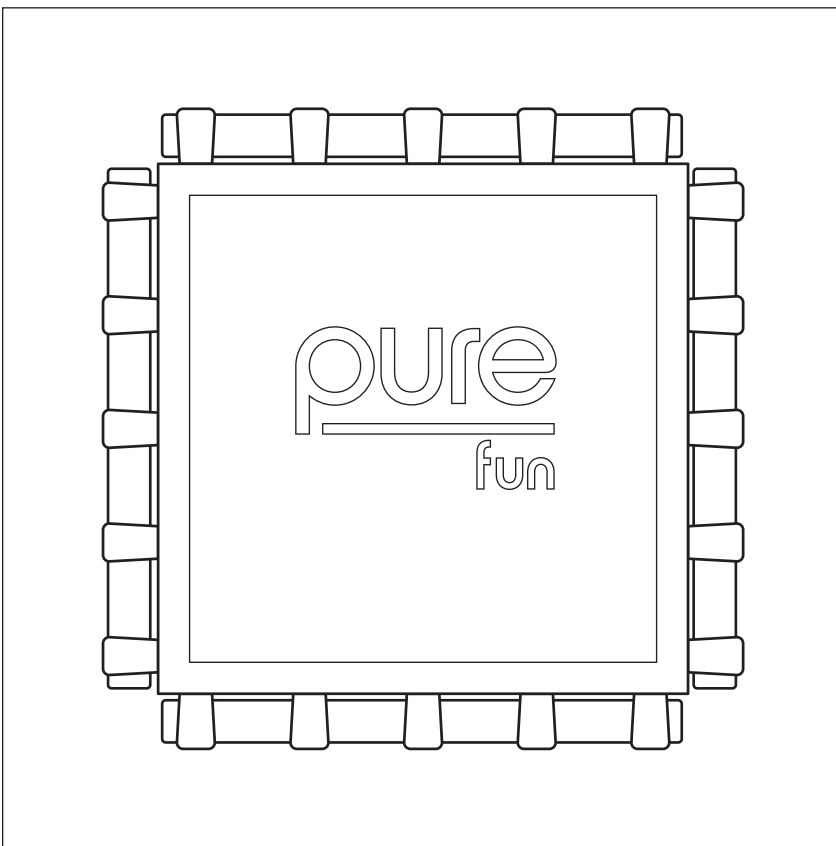

ASSEMBLY INSTRUCTIONS

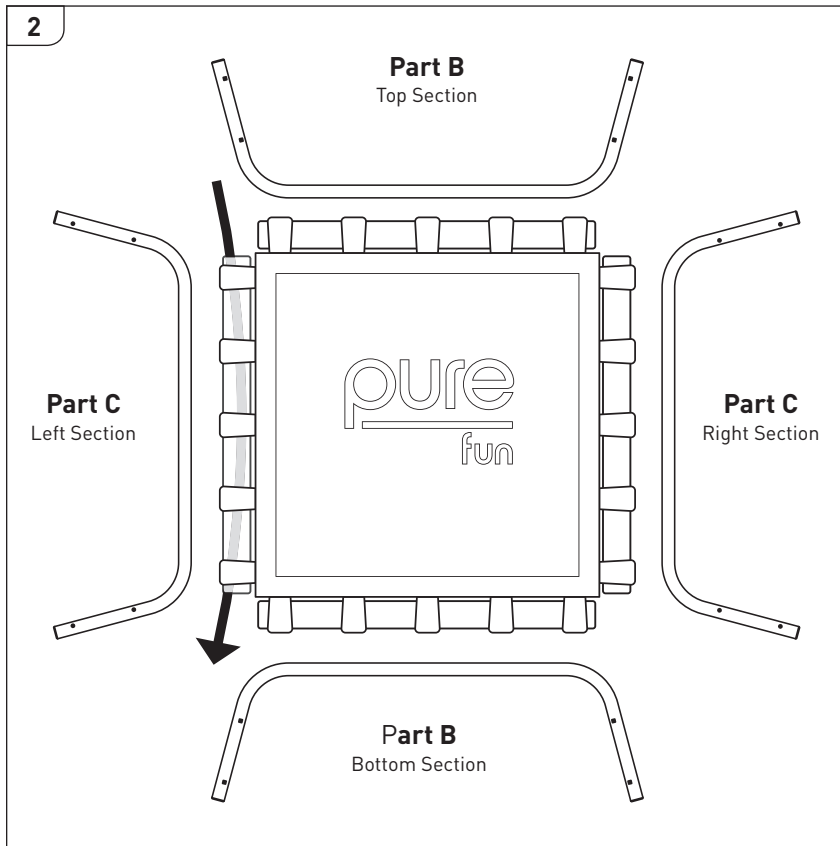

STEP 2:

Insert Frame Legs with Square Openings (Part B) on the Top and Bottom foams of the Jumping Mat. Make sure that openings are facing inwards.

Then insert Frame Legs with Round Openings (Part C) on the left and right foams of the Jumping Mat. Make sure that openings are facing inwards.

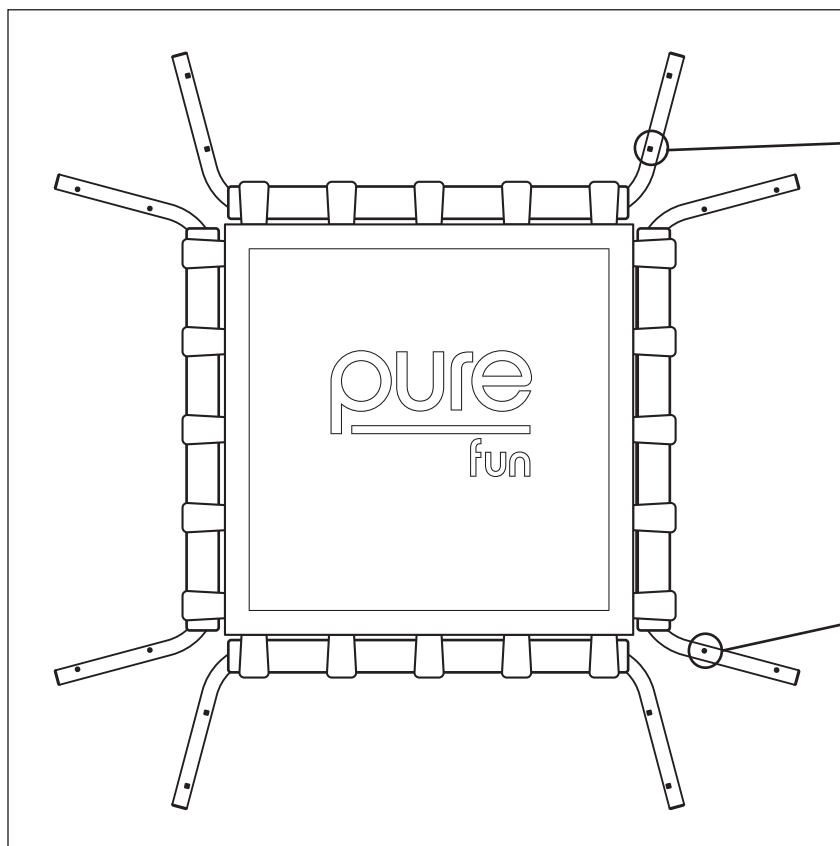

ASSEMBLY INSTRUCTIONS

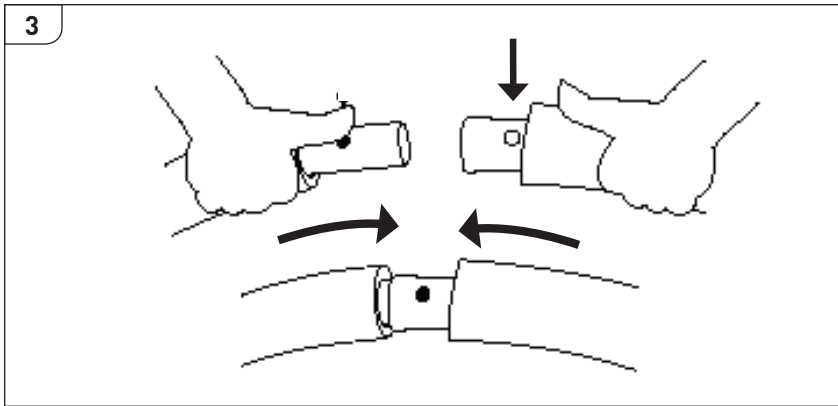

STEP 3:

Grab Handle Arch - Female (Part D/F) and Handle Arch - Male (Part D/M) and connect them to form the arch handle. The Handle Arch - Male, has a snap button that must be pressed and pushed when sliding into the Handle Arch -Female. You will hear a “click” when the button has properly locked into the hole.

To avoid pinching when in use, push foams into each other at the top of the arches to cover completely the connecting area.

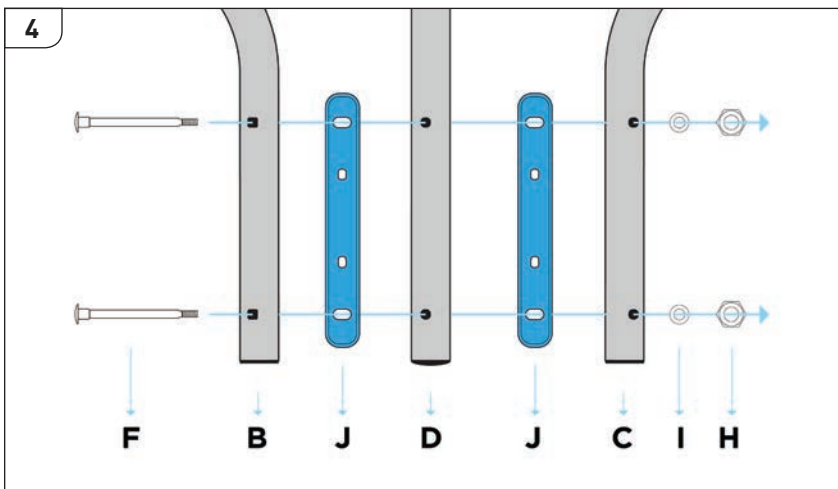

STEP 4:

To connect all trampoline legs and arch legs in the front of the trampoline, you will need the following Parts: Long Bolt (Part F), Spacers (Part J), Washers (Part I), and Nuts (Part H). Follow the order shown to properly assemble the legs.

Make sure to insert the Bolt into Frame Leg with Square Opening to keep part secure and in place, with remainder of bolt sticking out from Frame Leg with Round Opening once all parts are in order. This will allow you to place the Washer and Nut properly.

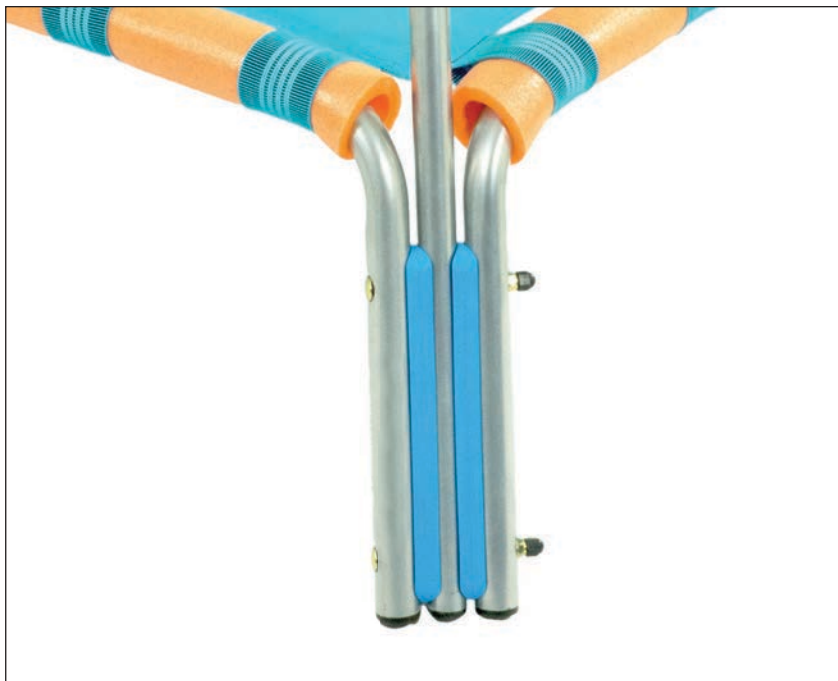

NOTE:

You might need another adult to help you in this section. The tension from the Jumping Mat will make it difficult for parts to stay in place. Having someone to hold all the parts together while installing the legs can be helpful.

NOTE:

Do not tighten Nuts until beginning of step 6. This will avoid too much tension on legs.

ASSEMBLY INSTRUCTIONS

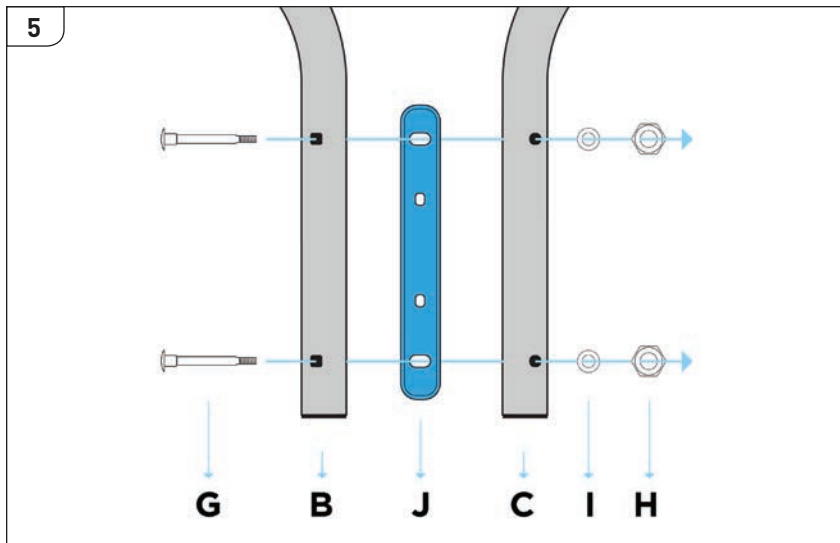

STEP 5:

Once the front legs of the Trampoline have been assembled and the Arch handle properly installed, you may begin putting together the parts for the back legs of the trampoline. You will need the following Parts: Short Bolt (Part G), Spacers (Part J), Washers (Part I), and Nuts (Part H). Follow the order shown below to properly assemble the legs.

Make sure to insert the Bolt into Frame Leg with Square Opening to keep part secure and in place, with remainder of bolt sticking out from Frame Leg with Round Opening once all parts are in order. This will allow you to place the washer and Nut properly.



NOTE:

You might need another adult to help you in this section. The tension from the Jumping Mat will make it difficult for parts to stay in place. Having someone to hold all the parts together while installing the legs can be helpful.

NOTE:

Do not tighten Nuts until beginning of step 6. This will avoid too much tension on legs.

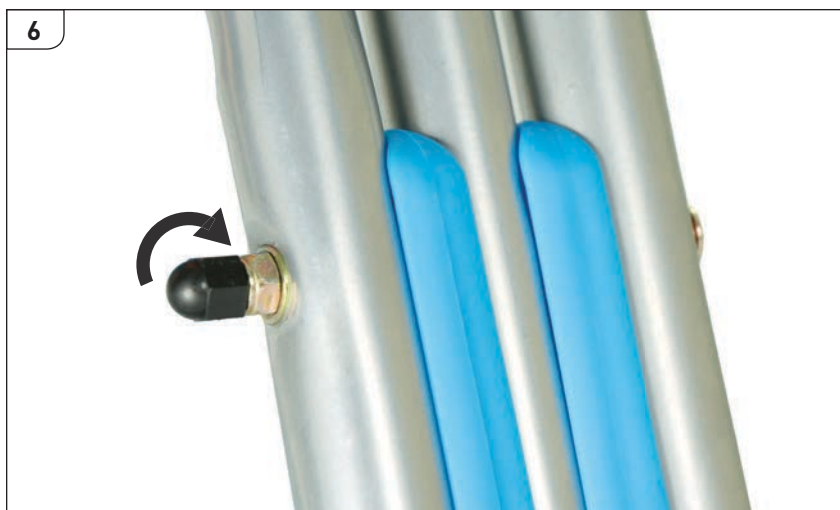

STEP 6:

Once all legs are properly installed, you may begin to tighten the Nuts to ensure they are properly attached and secure. Doing so will give you enough space to place the Black Cap (Part K).

NOTE:

Make sure to place all 8 Black Caps on the bolts. Failure to inspect that all parts are properly installed on the product before use, can cause injury, scratches, and/or cuts.

FREQUENTLY ASKED QUESTIONS

- Question: "The foam padding or mat is damaged, what should I do?"

If you are still within your warranty period, you should contact our customer service department. You can also purchase replacement parts from our website: www.PureFun.net

- Question: "I had a part missing from my box" or "something was damaged in shipping, can you send it to me?"

Answer: If it has been 30 days or less from the date of your initial purchase, you can contact customer service (info below) for a replacement part to be issued.

- Question: The trampoline is not resting completely flat. What can I do?

If the trampoline is not flat, then there is too much tension on the fittings of the tubes. Press the trampoline diagonally, or bend a bit of the leg that doesn't touch the ground to level all legs. (See Fig. 1 and Fig. 2)

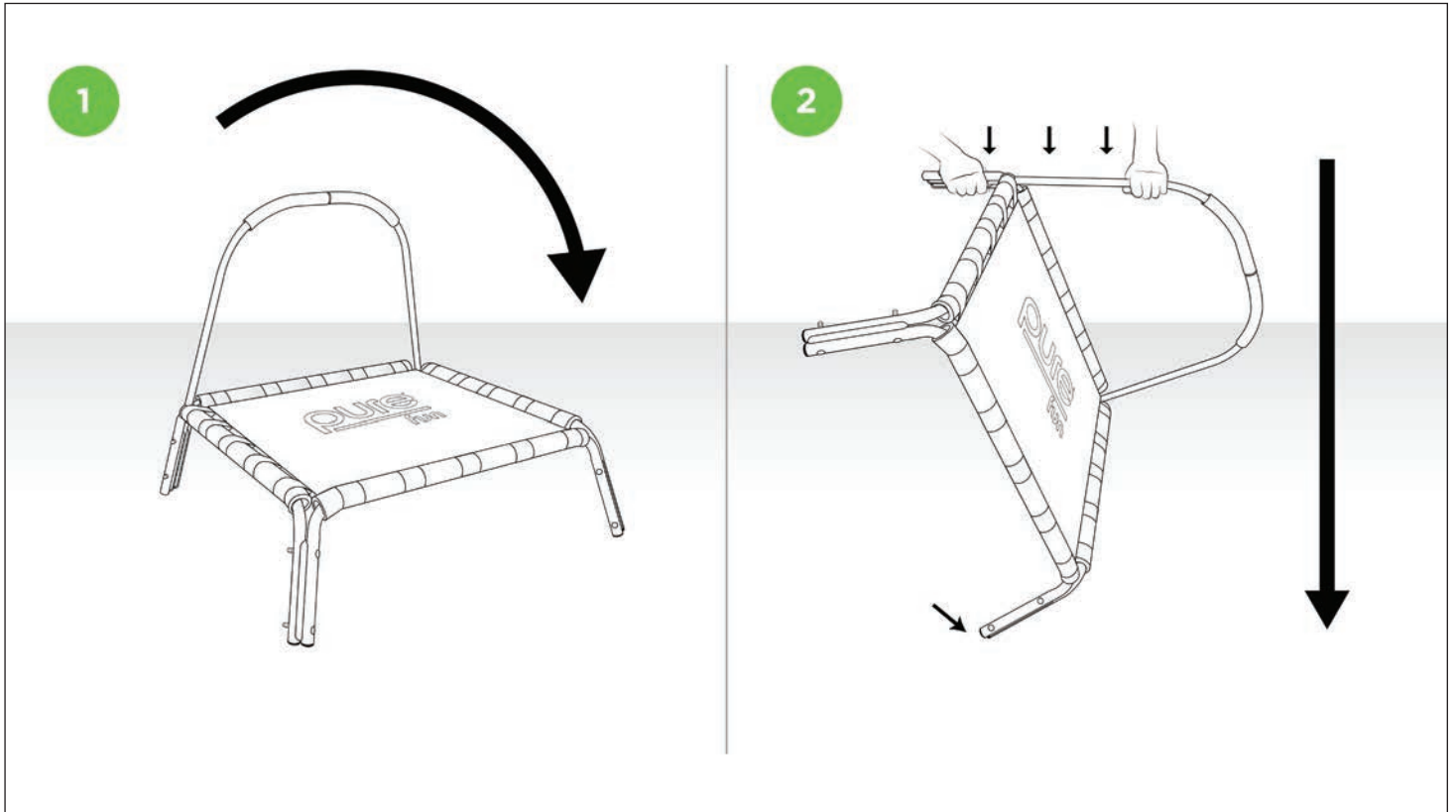

CARE AND MAINTENANCE

- Your trampoline is designed to be very low maintenance.
- If any part of the trampoline requires cleaning, simply wipe with a damp cloth. (Do not jump on the trampoline after cleaning until completely dry).
- If the paint is chipped, we recommend you lightly rub the damaged area and cover using a non-toxic enamel paint.
- **IMPORTANT:** While no regular maintenance is required, you must inspect the trampoline before each use and replace any worn, defective or missing parts.
- The following conditions could represent potential hazards: missing, improperly positioned, or insecurely attached frame padding; punctures, frays, tears, or holes worn in the bed or frame padding; deterioration in the stitching or fabric of the bed or frame padding; a bent or broken frame; a sagging jump mat; sharp protrusions on the frame or suspension system. Cease using trampoline immediately and secure it against unauthorized use if any of these conditions are present.

