

FLOOR DRAINS



INNOVATIVE SOLUTIONS FOR CERAMIC AND STONE TILE

FLOOR DRAINS FOR BONDED WATERPROOF MEMBRANES

Schluter®-KERDI-DRAIN and Schluter®-KERDI-LINE floor drains provide a simple and secure connection to bonded waterproof membranes at the top of the assembly via an integrated bonding flange. Thus, the membrane is applied entirely at the surface, with all water directed into the top of the drain.

Application and Function

Schluter®-KERDI-DRAIN and Schluter®-KERDI-LINE are specifically designed for use in bonded waterproofing assemblies, such as showers, steam rooms, wet rooms, bathroom floors, commercial kitchen floors and other applications that require waterproofing and drainage.

8.2 Schluter®-KERDI-DRAIN is a floor drain specifically designed to allow connections to Schluter®-KERDI or other load-bearing, bonded waterproof membranes. The membrane is adhered to the large integrated bonding flange to form a waterproof connection at the top of the drain assembly. KERDI-DRAIN consists of a drain casing and fully adjustable grate assembly or covering support to which tile is applied. The grate assembly accommodates a wide range of tile thicknesses and allows lateral and tilt adjustment as well. The covering support is placed flush with the top of the bonding flange and can therefore accommodate any thickness tile covering.

The standard KERDI-DRAIN is attached directly to the waste line. The drain casing is available in ABS, PVC, or stainless steel. The plastic drain casings feature a fleece-covered bonding flange. They are available with standard 2" (50 mm) and 3" (75 mm) outlets and attached to the pipe using an appropriate solvent cement. The stainless steel drain casings are available with standard 2" (50 mm) and 3" (75 mm) no-hub outlets and 2" (50 mm) threaded outlet. The no-hub outlets are attached to the pipe using

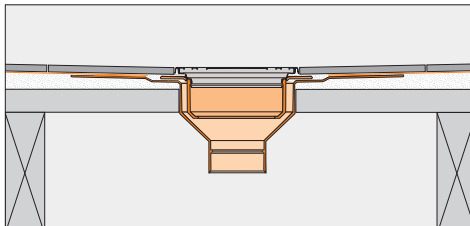

8.2 Schluter®-KERDI-DRAIN

an appropriate mechanical (e.g., flexible or no-hub) coupling. The threaded outlets are attached to the pipe using thread sealing compound or tape. The simple connection to standard drain outlets makes KERDI-DRAIN suitable for new construction and renovation.

The KERDI-DRAIN adaptor kit is designed to convert clamping ring drains by equipping them with an integrated bonding flange. The adaptor kit includes a stainless steel adaptor ring with an over-molded rubber gasket and a variety of perforated hole patterns that align with most common clamping ring shower drains. The adaptor ring replaces the clamping ring and is attached to the drain body using the clamping ring bolts. This connection is made watertight via the rubber gasket and Schluter®-KERDI-FIX adhesive/sealant. The integrated bonding flange slides into the adaptor ring, with the over-molded rubber gasket ensuring

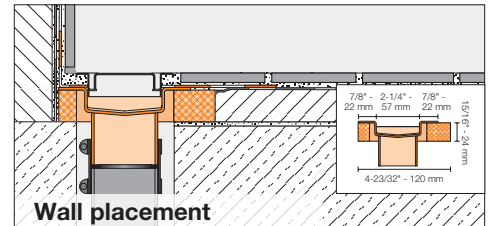
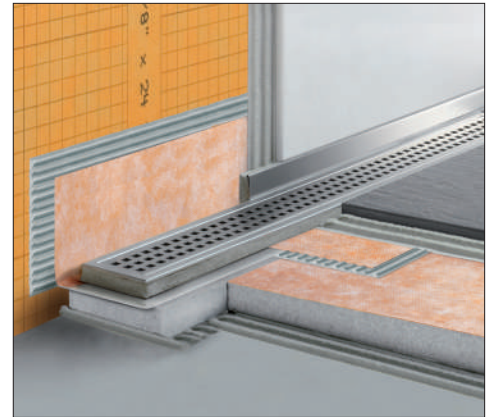

Wall placement

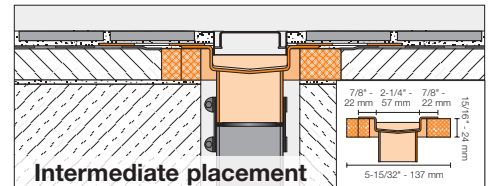

Intermediate placement

8.7 Schluter®-KERDI-LINE

a watertight seal. KERDI-DRAIN ADAPTOR KITS, available in 5-1/4" (133 mm) and 7-1/2" (191 mm) diameter sizes, are used to convert traditional clamping ring drains to integrated bonding flange drains when removal of the clamping ring drain is not practical (e.g., when they are set in concrete slabs). Adaptor kits are suitable for both mortar beds and KERDI-SHOWER-T/-TS/-TT shower tray applications.

The KERDI-DRAIN grate assembly consists of a frame, which can be seamlessly adjusted to the thickness and layout of the ceramic tile or stone covering via the height adjustment



collar and lateral adjustment ring, and grates or cleanout covers that are placed within the frame. The 4" (100 mm) standard grate assembly frame features an approximately 1/8" (3 mm) wide reveal after installation and grate/frame combinations are available in stainless steel with plain, chrome, nickel, classic gold, vintage gold, rose gold, or oil-rubbed bronze finish and anodized aluminum with brushed nickel, brushed copper, or brushed brass finish. The 4" (100 mm) style grate assembly frame features a minimal reveal after installation and can be combined with one of three grate options: Floral (E), Curve (F), or Pure (G). The style grates are available in brushed stainless steel with plain, nickel, classic gold, vintage gold, or rose gold finishes and a range of textured color-coated finishes including stone grey, cream, greige, bronze, matte black and matte white. The 4" (100 mm) covering support is a square stainless steel plate with KERDI laminated on the surface to allow for bonding of ceramic or stone tile, which creates a virtually invisible drainage line. The 6" (150 mm) square and round stainless steel grate assembly frames feature an approximately 3/16" (5 mm) wide reveal after installation and can be combined with stainless steel grates or cleanout covers. Please note that grate assemblies included with the plastic KERDI-DRAIN featuring 3" (75 mm) outlets and the residential adaptor kits only allow vertical and tilt adjustment (no lateral adjustment).

8.7 Schluter®-KERDI-LINE is a low profile linear floor drain specifically designed for bonded waterproofing assemblies. KERDI-LINE can be installed adjacent to walls or at intermediate locations. The floor can be sloped on a single plane to KERDI-LINE, which enables the use of large-format tiles and creates interesting design opportunities.

KERDI-LINE consists of a formed stainless steel channel body and grate assembly or covering support to which tile is applied.

The channel body features a standard 2" (50 mm) no-hub outlet and is attached to the pipe using an appropriate mechanical (e.g., flexible or no-hub) coupling. The simple connection to standard drain outlets makes KERDI-LINE suitable for new construction and renovation. KERDI-LINE is available with both center and off-set outlets. The off-set outlet is located 8" (20.3 cm) from the edge of the channel body and provides flexibility when obstacles (e.g., floor joists) are encountered during installation. KERDI-LINE includes a corresponding polystyrene foam channel support to set the drain elevation to the corresponding KERDI-SHOWER-LT/-LTS shower trays. The perimeter of the channel body consists of a bonding flange laminated with a collar made of KERDI. It

ensures a simple and secure connection to the bonded waterproofing assembly, both in the floor area and on adjacent walls. KERDI-LINE is available in channel lengths from 20" to 72" (50 cm to 180 cm) in 4" (10 cm) increments. The bonding flange extends approximately 1" (2.5 cm) beyond the channel on all sides.

The KERDI-LINE grate assembly consists of a stainless steel frame that can be seamlessly adjusted to the thickness of the ceramic tile or stone covering – 1/8" to 1" (3 mm to 25 mm) for standard grate assemblies and 1/4" to 23/32" (6 mm to 18 mm) for style grate assemblies – and stainless steel grates that are placed within the frame. The standard grate assembly frame features a 3/8" (10 mm) wide reveal after installation and can be combined with one of two grate options: Closed (A) or Perforated (B). Each standard assembly is available in a brushed or chrome finish. The Perforated (B) option is also available with a locking mechanism (brushed stainless steel, 3/4" – 19 mm frame only) for applications where tamper resistance is desired or required (e.g., healthcare and education facilities, etc.). The style grate assembly frame features a minimal reveal after installation and can be combined with one of three grate options: Floral (E), Curve (F), or Pure (G). Each style assembly is available in a brushed finish. The covering support is placed flush with the top of the channel body and can therefore accommodate any thickness tile covering.

If KERDI-LINE is placed at shower entrance, it is recommended that grate assembly A or the covering support is chosen and that the drainage openings span the maximum width of the entrance to limit potential overflow; secondary drainage (e.g., KERDI-DRAIN) may be required in the drying area.

Schluter®-KERDI-LINE-FC is a stainless steel cover plate for use with KERDI-LINE to create a seamless look in applications where multiple drains are installed end-to-end. KERDI-LINE-FC is available in a brushed or chrome finish, and is designed for use with either the solid or perforated grates with brushed stainless steel frame.

Material Properties and Areas of Application

KERDI-DRAIN and KERDI-LINE are suitable for use in residential and commercial applications, including areas subject to foot and wheelchair traffic, such as showers and wet rooms in homes, hotels, schools, healthcare facilities, etc.

Various configurations of KERDI-DRAIN and KERDI-LINE are listed by UPC®, CSA, and ICC-ES PMG. Relevant industry standard guidelines

for floor drains with integrated bonding flange include methods B422, B422C, SR613 and SR614 in the Tile Council of North America's (TCNA) Handbook for Ceramic Tile Installation and Method 326DR in the Terrazzo, Tile and Marble Association of Canada (TTMAC) Specification Guide 093000 Tile Installation Manual.

KERDI-DRAIN flanges are formed using ABS, PVC, or stainless steel 304 (1.4301 = V2A). Plastic drain flanges feature a polypropylene fleece webbing on the surface of the bonding flange to accept a bond to thin-set mortar. The KERDI-DRAIN adaptor kits feature adaptor rings made of stainless steel 304 (1.4301 = V2A) with thermoplastic rubber gaskets and adaptor flanges made of ABS. Drain grates are available in plain and coated stainless steel 304 (1.4301 = V2A) and anodized aluminum. The covering support is stainless steel 304 (1.4301 = V2A) with KERDI laminated on the surface.

The KERDI-LINE channel body is formed using stainless steel 316 L (1.4404 = V4A) and features a bonding flange with a KERDI collar laminated on the surface. KERDI is a bonded waterproof membrane with a modified polyethylene (PEVA) with non-woven polypropylene fleece on both sides to anchor the membrane in the thin-set mortar. The frame and grates are made of stainless steel 316 L (1.4404 = V4A). The channel support is made of pressure-resistant, expanded polystyrene (EPS). The KERDI-LINE-FC cover plate is roll-formed using stainless steel 316 L (1.4404 = V4A). The SHOWERPROFILE-S anchoring leg is made of recycled, rigid PVC. The SHOWERPROFILE-S/-R profiles are made of stainless steel 316 L (1.4404 = V4A) with KERDI laminated on the backside.

Schluter®-Systems drain grates are resistant to most chemicals encountered in tiled environments. In special cases, the suitability of a proposed type of material must be verified based on the anticipated chemical, mechanical, and/or other stresses. In general, grates should be protected against abrasion or scratching. Exceptions and special considerations are listed below.

Stainless steel can sustain high mechanical stresses and is particularly well suited for applications requiring resistance against chemicals and acids. For more severe chemical exposure, such as de-icing salts and chemicals used in swimming pools, we recommend the use of stainless steel 316 L, which offers even higher corrosion resistance than the 304. Even stainless steel cannot withstand all chemical exposures, such as hydrochloric acid, hydrofluoric acid or certain chlorine, chloride and brine concentrations.

Metallic-coated grates are stainless steel 304 with a metallic coating created using physical vapor deposition (PVD). The resulting metallic film is very hard and corrosion-resistant.

Textured color-coated grates are stainless steel with a powder coat.

Anodized aluminum grates feature an anodized layer that retains a uniform appearance during normal use. The surface may be damaged by grout or setting material. Therefore, these materials must be removed immediately.

Installation

The installation instructions below represent the use of KERDI-DRAIN and KERDI-LINE in floor applications. Installation instructions for the use of KERDI-DRAIN and KERDI-LINE in shower applications can be found in the Schluter®-Shower System Installation Handbook.

KERDI-DRAIN

Preparation

After locating the correct position, cut a hole in the substrate for the drain outlet and coupling to the waste line using the template provided. Note: Fill in box-outs in concrete floors with dry-pack mortar. A pipe coupling or similar can be used as a form around the waste line. Select form to accommodate the drain outlet and mechanical no-hub coupling (when applicable). Limit the diameter of the hole to 5" (125 mm) maximum to ensure proper support of the tile assembly. A larger hole can lead to lack of support and damage the tile assembly (e.g., cracked grout around drain).

Drain installation

Access to plumbing from below

If there is access to the plumbing from below and the waste line can be connected after installing KERDI-DRAIN, the drain can be installed in conjunction with the mortar bed.

1. Place a ring of loose mortar up to the inlet hole in the floor and firmly press the drain into the mortar. The bonding flange must be fully supported to prevent damage to the tile assembly (e.g., cracked grout around drain). When installing KERDI-DRAIN over wood substrates, the minimum thickness of mortar required at the perimeter of the bonding flange is 1" (25 mm).
2. The screed is then placed flush with the top of the bonding flange of the KERDI-DRAIN. Slope the mortar bed using the bonding flange and mortar screeds as guides.

No access to plumbing from below

When there is no access to the plumbing from below, install the KERDI-DRAIN to the appropriate height prior to the installation of the shower base.

1. Begin the drain installation by dry fitting the components. Measure and cut a section of pipe to connect the KERDI-DRAIN to the odor trap below the floor, using the foam spacers included with the drain as a spacer. When installing KERDI-DRAIN over wood substrates, the minimum thickness of mortar required at the perimeter of the bonding flange is 1" (25 mm).
2. Prepare the odor trap, cut section of pipe, and KERDI-DRAIN with cleaner, primer and ABS or PVC cement per the solvent cement manufacturer's instructions and connect. Use a no-hub coupling for stainless steel drains with no-hub outlets, and thread sealing compound or tape for stainless steel drains with threaded outlets.
3. Pack loose mortar under the drain up to the inlet hole to ensure solid and uniform support of the bonding flange. The screed is then placed flush with the top of the bonding flange of the KERDI-DRAIN. Slope the mortar bed using the bonding flange and mortar screeds as guides.

Clamping ring drain already installed

If a clamping ring drain is already installed, the drain must be replaced with KERDI-DRAIN or converted using the KERDI-DRAIN adaptor kit.

1. If using the KERDI-DRAIN adaptor kit, remove the clamping ring from the installed drain and save the bolts for installation of the adaptor ring. Align the bolt pattern of the clamping ring with the matching punch-outs in the adaptor ring. Punch the matching inserts out through the stainless steel adaptor ring.
2. Apply a continuous 1/4" - 3/8" (6 - 10 mm) bead of KERDI-FIX to the underside of the adaptor ring. Align the holes in the adaptor ring with the bolt holes in the installed drain and place the adaptor ring on the installed drain flange. Re-insert and tighten the bolts using a star pattern. Bolts are to be finger-tight plus 1/4 turn; do not overtighten, as this may warp the adaptor ring and result in leaks.
3. Slide the adaptor flange into the adaptor ring and ensure full support under the adaptor flange with mortar. The screed is then placed flush with the top of the bonding flange of the KERDI-DRAIN. Slope the mortar bed using the bonding flange and mortar screeds as guides.

Note: Schluter®-Systems strongly recommends a leak test be performed on the connection between the drain and waste line prior to continuing on with the remainder of the installation whenever possible. Refer to local plumbing and/or building codes for any specific requirements in your area.

Connection to waterproofing membranes

The KERDI or DITRA waterproofing membranes can be installed over the mortar bed as soon as it can be walked upon.

KERDI

1. Apply Schluter SET®, Schluter ALL-SET®, Schluter FAST-SET® or unmodified thin-set mortar to the bonding flange and surrounding mortar bed with a 1/4" x 3/16" (6 x 5 mm) V-notched trowel or the KERDI-TROWEL, which features a 1/8" x 1/8" (3 x 3 mm) square-notched design. The thin-set mortar must be mixed to a fairly fluid consistency, but still able to hold a notch.

Note: When using the stainless steel bonding flange, the membrane is bonded to the integrated bonding flange with KERDI-FIX adhesive/sealant. The stainless steel bonding flange must be clean and free of grease or other contaminants prior to KERDI-FIX application.
2. Embed KERDI in the bond coat and work the membrane onto the KERDI-DRAIN bonding flange and mortar bed with the flat side of the trowel to ensure full coverage and remove air pockets. The membrane is carried to the step in the bonding flange (template provided).

DITRA or DITRA-XL

1. DITRA or DITRA-XL is installed up to the outer edge of the KERDI-DRAIN bonding flange. Apply Schluter SET®, Schluter ALL-SET®, Schluter FAST-SET® or unmodified thin-set mortar to the mortar bed surrounding KERDI-DRAIN with a 1/4" x 3/16" (6 x 5 mm) V-notched trowel or the DITRA-TROWEL, which features an 11/64" x 11/64" (4.5 x 4.5 mm) square-notched design. The thin-set mortar must be mixed to a fairly fluid consistency, but still able to hold a notch. Solidly embed the matting into the bond coat using a float, screed trowel, or DITRA-ROLLER.
2. DITRA or DITRA-XL is sealed to the KERDI-DRAIN bonding flange using a cut section of the KERDI membrane. Apply Schluter SET®, Schluter ALL-SET®, Schluter FAST-SET® or unmodified thin-set mortar to the bonding flange and surrounding membrane with a 1/4" x 3/16" (6 x 5 mm) V-notched trowel or the KERDI-TROWEL, which features a 1/8" x 1/8" (3 x 3 mm) square-notched design.

Note: When using the stainless steel bonding flange, the KERDI is bonded to the integrated bonding flange with KERDI-FIX adhesive/sealant. The stainless steel bonding flange must be clean and free of grease or other contaminants prior to KERDI-FIX application.

- Embed a 20" x 20" (50 x 50 cm) cut section of KERDI in the bond coat and work the membrane onto the KERDI-DRAIN bonding flange and surrounding membrane to ensure full coverage and remove air pockets. The KERDI is carried to the step in the bonding flange (template provided) and must overlap the DITRA or DITRA-XL membrane by a minimum of 2" (50 mm).

Grate assembly

Grate

- The grate assembly is installed in conjunction with the tile. Place the height adjustment collar inside the lateral adjustment ring and snap the grate frame into place.
Note: For drains with 6" (150 mm) grates, the height adjustment collar is integrated with the grate. For the residential adaptor kit, there is no lateral adjustment ring.
- Fill the step in the bonding flange with Schluter SET®, Schluter ALL-SET®, Schluter FAST-SET® or unmodified thin-set mortar and back-butter the underside of the grate frame to ensure full support. Press the assembly into the mortar and install the surrounding tiles, ensuring full coverage.
- Position the grate to match the joint pattern of the tile covering and press flush with the tile surface. Remove all excess setting material.

Note: Protect the visible surface of the grate from contact with setting and grouting materials. In particular, anodized aluminum is sensitive to alkaline materials.

Tileable Covering Support

- The covering support is installed in conjunction with the tile. Place the tile spacer inside the lateral adjustment ring.
- Fill the step in the bonding flange with thin-set mortar and press the assembly into the mortar. Install the surrounding tiles up to the tile spacer using Schluter SET®, Schluter ALL-SET®, Schluter FAST-SET® or unmodified thin-set mortar, ensuring full coverage. Set the tile to the integrated tabs on the lateral adjustment ring, which provide for a flush transition to the covering support. Remove all excess setting material. Position the tile spacer to match the joint pattern of the tile covering.
- Apply tile to the top of the covering support using Schluter SET®, Schluter ALL-SET®, Schluter FAST-SET® or unmodified thin-set mortar. The tile is installed flush with all sides of the covering support to provide the drainage openings.
- Once the assembly has been set and grouted, remove the tile spacer and insert the tiled covering support in the lateral adjustment ring.

Note: For acid-resistant coverings, use an epoxy adhesive to set and grout the tile.

KERDI-LINE

Preparation

When installing KERDI-LINE against a wall, be sure to factor in wall board thickness before cutting the hole in the substrate.

- Any leveling of the floor must be done prior to the installation of the channel body. For installation adjacent to the wall, the channel body must be aligned in accordance with the thickness of the wall covering. For intermediate installation, use the supplied filling strip with peel-and-stick adhesive layer to make the channel support symmetrical.
- KERDI-LINE can be installed in conjunction with the provided channel support as described below or set in loose mortar. KERDI-LINE is connected to the waste line with the appropriate mechanical no-hub coupling in accordance with the coupling manufacturer's instructions.

Channel body installation

Access to plumbing from below

When there is access to the plumbing from below and the waste line can be connected after installing KERDI-LINE, the channel body may be set without making a connection to the waste line simultaneously.

- Apply Schluter SET®, Schluter ALL-SET®, Schluter FAST-SET® or unmodified thin-set mortar to the substrate where the drain is to be placed with a notched trowel and solidly embed the channel support in the mortar.
- Apply Schluter SET®, Schluter ALL-SET®, Schluter FAST-SET® or unmodified thin-set mortar to the top of the channel support with a notched trowel and press the channel body firmly into the mortar, ensuring full support of the bonding flange. Check to make sure the KERDI-LINE is level.

No access to plumbing from below

When there is no access to the plumbing from below, the channel body must be set and connected to the waste line simultaneously.

- Begin the drain installation by dry fitting the components. Measure and cut a section of pipe to connect the coupling to the odor trap below the floor, using the channel support as a spacer.
- Apply Schluter SET®, Schluter ALL-SET®, Schluter FAST-SET® or unmodified thin-set mortar to the top of the channel support with a notched trowel and press the channel support firmly onto the underside of the channel body. Attach the mechanical coupling to the drain outlet and

the cut section of the pipe per the coupling manufacturer's instructions.

- Apply Schluter SET®, Schluter ALL-SET®, Schluter FAST-SET® or unmodified thin-set mortar to the substrate where the drain is to be placed with a notched trowel. Prepare the cut section of pipe and odor trap with cleaner, primer and ABS or PVC cement per the solvent cement manufacturer's instructions.
- Solidly embed the channel support and KERDI-LINE into the mortar on the floor and connect the cut section of pipe to the odor trap. Check to make sure the KERDI-LINE is level.
- The screed is then placed flush with the top of the bonding flange of the KERDI-LINE. Slope the mortar bed using the bonding flange and mortar screeds as guides.
Note: KERDI-FIX or other adhesives that are compatible with EPS foam can be used to install the channel support and channel body as an alternative to thin-set mortar. Apply a generous bead of KERDI-FIX to the top and bottom of the channel support. The use of KERDI-FIX limits the ability to level KERDI-LINE.
Note: Schluter®-Systems strongly recommends a leak test be performed on the connection between the drain and waste line prior to continuing on with the remainder of the installation whenever possible. Refer to local plumbing and/or building codes for any specific requirements in your area.

Connection to waterproofing membranes

The KERDI or DITRA waterproofing membranes can be installed as soon as the mortar bed can be walked upon.

- KERDI, DITRA or DITRA-XL is installed up to the outer edge of the KERDI-LINE bonding flange using Schluter SET®, Schluter ALL-SET®, Schluter FAST-SET® or unmodified thin-set mortar. The thin-set mortar must be mixed to a fairly fluid consistency, but still able to hold a notch.
 - KERDI:** Apply Schluter SET®, Schluter ALL-SET®, Schluter FAST-SET® or unmodified thin-set mortar to the mortar bed surrounding KERDI-LINE with a 1/4" x 3/16" (6 x 5 mm) V-notched trowel or the KERDI-TROWEL, which features a 1/8" x 1/8" (3 x 3 mm) square-notched design. Embed KERDI in the bond coat with the flat side of the trowel to ensure full coverage and remove air pockets.
 - DITRA:** Apply Schluter SET®, Schluter ALL-SET®, Schluter FAST-SET® or unmodified thin-set mortar to the mortar bed surrounding KERDI-LINE with a 1/4" x 3/16" (6 x

5 mm) V-notched trowel or the DITRA-TROWEL, which features an 11/64" x 11/64" (4.5 x 4.5 mm) square-notched design. Solidly embed the matting into the bond coat using a float, screed trowel, or DITRA-ROLLER.

2. Apply Schluter SET®, Schluter ALL-SET®, Schluter FAST-SET® or unmodified thin-set mortar to the membrane surrounding KERDI-LINE with a 1/4" x 3/16" (6 x 5 mm) V-notched trowel or the KERDI-TROWEL, which features a 1/8" x 1/8" (3 x 3 mm) square-notched design. Embed the KERDI collar in the bond coat to ensure full coverage and remove air pockets.

Grate assembly

Grate

1. Apply Schluter SET®, Schluter ALL-SET®, Schluter FAST-SET® or unmodified thin-set mortar to the underside of the grate frame and place it in the channel body ensuring full coverage and support of the frame. Insert the foam spacers in the grate frame to reinforce it during the remainder of the installation.

Note: The tape on the grate frame does not need to be removed. It is intended to help keep setting material out of the channel body during installation.

2. Slide the plastic height adjustment spacers with threaded bolts onto the tabs along the inside of the grate frame to adjust the elevation of the frame. The spacers may be adjusted simply by turning the bolts by hand. The elevation should be set such that the frame will be flush with the surface of the tile covering.
3. Apply Schluter SET®, Schluter ALL-SET®, Schluter FAST-SET® or unmodified thin-set mortar to the substrate and install the tiles, ensuring full coverage. Once the tile covering is set and grouted, remove the spacers from the grate frame and insert the grate.

Note: Protect the visible surfaces of the grate frame and grate from contact with setting and grouting materials. Setting and grouting materials must be removed immediately.

KERDI-LINE-FC

1. Install KERDI-LINE channel bodies end-to-end and overlap the KERDI collars using Schluter SET®, Schluter ALL-SET®, Schluter FAST-SET® or unmodified thin-set mortar to ensure a waterproof connection. KERDI-LINE-FC is subsequently installed in conjunction with the KERDI-LINE grate assembly and adjacent tiles.

Note: KERDI-LINE-FC may be used with tiles that are 1/4" (6 mm) thick or greater.

2. Apply a sufficient amount of thin-set mortar to the substrate and/or the back of KERDI-

LINE-FC and press the profile into the mortar until its surface is flush with the adjacent tile and grate assembly.

3. Leave a space of approximately 1/16" – 1/8" (1.5 – 3 mm).
4. Fill the joints completely with grout or setting material.

Tileable Covering Support

Wall Installation

1. Peel protective foil off the cover strip and adhere the strip to the bonding flange adjacent to the wall(s). Position the strip along the edge of the channel. The cover strip hides and protects the KERDI surface under the tile.
2. Insert the tile spacers into the channel body. Install the surrounding tile on the adjoining walls and mortar bed up to the spacers using Schluter SET®, Schluter ALL-SET®, Schluter FAST-SET® or unmodified thin-set mortar, ensuring full coverage. Remove all excess setting material.

3. Apply tile to the top of the covering support using Schluter SET®, Schluter ALL-SET®, Schluter FAST-SET® or unmodified thin-set mortar. The tile is installed flush with the front side of the covering support to provide the drainage opening and overhanging the back side of the covering support to cover the bonding flange along the wall. Measure and cut the tile such that an approximate 1/16" (1 mm) gap is left at the wall. When the ends of the channel body are located adjacent to walls, the tile is installed overhanging the end of the plate to cover the bonding flange along the walls. Measure and cut the tile such that an approximate 1/16" (1 mm) gap is left at the walls.

Note: When the mortar bed is tiled beyond the ends of the channel, the tile on the ends of the covering support can be cut to either match the grout joints of the surrounding floor covering or to provide a perimeter drainage opening.

Intermediate Installation

1. When the ends of the channel body are located adjacent to walls, peel protective foil off the cover strip and adhere the strip to the bonding flange adjacent to the walls. Position the strip along the edge of the channel. The cover strip hides and protects the KERDI surface under the tile. When the mortar bed will be tiled beyond the ends of the channel, the cover strip is not required.
2. Insert the tile spacers into the channel body. Install the surrounding tile on the adjoining walls (if applicable) and mortar bed up to the spacers using Schluter SET®, Schluter ALL-SET®, Schluter FAST-SET® or unmodified thin-set mortar, ensuring full coverage. Remove all excess setting material.

3. Apply tile to the top of the covering support using thin-set mortar. The tile is installed flush with the front and back of the covering support to provide the drainage openings. When the ends of the channel body are located adjacent to walls, the tile is installed overhanging the end of the plate to cover the bonding flange along the wall. Measure and cut the tile such that an approximate 1/16" (1 mm) gap is left at the wall.

Note: When the mortar bed is tiled beyond the ends of the channel, the tile on the ends of the covering support can be cut to either match the grout joints of the surrounding floor covering or to provide perimeter drainage openings.

Note: For acid-resistant coverings, use an epoxy adhesive to set and grout the tile.

Maintenance

KERDI-DRAIN and KERDI-LINE require no special maintenance and are resistant to mold and fungi. The grate may be removed to clean the drain housing and the drain pipes.

Clean the grates and profiles using neutral cleaners. Avoid the use of strong acids (e.g., hydrochloric, hydrofluoric) and bases/alkaline cleaners (e.g., bleach, ammonia, chlorides). Do not use abrasive cleaning agents and tools. Even stainless steel requires periodic cleaning, which will maintain a neat appearance and reduce the risk of corrosion. Stainless steel surfaces develop a sheen when treated with a chrome-polishing agent.

Product Item Numbers

8.2 Schluter®-KERDI-DRAIN



4" Grate Options

Tileable Covering Support	Anodized Aluminum			
<p>(ECS) Patent pending</p>	<p>Design 2</p> <p>Available in the following colors and finishes:</p> <table border="1"> <tr> <td>Brushed Nickel (ATGB)</td> <td>Brushed Copper (AKGB)</td> <td>Brushed Brass (AMGB)</td> </tr> </table>	Brushed Nickel (ATGB)	Brushed Copper (AKGB)	Brushed Brass (AMGB)
Brushed Nickel (ATGB)	Brushed Copper (AKGB)	Brushed Brass (AMGB)		

Stainless Steel																					
<p>Design 1</p> <p>Available in the following colors and finishes:</p> <table border="1"> <tr> <td>Stainless Steel (E)</td> <td>Rose Gold (ERG)</td> </tr> <tr> <td>Chrome (EP)</td> <td>Vintage Gold (EVG)</td> </tr> <tr> <td>Oil-rubbed Bronze (EOB)</td> <td>Classic Gold (ECG)</td> </tr> <tr> <td>Nickel (ET)</td> <td></td> </tr> </table>	Stainless Steel (E)	Rose Gold (ERG)	Chrome (EP)	Vintage Gold (EVG)	Oil-rubbed Bronze (EOB)	Classic Gold (ECG)	Nickel (ET)		<p>Pure</p> <p>Curve</p> <p>Floral</p> <p>Available in the following colors and finishes:</p> <table border="1"> <tr> <td>Brushed Stainless Steel (EB)</td> <td>Brushed Classic Gold (EBCG)</td> <td>Stone Grey (TSSG)</td> </tr> <tr> <td>Brushed Nickel (EBT)</td> <td>Cream (TSC)</td> <td>Matte Black (MGS)</td> </tr> <tr> <td>Brushed Rose Gold (EBRG)</td> <td>Greige (TSBG)</td> <td>Matte White (MBW)</td> </tr> <tr> <td>Brushed Vintage Gold (EBVG)</td> <td>Bronze (TSOB)</td> <td></td> </tr> </table>	Brushed Stainless Steel (EB)	Brushed Classic Gold (EBCG)	Stone Grey (TSSG)	Brushed Nickel (EBT)	Cream (TSC)	Matte Black (MGS)	Brushed Rose Gold (EBRG)	Greige (TSBG)	Matte White (MBW)	Brushed Vintage Gold (EBVG)	Bronze (TSOB)	
Stainless Steel (E)	Rose Gold (ERG)																				
Chrome (EP)	Vintage Gold (EVG)																				
Oil-rubbed Bronze (EOB)	Classic Gold (ECG)																				
Nickel (ET)																					
Brushed Stainless Steel (EB)	Brushed Classic Gold (EBCG)	Stone Grey (TSSG)																			
Brushed Nickel (EBT)	Cream (TSC)	Matte Black (MGS)																			
Brushed Rose Gold (EBRG)	Greige (TSBG)	Matte White (MBW)																			
Brushed Vintage Gold (EBVG)	Bronze (TSOB)																				

6" Grate Options

Stainless Steel	Stainless Steel Cover for Cleanout Applications
<p>(6E)</p> <p>(6RE)</p>	<p>(6CE)</p>





Flange Options

ABS - 2" or 3" Outlet	PVC - 2" or 3" Outlet	Stainless Steel - 2" or 3" No-hub Outlet	Stainless Steel - 2" Threaded Outlet

Note: Product listings and certifications can be referenced on page 23.

Schluter®-KERDI-DRAIN

ABS or PVC FLANGE — 2" or 3" OUTLET

2" (50 mm) drain outlet		3" (75 mm) drain outlet	
Material	Item No.	Material	Item No.
 ABS	KD2 FLK ABS	 ABS	KD3 FLK ABS
 PVC	KD2 FLK PVC	 PVC	KD3 FLK PVC

Additional components included



Flange measurements

ABS or PVC

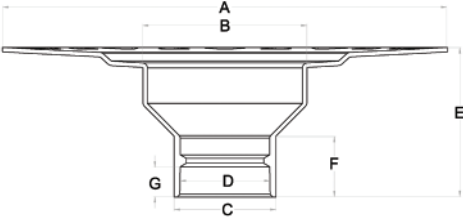
	2" (50 mm) drain outlet		3" (75 mm) drain outlet	
	A	B	C	D
A	11-13/16" - 300 mm	11-13/16" - 300 mm		
B	4-17/32" - 115.2 mm	4-17/32" - 115.2 mm		
C	2-45/64" - 68.6 mm	3-15/16" - 100 mm		
D	2-3/8" - 60.5 mm	3-1/2" - 88.8 mm		
E	3-15/16" - 100 mm	3-15/16" - 100 mm		
F	1-39/64" - 40.6 mm	2" - 50.8 mm		
G	7/8" - 22.5 mm	1-1/2" - 38.1 mm		

i

When using a flange with 3" outlet, a 6" grate is recommended.



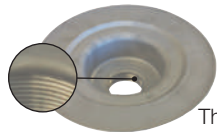

Schluter®-KERDI-DRAIN

STAINLESS STEEL FLANGE – 2" or 3" OUTLET

2" (50 mm) drain outlet	
Material	Item No.
 No-hub	KD2 FLK E
 Threaded	KD2 FLK ETH

3" (75 mm) drain outlet	
Material	Item No.
 No-hub	KD3 FLK E

Additional components included

 **4x** Inside corners
  **2x** Outside corners
  **1x** Pipe seal (3/4" - 20 mm)
  **1x** Mixing valve seal (4-1/2" - 114 mm)
  **1x** KERDI-FIX sealing and bonding compound (3.38 oz - 100 ml)

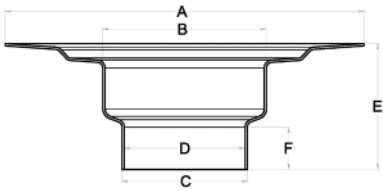

Flange measurements			
Stainless steel			
		2" (50 mm) no-hub outlet	3" (75 mm) no-hub outlet
	A	9-27/32" - 250 mm	9-27/32" - 250 mm
	B	4-1/2" - 115.4 mm	4-1/2" - 114 mm
	C	2-13/32" - 61.3 mm	3-7/16" - 87.4 mm
	D	2-13/32" - 60.6 mm	3-5/16" - 84.2 mm
	E	3-11/32" - 85 mm	3-7/16" - 87.4 mm
	F	53/64" - 21 mm	1-5/32" - 29.4 mm







When using a flange with 3" outlet, a 6" grate is recommended.

Schluter®-KERDI-DRAIN-H

ABS or PVC FLANGE — 2" OUTLET HORIZONTAL

2" (50 mm) drain outlet	
Material	Item No.
 ABS	KDH2 FLK ABS
 PVC	KDH2 FLK PVC

Additional components included			
 4x Inside corners	 2x Outside corners	 1x Pipe seal (3/4" - 20 mm)	 1x Mixing valve seal (4-1/2" - 114 mm)

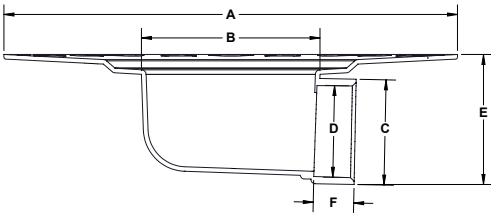
Flange measurements		
ABS or PVC		
	2" (50 mm) horizontal drain outlet	
	A	11-13/16" - 300 mm
	B	4-21/32" - 118.3 mm
	C	2-47/64" - 69.5 mm
	D	2-3/8" - 60.5 mm
	E	3-3/8" - 85.7 mm
	F	1-1/16" - 27 mm

Schluter®-KERDI-SHOWER-CB

Schluter®-KERDI-SHOWER-CB is a height compensation board made of lightweight expanded polystyrene used to accommodate the drain body and waste pipe height, when installing the Schluter®-KERDI-DRAIN-H in conjunction with the Schluter®-KERDI-SHOWER -T/TS/TT shower trays. The compensation board can easily be cut to size to fit around the drain and waste pipe, and multiple boards can be used to fit the size and shape of the shower.

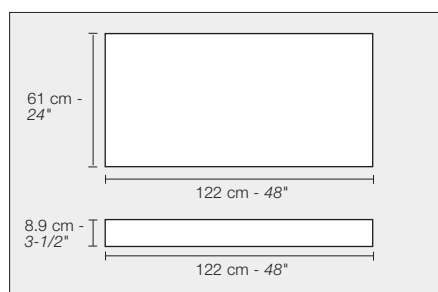

Schluter®-KERDI-SHOWER-CB	
Compensation board	
Item No.	Dimensions
KSCB 90 610 1220	122 cm x 61 cm x 8.9 cm (48" x 24" x 3-1/2")

Schluter®-KERDI-DRAIN-A

ADAPTOR KIT — 5-1/4" or 7-1/2" ADAPTOR RING

Schluter®-KERDI-DRAIN ADAPTOR KITS are used to convert traditional clamping ring drains to integrated bonding flange drains when removal of the clamping ring drain is not practical. A stainless steel adaptor ring with an overmolded rubber gasket replaces the clamping ring and is sealed to the existing drain body using Schluter®-KERDI-FIX. The bonding flange then slides into the adaptor ring and seals against the rubber gasket. Adaptor kits are suitable for both mortar bed and Schluter®-KERDI-SHOWER-T/-TS/-TT shower tray applications.

5-1/4" (133.4 mm) adaptor ring	
Flange and ring	Item No.
<p>5-1/4"</p> <p>Also included: Height adjustment collar for KERDI-DRAIN grate</p>	KDA5 FLK ABS

7-1/2" (191 mm) adaptor ring	
Flange and ring	Item No.
<p>7-1/2"</p> <p>Also included: Lateral adjustment ring for KERDI-DRAIN grate</p>	KDA7 FLK ABS

Additional components included

	4x Inside corners		2x Outside corners		1x Pipe seal (3/4" - 20 mm)		1x Mixing valve seal (4-1/2" - 114 mm)		1x KERDI-FIX sealing and bonding compound (3.38 oz - 100 ml)
--	-----------------------------	--	------------------------------	--	---------------------------------------	--	--	--	--

Flange and adaptor ring measurements	
ABS	
	5-1/4"
	A 11-13/16" - 300 mm
	B 2-13/32" - 60.7 mm
	C 2-23/32" - 69.3 mm
	D 5-1/4" - 133.4 mm
	E 2-29/32" - 74 mm
	F 1-1/64" - 25.9 mm
	G 2-1/16" - 52.6 mm

Flange and adaptor ring measurements	
ABS	
	7-1/2"
	A 11-13/16" - 300 mm
	B 4-13/32" - 111.8 mm
	C 4-11/16" - 118.9 mm
	D 7-1/2" - 191 mm
	E 5-7/64" - 130 mm
	F 3-1/16" - 77.8 mm
	G 3-41/64" - 92.4 mm



The tileable grate and the 6" round/square grates are **NOT** compatible with the 5-1/4" ring flange.

Schluter®-KERDI-DRAIN

GRATES FOR USE WITH FLANGES WITH 2" OUTLET

4" (100 mm) Grate

NEW! Schluter®-KERDI-DRAIN-STYLE

Pure

U.S. Patent No. D831,795



Brushed stainless steel	Brushed nickel	Brushed rose gold	Brushed vintage gold	Brushed classic gold
Item No.	Item No.	Item No.	Item No.	Item No.
KDIF4 GRK EB D8	KDIF4 GRK EBT D8	KDIF4 GRK EBRG D8	KDIF4 GRK EBVG D8	KDIF4 GRK EBCG D8



Cream	Greige	Stone grey	Bronze	Matte white	Matte black
Item No.	Item No.	Item No.	Item No.	Item No.	Item No.
KDIF4 GRK TSC D8	KDIF4 GRK TSBG D8	KDIF4 GRK TSSG D8	KDIF4 GRK TSOB D8	KDIF4 GRK MBW D8	KDIF4 GRK MGS D8

Curve

U.S. Patent No. D831,171



Brushed stainless steel	Brushed nickel	Brushed rose gold	Brushed vintage gold	Brushed classic gold
Item No.	Item No.	Item No.	Item No.	Item No.
KDIF4 GRK EB D6	KDIF4 GRK EBT D6	KDIF4 GRK EBRG D6	KDIF4 GRK EBVG D6	KDIF4 GRK EBCG D6



Cream	Greige	Stone grey	Bronze	Matte white	Matte black
Item No.	Item No.	Item No.	Item No.	Item No.	Item No.
KDIF4 GRK TSC D6	KDIF4 GRK TSBG D6	KDIF4 GRK TSSG D6	KDIF4 GRK TSOB D6	KDIF4 GRK MBW D6	KDIF4 GRK MGS D6

Floral

U.S. Patent No. D831,172



Brushed stainless steel	Brushed nickel	Brushed rose gold	Brushed vintage gold	Brushed classic gold
Item No.	Item No.	Item No.	Item No.	Item No.
KDIF4 GRK EBD5	KDIF4 GRK EBT D5	KDIF4 GRK EBRG D5	KDIF4 GRK EBVG D5	KDIF4 GRK EBCG D5



Cream	Greige	Stone grey	Bronze	Matte white	Matte black
Item No.	Item No.	Item No.	Item No.	Item No.	Item No.
KDIF4 GRK TSC D5	KDIF4 GRK TSBG D5	KDIF4 GRK TSSG D5	KDIF4 GRK TSOB D5	KDIF4 GRK MBW D5	KDIF4 GRK MGS D5

Stainless steel



Stainless steel
Item No.
KD4 GRK E



Chrome
Item No.
KD4 GRK EP



Oil-rubbed bronze
Item No.
KD4 GRK EOB



Nickel
Item No.
KD4 GRK ET



Rose gold
Item No.
KD4 GRK ERG



Vintage gold
Item No.
KD4 GRK EVG



Classic gold
Item No.
KD4 GRK ECG

Anodized aluminum



Brushed nickel anodized aluminum
Item No.
KD4 GRK ATGB



Brushed copper anodized aluminum
Item No.
KD4 GRK AKGB



Brushed brass anodized aluminum
Item No.
KD4 GRK AMGB

Contents



1x
Grate and frame



1x
Height adjustment collar



1x
Lateral adjustment ring

Schluter®-KERDI-DRAIN

GRATES FOR USE WITH FLANGES WITH 2" OUTLET

4" (100 mm) Grate

Tileable grate



Tileable grate
Item No.
KD4 GRK ECS

Patent pending

Contents		
 <p>1x Tileable covering support</p>	 <p>1x Spacer</p>	 <p>1x Lateral adjustment ring</p>

GRATES FOR USE WITH FLANGES WITH 2" or 3" OUTLET

6" (150 mm) Grate



Stainless steel



Stainless steel - 6" square
Item No.
KD6 GRK E











Stainless steel - 6" round
Item No.
KD6 GRK RE

Contents	
 <p>1x Grate and frame with integrated height adjustment collar</p>	 <p>1x Lateral adjustment ring</p>

Schluter®-KERDI-DRAIN









DRAIN KITS — ABS or PVC FLANGE - 2" OUTLET - STAINLESS STEEL GRATE

Schluter®-KERDI-DRAIN		
	ABS - 2" (50 mm)	PVC - 2" (50 mm)
4" (100 mm) square grate		
Stainless steel	KD2/ABS/E	KD2/PVC/E

Contents							
	1x Flange		1x Grate and frame		1x Height adjustment collar		1x Lateral adjustment ring
	4x Inside corners		2x Outside corners		1x Pipe seal (3/4" - 20 mm)		1x Mixing valve seal (4-1/2" - 114 mm)



ADAPTOR KIT — 5-1/4" ADAPTOR RING - 4" STAINLESS STEEL GRATE



5-1/4" (133.4 mm) adaptor ring	
	ABS
4" (100 mm) square grate	
Stainless steel	KDAR/ABS/E

Contents							
	1x Flange		1x Grate and frame		1x Height adjustment collar		1x Adaptor ring
	4x Inside corners		2x Outside corners		1x Pipe seal (3/4" - 20 mm)		1x Mixing valve seal (4-1/2" - 114 mm)
	1x KERDI-FIX sealing and bonding compound (3.38 oz - 100 ml)						

Schluter®-KERDI-DRAIN

ABS or PVC FLANGE — 2" or 3" OUTLET - WITHOUT SEALS AND CORNERS



2" (50 mm) drain outlet	
Material	Item No.
 ABS	KD2/ABS/FL
 PVC	KD2/PVC/FL

3" (75 mm) drain outlet	
Material	Item No.
 ABS	KD3/ABS/FL
 PVC	KD3/PVC/FL

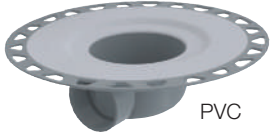
ABS or PVC HORIZONTAL FLANGE — 2" OUTLET - WITHOUT SEALS AND CORNERS

2" (50 mm) drain outlet	
Material	Item No.
 ABS	KDH2/ABS/FL
 PVC	KDH2/PVC/FL

STAINLESS STEEL FLANGE — 2" or 3" OUTLET - WITHOUT SEALS AND CORNERS

2" (50 mm) drain outlet	
Material	Item No.
 No-hub	KD2/E/FL
 Threaded	KD2/ETH/FL

3" (75 mm) drain outlet	
Material	Item No.
 No-hub	KD3/E/FL

Also included with stainless steel flanges

1x
KERDI-FIX
sealing and bonding compound (3.38 oz – 100 ml)









i

When using a flange with 3" outlet, a 6" grate is recommended.

Schluter®-KERDI-DRAIN

10 PACKS — ABS OR PVC FLANGE - 2" OUTLET





2" (50 mm) drain outlet	
Material	Item No.
 <p>ABS</p>	KD2 FLK ABS 10
 <p>PVC</p>	KD2 FLK PVC 10

Additional components included	
 <p>40x Inside corners</p>	 <p>20x Outside corners</p>
 <p>10x Pipe seal (3/4" - 20 mm)</p>	 <p>10x Mixing valve seal (4-1/2" - 114 mm)</p>

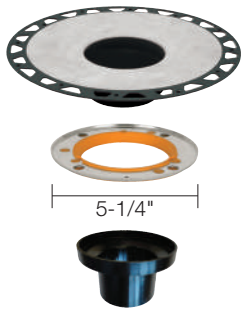
Note: 10 packs are packaged in bulk, not individually boxed.

10 PACKS — ABS FLANGE - 5-1/4" ADAPTOR RING

5-1/4" (133.4 mm) adaptor ring	
Flange and ring	Item No.
 <p>5-1/4"</p> <p>Also included: Height adjustment collar for KERDI-DRAIN grate</p>	KDA5 FLK ABS 10

Additional components included	
 <p>40x Inside corners</p>	 <p>20x Outside corners</p>
 <p>10x Pipe seal (3/4" - 20 mm)</p>	 <p>10x Mixing valve seal (4-1/2" - 114 mm)</p>
 <p>10x KERDI-FIX sealing and bonding compound (3.38 oz - 100 ml)</p>	

Note: 10 packs are packaged in bulk, not individually boxed.





The tileable grate and the 6" round/square grates are **NOT** compatible with the 5-1/4" ring flange.

10 PACKS — 4" GRATE - STAINLESS STEEL

Stainless steel



Stainless steel
Item No.
KD4 GRK E 10

Contents	
 <p>10x Grate and frame</p>	 <p>10x Height adjustment collar</p>
 <p>10x Lateral adjustment ring</p>	

Note: 10 packs are packaged in bulk, not individually boxed.

Schluter®-KERDI-DRAIN

6" SQUARE CLEAN OUT COVER

The **Schluter®-KERDI-DRAIN Clean Out Cover** is a 6" stainless steel cover available for installations where the KERDI-DRAIN bonding flange is to be used in a cleanout application.



Clean out cover 6"	
Item No.	Finish
KD-GR6C-E	Stainless steel

TAMPER PROOF SCREWS

Schluter®-KERDI-DRAIN Tamper Proof Screws are designed as a high security accessory for the KERDI-DRAIN. Ideal for loss prevention and anti-theft, these tamper proof screws are used in environments where tamper resistance is desired or required (e.g., healthcare or education facilities, etc.). Phillips head screws are included with the KERDI-DRAIN. The tamper-proof screws as well as the driver bit must be purchased separately.



Tamper proof screw and driver bit	
Item No.	Description
KD/TPSCRW	Tamper proof screw
KD/TPWRCH	Driver bit

STRAINER

The **Schluter®-KERDI-DRAIN Strainer** is a hair catcher customized to fit inside the KERDI-DRAIN flange to trap and collect hair. Simple to remove and clean, the hair catcher fits discreetly into the drain to prevent hair clogs that can lead to blocked pipes.



Strainer for KERDI-DRAIN	
Item No.	Description
KD-STR	Strainer



Note: There are multiple selections to be made for this product. Begin by selecting the appropriate channel body length then proceed to grate selection accordingly, keeping in mind there two frame height options for the perforated and closed-design grates.

Schluter®-KERDI-LINE

CHANNEL BODY

Contents

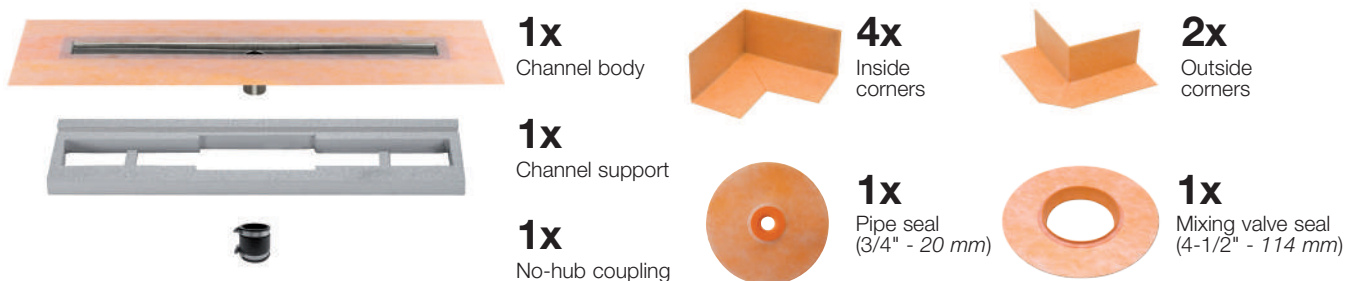

Channel body center outlet

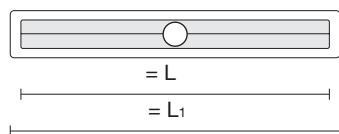

Schluter®-KERDI-LINE

Channel body - stainless steel - center outlet

L = in. - cm	L ₁ = in. - cm	Item No.
19-11/16 - 50	21-11/16 - 55	KL1V 60 E 50
23-5/8 - 60	25-5/8 - 65	KL1V 60 E 60
27-9/16 - 70	29-9/16 - 75	KL1V 60 E 70
31-1/2 - 80	33-1/2 - 85	KL1V 60 E 80
35-7/16 - 90	37-7/16 - 95	KL1V 60 E 90
39-3/8 - 100	41-3/8 - 105	KL1V 60 E 100
43-5/16 - 110	45-5/16 - 115	KL1V 60 E 110
47-1/4 - 120	49-1/4 - 125	KL1V 60 E 120
51-3/16 - 130	53-3/16 - 135	KL1V 60 E 130
55-1/8 - 140	57-1/8 - 145	KL1V 60 E 140
59-1/16 - 150	61-1/16 - 155	KL1V 60 E 150
62-15/16 - 160	64-15/16 - 165	KL1V 60 E 160
66-7/8 - 170	68-7/8 - 175	KL1V 60 E 170
70-13/16 - 180	72-13/16 - 185	KL1V 60 E 180

Channel body off-set outlet

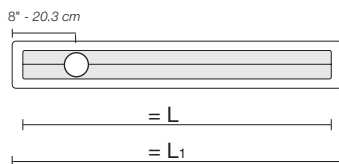

Channel body - stainless steel - off-set outlet

L = in. - cm	L ₁ = in. - cm	Item No.
27-9/16 - 70	29-9/16 - 75	KL1VO 60 E 70
31-1/2 - 80	33-1/2 - 85	KL1VO 60 E 80
35-7/16 - 90	37-7/16 - 95	KL1VO 60 E 90
39-3/8 - 100	41-3/8 - 105	KL1VO 60 E 100
43-5/16 - 110	45-5/16 - 115	KL1VO 60 E 110
47-1/4 - 120	49-1/4 - 125	KL1VO 60 E 120

Schluter®-KERDI-LINE

GRATE ASSEMBLY - BRUSHED STAINLESS STEEL

CONTENTS

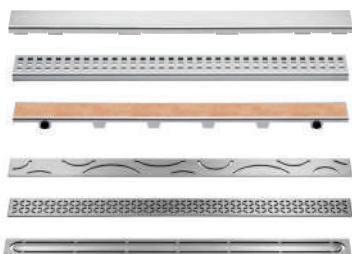

1x

- Grate
6 design options:
- Closed-design
 - Perforated
 - Frameless tileable
 - Curve
 - Floral
 - Pure



1x

Grate frame with height adjustment spacers. See product tables for frame height options (not included with frameless tileable grate).



Closed (A)

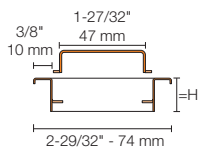

Perforated (B)

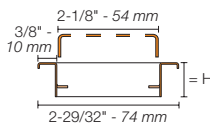

Grate assemblies - Brushed stainless steel



3/4" (19 mm) frame height for 1/8" to 9/16" (3 mm to 15 mm) -thick coverings

Length = in. - cm	Closed (A)	Perforated (B)
	Item No.	Item No.
19-11/16 - 50	KL1AR 19 EB 50	KL1B 19 EB 50
23-5/8 - 60	KL1AR 19 EB 60	KL1B 19 EB 60
27-9/16 - 70	KL1AR 19 EB 70	KL1B 19 EB 70
31-1/2 - 80	KL1AR 19 EB 80	KL1B 19 EB 80
35-7/16 - 90	KL1AR 19 EB 90	KL1B 19 EB 90
39-3/8 - 100	KL1AR 19 EB 100	KL1B 19 EB 100
43-5/16 - 110	KL1AR 19 EB 110	KL1B 19 EB 110
47-1/4 - 120	KL1AR 19 EB 120	KL1B 19 EB 120
51-3/16 - 130	KL1AR 19 EB 130	KL1B 19 EB 130
55-1/8 - 140	KL1AR 19 EB 140	KL1B 19 EB 140
59-1/16 - 150	KL1AR 19 EB 150	KL1B 19 EB 150
62-15/16 - 160	KL1AR 19 EB 160	KL1B 19 EB 160
66-7/8 - 170	KL1AR 19 EB 170	KL1B 19 EB 170
70-13/16 - 180	KL1AR 19 EB 180	KL1B 19 EB 180



1-1/8" (30 mm) frame height for 1/2" to 1" - (13 mm to 25 mm) -thick coverings

19-11/16 - 50	KL1AR 30 EB 50	KL1B 30 EB 50
23-5/8 - 60	KL1AR 30 EB 60	KL1B 30 EB 60
27-9/16 - 70	KL1AR 30 EB 70	KL1B 30 EB 70
31-1/2 - 80	KL1AR 30 EB 80	KL1B 30 EB 80
35-7/16 - 90	KL1AR 30 EB 90	KL1B 30 EB 90
39-3/8 - 100	KL1AR 30 EB 100	KL1B 30 EB 100
43-5/16 - 110	KL1AR 30 EB 110	KL1B 30 EB 110
47-1/4 - 120	KL1AR 30 EB 120	KL1B 30 EB 120

Schluter®-KERDI-LINE

GRATE ASSEMBLY - CHROME

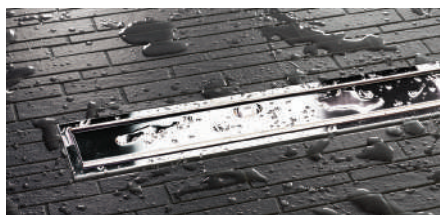

Closed (A)

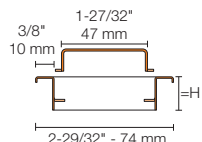

Perforated (B)

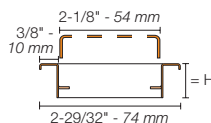

Grate assemblies - Chrome



3/4" (19 mm) frame height for 1/8" to 9/16" (3 mm to 15 mm) -thick coverings

Length = in. - cm	Closed (A)	Perforated (B)
	Item No.	Item No.
19-11/16 - 50	KL1AR 19 EP 50	KL1B 19 EP 50
23-5/8 - 60	KL1AR 19 EP 60	KL1B 19 EP 60
27-9/16 - 70	KL1AR 19 EP 70	KL1B 19 EP 70
31-1/2 - 80	KL1AR 19 EP 80	KL1B 19 EP 80
35-7/16 - 90	KL1AR 19 EP 90	KL1B 19 EP 90
39-3/8 - 100	KL1AR 19 EP 100	KL1B 19 EP 100
43-5/16 - 110	KL1AR 19 EP 110	KL1B 19 EP 110
47-1/4 - 120	KL1AR 19 EP 120	KL1B 19 EP 120



Frameless Tileable (D)

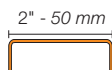

Grate assemblies - Frameless tileable

Length = in. - cm	Item No.	
	Frameless Tileable (D)	
	For use with center outlet channel body	For use with off-set outlet channel body
19-11/16 - 50	KL1DRE 50	-
23-5/8 - 60	KL1DRE 60	-
27-9/16 - 70	KL1DRE 70	KL1DRO E 70
31-1/2 - 80	KL1DRE 80	KL1DRO E 80
35-7/16 - 90	KL1DRE 90	KL1DRO E 90
39-3/8 - 100	KL1DRE 100	KL1DRO E 100
43-5/16 - 110	KL1DRE 110	KL1DRO E 110
47-1/4 - 120	KL1DRE 120	KL1DRO E 120
51-3/16 - 130	KL1DRE 130	-
55-1/8 - 140	KL1DRE 140	-
59-1/16 - 150	KL1DRE 150	-
62-15/16 - 160	KL1DRE 160	-
66-7/8 - 170	KL1DRE 170	-
70-13/16 - 180	KL1DRE 180	-

Schluter®-KERDI-LINE-STYLE

GRATE ASSEMBLY - BRUSHED STAINLESS STEEL STYLE DESIGNS

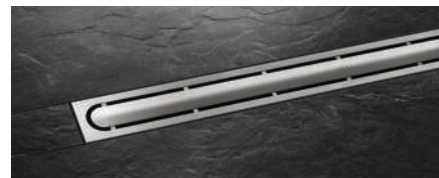
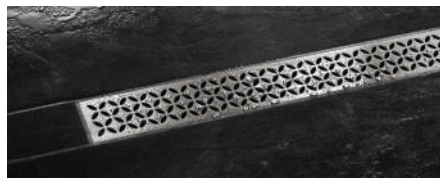

Curve

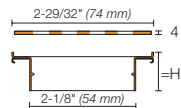

Floral

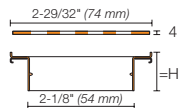

Pure

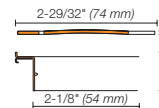

Grate assemblies - Brushed stainless steel



29/32" - 23 mm frame height for 1/4" - 11/16" (6 - 18 mm) -thick coverings

Length = in. - cm	Curve ¹	Floral ²	Pure ³
	Item No.	Item No.	Item No.
19-11/16 - 50	KL1IFF 23 EB 50	KL1IFE 23 EB 50	KL1IFG 23 EB 50
23-5/8 - 60	KL1IFF 23 EB 60	KL1IFE 23 EB 60	KL1IFG 23 EB 60
27-9/16 - 70	KL1IFF 23 EB 70	KL1IFE 23 EB 70	KL1IFG 23 EB 70
31-1/2 - 80	KL1IFF 23 EB 80	KL1IFE 23 EB 80	KL1IFG 23 EB 80
35-7/16 - 90	KL1IFF 23 EB 90	KL1IFE 23 EB 90	KL1IFG 23 EB 90
39-3/8 - 100	KL1IFF 23 EB 100	KL1IFE 23 EB 100	KL1IFG 23 EB 100
43-5/16 - 110	KL1IFF 23 EB 110	KL1IFE 23 EB 110	KL1IFG 23 EB 110
47-1/4 - 120	KL1IFF 23 EB 120	KL1IFE 23 EB 120	KL1IFG 23 EB 120

1. U.S. Patent No. D831,168 2. U.S. Patent No. D831,170 3. U.S. Patent No. D831,169

Schluter®-KERDI-LINE

PERFORATED GRATE WITH LOCKING MECHANISM

The **Schluter®-KERDI-LINE** perforated grate assembly (B) with 3/4" (19 mm) frame height is available with a locking mechanism for applications where tamper resistance is required.

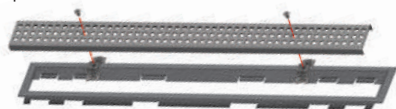

Perforated grate assembly with locking mechanism	
Length = in. - cm	Item No.
19-11/16 - 50	KL1BL 19 EB 50
23-5/8 - 60	KL1BL 19 EB 60
27-9/16 - 70	KL1BL 19 EB 70
31-1/2 - 80	KL1BL 19 EB 80
35-7/16 - 90	KL1BL 19 EB 90
39-3/8 - 100	KL1BL 19 EB 100
43-5/16 - 110	KL1BL 19 EB 110
47-1/4 - 120	KL1BL 19 EB 120
51-3/16 - 130	KL1BL 19 EB 130
55-1/8 - 140	KL1BL 19 EB 140
59-1/16 - 150	KL1BL 19 EB 150
62-15/16 - 160	KL1BL 19 EB 160
66-7/8 - 170	KL1BL 19 EB 170
70-13/16 - 180	KL1BL 19 EB 180

Note: Driver bit for tamper-proof screws sold separately. Please see page 125 in the Illustrated Price List.

COVER PLATE

Schluter®-KERDI-LINE-FC

Schluter®-KERDI-LINE-FC is a stainless steel cover plate for use with the Schluter®-KERDI-LINE linear floor drain to create a seamless look in applications where multiple drains are installed end to end. KERDI-LINE-FC is designed for use with either the solid or perforated grates.

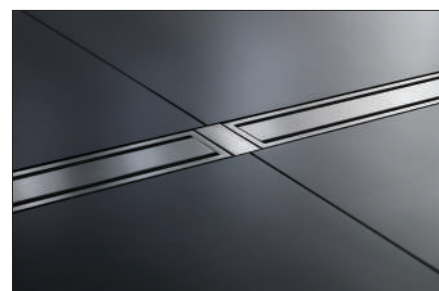
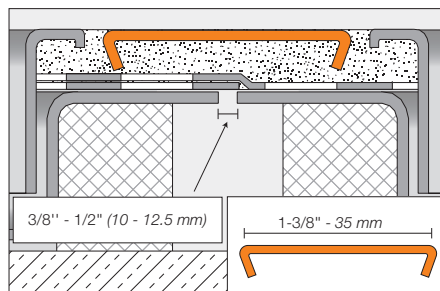
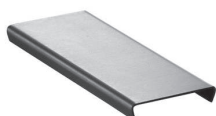

Schluter®-KERDI-LINE-FC Cover Plate	
Brushed stainless steel	Chrome
Item No.	Item No.
V / KLEB 35	V / KLEP 35

STRAINER

The **Schluter®-KERDI-LINE Strainer** is a hair catcher customized to fit inside the KERDI-LINE channel body to trap and collect hair. Simple to remove and clean, the hair catcher fits discreetly into the drain to prevent hair clogs that can lead to blocked pipes.



Strainer for KERDI-LINE	
Item No.	Description
KL VZ SF	Strainer

Product Listings and Certifications Table

Schluter®-KERDI-DRAIN - Listings and Certifications								
Grates Flanges	Grate - 4" (100 mm)					Grate - 6" (150 mm)		
	Design 1 Stainless steel (All finishes except EOB)	Design 1 Stainless steel EOB	Design 2 Anodized aluminum (All finishes)	Tileable	STYLE - Pure, Curve and Floral Stainless steel (All finishes)	Stainless steel		
						Square 6E	Round 6RE	Cover 6CE
2" PVC	1	-	1	1	1	1	1	2
2" ABS	1	-	1	1	1	1	1	2
2" PVC Horizontal	1	-	1	1	1	1	1	2
2" ABS Horizontal	1	-	1	1	1	1	1	2
2" Stainless steel	1	-	1	1	1	1	1	2
2" Stainless steel Threaded	1	-	1	1	1	1	1	2
3" PVC	-	-	-	-	-	1	1	2
3" ABS	-	-	-	-	-	1	1	2
3" Stainless steel	-	-	-	-	-	1	1	2
5-1/4" Adaptor	-	-	-	-	-	-	-	-
7-1/2" Adaptor	-	-	-	-	-	-	-	-

Schluter®-KERDI-LINE						
Bonding Flange	Grate					
	A	B	D	Floral (E)*	Curve (F)*	Pure (G)*
Center outlet - 19-11/16" - 47-1/4" (50 cm - 120 cm)	1	1	1	1	1	1
Center outlet - 51-3/16" - 70-13/16" (130 cm - 180 cm)	1	1	1	1	1	1
Off-set outlet - 27-9/16" - 47-1/4" (70 cm - 120 cm)	1	1	1	1	1	1

Various configurations of KERDI-DRAIN and KERDI-LINE are listed by ICC-ES (Report No. PMG-1204), UPC®, and CSA as shown in the table above.

1 - Listed by ICC-ES (Report No. PMG-1204), UPC®, and CSA.

2 - Listed by CSA

For copies of these documents, please contact Schluter®-Systems at 800-472-4588 (USA) or 800-667-8746 (Canada) or by email at info@schluter.com. Links to the documents can also be accessed at www.schluter.com.

Schluter®-Systems Floor Drains 10-Year Limited Warranty

COVERAGE AND CONDITIONS: Subject to the conditions and limitations as stated hereinafter, **Schluter®-Systems*** warrants that **Schluter®-KERDI-DRAIN** or **Schluter®-KERDI-LINE** (the "Product") will be free from manufacturing defects, and will not rot, deteriorate or break down under normal use for a period of ten (10) years from the date of purchase only when the Product is used and installed in accordance with the terms and conditions of the Schluter-Systems Floor Drains Technical Data Sheet and industry standard guidelines that are not in conflict with the Data Sheet in effect at the time of installation. It is the responsibility of the owner/ builder/ installer to ensure the suitability of all building materials and all associated building materials for the owner's intended use. It is recommended that the owner consult with an experienced and professional installer.

RESOLUTION: If the Product fails to meet this warranty, then the owner's exclusive remedy and the sole obligation of Schluter-Systems, at its election, shall be to a) replace the failed Product or b) pay an amount not to exceed the original cost of the Product verified to be defective. When Schluter-KERDI-DRAIN, Schluter-KERDI-DRAIN-H or Schluter-KERDI-LINE is installed in conjunction with Schluter®-DITRA or Schluter®-KERDI, the assembly qualifies for the Schluter-DITRA & Schluter®-DITRA-XL 10-Year Limited Warranty, Schluter-KERDI & Schluter-KERDI-DS 10-Year Limited Warranty, or Schluter®-Shower System 10-Year Limited Warranty. The warranties referenced above cover the entire covering assembly. Refer to the Schluter-DITRA Installation Handbook, Schluter®-Waterproofing Membranes Technical Data Sheet, and Schluter-Shower System Installation Handbook for details and applicable warranty information.

DISCLAIMER: There are no warranties beyond this expressed warranty as stated above. All other warranties, representations or conditions, expressed or implied, are disclaimed and excluded, including warranties, representations or conditions of **MERCHANTABILITY** or **FITNESS FOR A PARTICULAR PURPOSE** arising by statute or otherwise by law or from a course of dealing or usage of trade. Schluter-Systems excludes and in no event shall have any liability for lost profits or any other indirect, special, incidental, punitive, exemplary, or consequential damages, arising out of or otherwise connected to failure of the product or flooring system of which it is part, nor misuse of the product or flooring system, regardless of any strict liability, active or passive negligence of Schluter-Systems, and regardless of the legal theory (contract or tort or extra-contractual or other), nor from acts of war, terrorism, faulty and negligent penetration of the system, fires, explosions, acts of God, intentional acts of destruction or any losses due to structural failure or other causes unrelated to the product or delays, or any other incidental or consequential damages. This warranty is given in lieu of any other warranty expressed or implied. The remedies contained herein are the only remedies available for breach of this warranty. This limited warranty gives you specific legal rights; some states and provinces do not allow disclaimers or other restrictions of implied warranties, so some of the above disclaimers may not apply to you. **No changes or modification of any terms or conditions of this warranty are allowed unless authorized by written agreement and signed by the Technical Director or an Officer of Schluter-Systems.** For the most current information and materials regarding Schluter-Systems warranties and programs, please visit <https://www.schluter.com/downloadfiles>.

TRANSFERABILITY: This Limited Warranty extends ONLY to the original end user (defined as original intended owner and user of the property/unit in which the installation is incorporated - herein referred to as "Owner") and is not transferable or assignable, unless approved in writing by the Technical Director or an Officer of Schluter-Systems or otherwise prohibited by specific state or provincial law.

EFFECTIVE DATE: This warranty shall supersede and replace any and all prior oral or written warranties, agreements, or other such representations made by or on behalf of Schluter-Systems relative to the Product or the application of the Product and shall apply to any installation occurring on or after August 1, 2019.

CLAIMS ON THIS LIMITED WARRANTY: To make a claim under this Limited Warranty, the Owner must provide Schluter-Systems with written notice within 30 days of any alleged defect in the Product covered by this Limited Warranty, together with date and proof of purchase of the Product, proof of the costs of the original installation and name and address of all installers, failing which this Limited Warranty shall be of no legal effect. Schluter-Systems reserves the right at its election and as a condition of this Limited Warranty to inspect the alleged failed and defective condition.

All U.S. Claims shall be sent to:

Schluter Systems L.P.
Attn: Warranty Claims Dept.
194 Pleasant Ridge Road
Plattsburgh, NY 12901-5841

All Canadian Claims shall be sent to:

Schluter Systems (Canada), Inc.
Attn: Warranty Claims Dept.
21100 chemin Ste-Marie
Ste-Anne-de-Bellevue, QC H9X 3Y8

*For the purpose of this warranty **Schluter Systems, L.P.** shall provide the warranty for all products for end users located in the United States, and **Schluter Systems (Canada) Inc.** shall provide the warranty for all products for end users located in Canada. This warranty is limited to sales of the Product made in and intended for use in the United States and Canada.



Schluter Systems L.P. • 194 Pleasant Ridge Road, Plattsburgh, NY 12901-5841 • Tel.: 800-472-4588 • Fax: 800-477-9783
Schluter Systems (Canada) Inc. • 21100 chemin Ste-Marie, Ste-Anne-de-Bellevue, QC H9X 3Y8 • Tel.: 800-667-8746 • Fax: 877-667-2410

www.schluter.com

This technical data sheet is subject to change without notice. Please visit www.schluter.com for the latest version.