

**Top View**

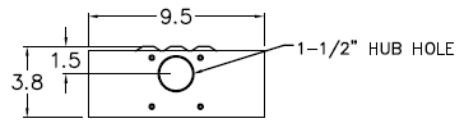

**Left Side View**

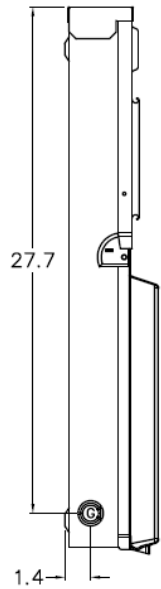

**Front View Interior**

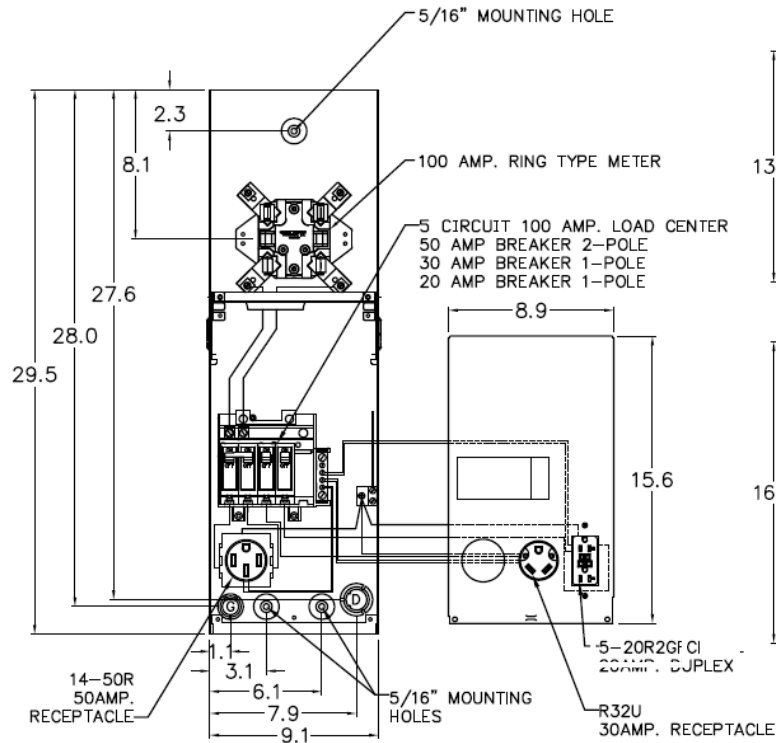

**Front View External Covers**

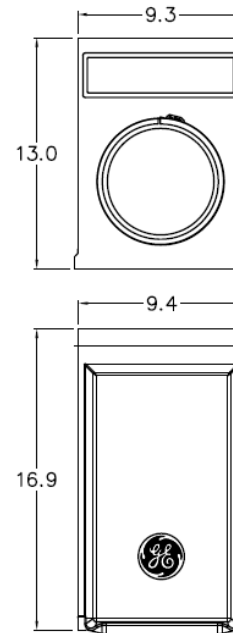

**Front Exterior View**

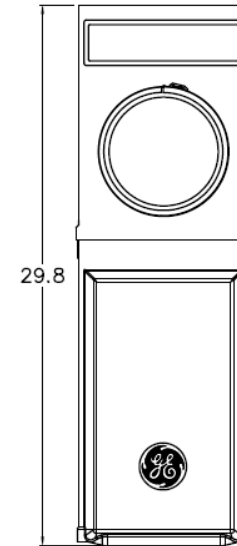

**Right Side View**

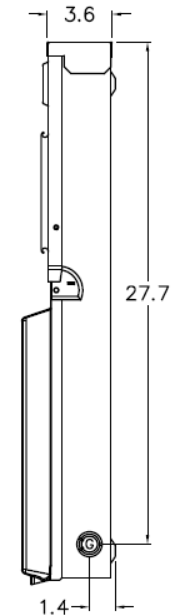

**Bottom View**

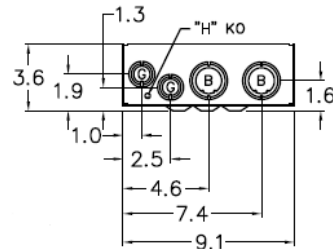

**Knockouts**

- G= 1/2", 3/4", 1" KO
- B= 1", 1-1/4", 1-1/2" KO
- D= 3/4", 1", 1-1/4" KO
- H= 9/32" KO

**Wire Range Size**

CONNECTOR	COPPER		ALUMINUM	
	SOLID	STRAND	SOLID	STRAND
LINE	---	6-1/0	---	6-1/0
LOAD	14-10	14-10	---	---
NEUTRAL	LARGE HOLE 12-8	12-1/0	10-8	10-1/0
NEUTRAL	SMALL HOLE 14-8	14-4	12-8	12-4
EQUIP. GRND.	12-8	12-2	12-8	12-2



imagination at work

GE RV EQUIP-100A-MLO-RING TYPE-50A,30A&20A  
RECEPT-SURFACE-SINGLE SIDED-UNLIGHTED-G90-N3R

CAT NO	DWG DATE	REV #
GE1LM532SS	05/13/2016	01