

# BAYOU CLASSIC®

MODEL  
#SP1

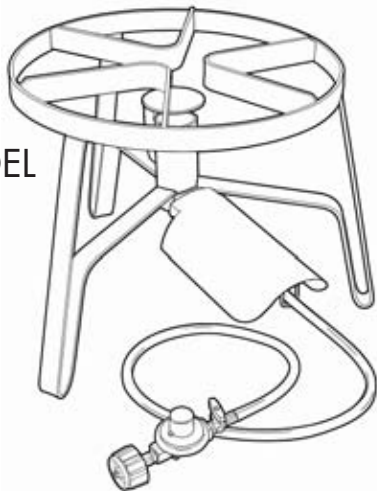

MODEL  
#SP10

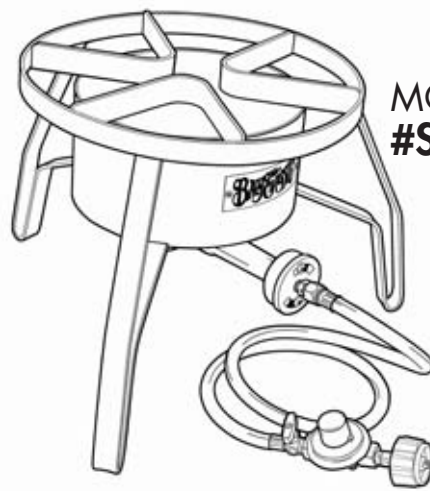

## LP GAS COOKER

# OWNER'S MANUAL

**SAFETY ALERTS, ASSEMBLY & OPERATING INSTRUCTIONS  
GENERAL MAINTENANCE & STORAGE**

This Instruction Manual contains important information necessary for the proper assembly and safe use of this appliance. You must carefully read and follow all warnings and instructions in this manual before assembling and using this appliance.

**KEEP THIS MANUAL FOR FUTURE REFERENCE**

### **⚠ WARNING ⚠**

- The maximum size cooking vessel for frying with this cooker using oil/grease is 36-quart. The maximum size cooking vessel for boiling or steaming with this cooker is 100-quart.
- Do not use a cooking vessel smaller than 12-inches diameter.

**NOT FOR COMMERCIAL USE**

For Questions and Information call us at: **1-800-864-6194** • Monday - Friday 8:00am - 5:00pm CST  
Barbour International, Inc. • 101 Cypress Way • Brandon, MS 39042 • [www.thebayou.com](http://www.thebayou.com)

# CONTENTS

Warnings & Dangers	1 - 8	Operating Instructions	19
Assembly Instructions	9	Test Your Thermometer and Placement	20 - 21
LP Gas Cylinder Specifications	10 - 11	How to Determine Proper Amount of Liquid <b>for Boiling, Steaming or Frying</b>	21 - 22
Regulator Hose Assembly	12	Boiling Instructions	22 - 23
Connecting Regulator Hose Assembly to Cooker	12	Steaming Instructions	24
Connecting Regulator Hose Assembly to LP Gas Cylinder	13	Frying Instructions	24 - 26
Gas Leak Testing	13 - 14	Cooking Oil: Important Facts to Know	26 - 27
Pre-Cooking Check List & Positioning the Cooker	15	-----	
<b>Model #SP10 Cooker</b>		<b>Model #SP10 Cooker</b>	
Lighting Instructions	16	Trouble Shooting Tips	28
Burner Flame Check and How to Re-ignite Burner	17	Trouble Shooting Guide	29
Turning off Cooker and Disconnecting Hose	17	-----	
<b>Model #SP1 Jet Cooker</b>		<b>Model #SP1 Jet Cooker</b>	
Lighting Instructions	18	Trouble Shooting Tips	30
Burner Flame Check and How to Re-ignite Burner	19	Trouble Shooting Guide	31
Turning off Cooker and Disconnecting Hose	19	General Maintenance and Storage	32
		Care and use Instructions for Cookware	33

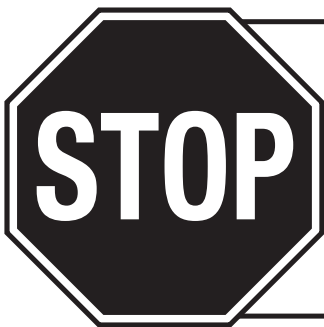

If you have a missing or damaged part, **please do not return** this item to the store.

Call **Barbour International, Inc.** for assistance:

**1-800-864-6194**

**Monday-Friday 8:00am - 5:00pm CST**

## LIMITED WARRANTY

Barbour International, Inc. ("Vendor") warrants to the original retail purchaser of this gas fryer/cooker and no other person, that if this gas fryer/cooker is assembled and operated in accordance with the printed instructions accompanying it, then for a period of one (1) year from the date of purchase, all parts in such gas fryer/cooker shall be free from defects in material and workmanship. Vendor may require reasonable proof of your date of purchase from an authorized retailer or distributor. Therefore, you should retain your sales slip or invoice. This Limited Warranty shall be limited to the repair or replacement of parts, which prove defective under normal use and service and which Vendor shall determine in its reasonable discretion upon examination to be defective. Before returning any parts, you should contact Vendor's Customer Service Department using the contact information listed below. If Vendor confirms, after examination, a defect covered by this Limited Warranty in any returned part, and if Vendor approves the claim, Vendor will replace such defective part without charge. If you return defective parts, transportation charges must be prepaid by you. Vendor will return replacement parts to the original retail purchaser, freight or postage prepaid.

This Limited Warranty does not cover any failures or operating difficulties due to accident, abuse, misuse, alteration, misapplication, improper installation or improper maintenance or service by you or any third party, or failure to perform normal and routine maintenance on the gas fryer/cooker, as set out in this owner's manual. In addition, the Limited Warranty does not cover damage to the finish, such as scratches, surface chips and cracks, discoloration, rust or other weather damage, after purchase.

This Limited Warranty is in lieu of all other express warranties. Vendor disclaims all warranties for products that are purchased from sellers other than authorized retailers or distributors. AFTER THE PERIOD OF THE ONE (1)-YEAR EXPRESS WARRANTY, VENDOR DISCLAIMS ANY AND ALL IMPLIED WARRANTIES, INCLUDING WITHOUT LIMITATION THE IMPLIED WARRANTIES OF MERCHANTABILITY AND FITNESS FOR A PARTICULAR PURPOSE. FURTHER, VENDOR SHALL HAVE NO LIABILITY WHATSOEVER TO PURCHASER OR ANY THIRD PARTY FOR ANY SPECIAL, INDIRECT, PUNITIVE, INCIDENTAL, OR CONSEQUENTIAL DAMAGES. Vendor assumes no responsibility for any defects caused by third parties. This Limited Warranty gives the purchaser specific legal rights; a purchaser may have other rights depending upon where he or she lives. Some jurisdictions do not allow the exclusion or limitation of special, incidental or consequential damages, or limitations on how long a warranty lasts, so the above exclusion and limitations may apply to you.

Vendor does not authorize any person or company to assume for it any other obligation or liability in connection with the sale, installation, use, removal, return, or replacement of its equipment, and no such representations are binding on Vendor.

## NOTE TO CONSUMER

This LP Gas Cooker is a specialized high pressure gas appliance having greater heat output than traditional kitchen stoves. It is referred to as **cooker** and **appliance** in this manual and on warning tags. Same as a kitchen stove, this cooker does not have automatic thermostat controls so must be attended and monitored at all times during use.

This LP Gas Cooker is for **OUTDOOR USE ONLY!**

**Do not use a cooking vessel larger than 100-quart for boiling or 36-quart for frying on this cooker.**

**Do not use a cooking vessel smaller than 12" diameter on this cooker.**

This cooker provides multiple cooking options such as frying fish, chicken, french fries, hushpuppies, wings and onions. You can also use this cooker to cook soups, stews and gumbo; boil or steam seafood, crawfish and vegetables.

As with any cooking appliance, care must be taken to follow all Safety Precautions and Instructions in order to achieve safe and satisfactory cooking results.



Restrict the use of this appliance to adults who can read, understand and follow the warnings and instructions in this manual, and on the cooker. Safety Alerts alone cannot eliminate the hazards that they signal. Strict compliance with these instructions, plus common sense operation, are primary accident prevention measures.



## SAFETY SYMBOLS



The symbols and boxes shown below explain what each heading means. Read and follow all of the safety warnings and instructions contained in this manual and on the cooker.

**THE PURPOSE OF THIS SAFETY ALERT SYMBOL  IS TO ATTRACT YOUR ATTENTION TO POSSIBLE HAZARDS AS YOU ASSEMBLE AND USE THIS PRODUCT.**

**WHEN YOU SEE THE SAFETY ALERT SYMBOL  PAY CLOSE ATTENTION TO THE INFORMATION WHICH FOLLOWS!**

** DANGER ** → Indicates an imminently hazardous situation which, if not avoided, will result in death or serious injury.

** WARNING ** → Hazard or unsafe practices which could result in severe property damages, personal injury, or death.

** CAUTION ** → Hazard or unsafe practices which could result in minor personal injury, product, or property damages.

Carefully read and follow all **WARNINGS, SAFETY PRECAUTIONS, ASSEMBLY and OPERATING INSTRUCTIONS** contained in this manual and on the cooker.

**DO NOT skip any of the warnings and instructions! SAVE THIS MANUAL FOR FUTURE REFERENCE.**

### **WARNING FOR YOUR SAFETY:**

**For Outdoor Use Only** (outside any enclosure)

- 1. Improper installation, adjustment, alteration, service or maintenance can cause injury or property damage.**
- 2. Read the installation, operation, and maintenance instructions thoroughly before installing or servicing this equipment.**
- 3. Failure to follow these instructions could result in fire or explosion, which could cause property damage, personal injury, or death.**

# SAFETY PRECAUTIONS AND WARNINGS

## ! WARNING !

**This cooker does not have automatic thermostat controls. Failure to follow these instructions could result in fire or explosion which could cause property damage, personal injury or death!**



### **ALWAYS**

operate in an open area a minimum of 10-ft from buildings, trees and overhangs.



### **OUTDOOR USE ONLY!**

Do not operate inside garages, carports or patios.



### **NEVER LEAVE COOKER UNATTENDED!**



### **NEVER**

use under any roof or overhang.



### **NEVER**

use on decks, boats or any combustible surface!



### **NEVER**

place flammable or combustible materials within 25-ft of cooker.



### **NEVER**

cover pot with lid when preheating oil or frying.



### **NEVER!**

allow children or pets near the cooking area during and after use.



### **NEVER!**

No barefeet or sandals when cooking.



### **HOT!**

Extremely hot during and after use. Allow appliance to cool below 115°F (45°C) before cleaning or storing



### **ALWAYS**

wear protective mitts, gloves, goggles and long sleeve clothing when cooking.



### **ALWAYS**

use an accurate thermometer to monitor temperature when preheating oil or frying.

**Remember: Think Safety and Use Common Sense!**

## **⚠ WARNING ⚠**

- This cooker is a high pressure gas appliance for **OUTDOOR USE ONLY**.
- This cooker does not have automatic thermostat controls so must be attended and monitored at all times during use.
- If having any doubts or concerns about your ability to use this product call 800-864-6194.
- Should you still have concerns about operating this product, then do not use. Contact your dealer for return and refund.
- The warnings and safety instructions in this manual **MUST** be followed to provide reasonable safety and efficiency in using the appliance.

**Remember; Think Safety and Use Common Sense!**

## **⚠ DANGER ⚠**

### **IF YOU SMELL GAS:**

1. Shut off gas to the appliance.
2. Extinguish any open flame.
3. If odor continues, keep away from the appliance and immediately call your fire department.

**LEAKING GAS MAY CAUSE A FIRE OR EXPLOSION WHICH COULD CAUSE PROPERTY DAMAGE, PERSONAL INJURY OR DEATH.**

## **⚠ DANGER ⚠**

- Never operate this appliance unattended. A sober, adult must attend and monitor this appliance at all times during use.
- Never operate this appliance within 10 feet (3.0m) of any structure, combustible material or other gas cylinder.
- Never operate this appliance within 25 feet (7.5m) of any flammable liquids.
- Never allow oil or grease to get hotter than 400°F (200°C). If the temperature exceeds 400°F (200°C) or if oil begins to smoke, immediately turn the burner or gas supply OFF.
- Heated liquids remain at scalding temperatures long after the cooking process. Never touch the cooking appliance until liquids have cooled to 115°F (45°C) or less.
- If a fire should occur, keep away from the appliance and immediately call your local Fire Department. Do not attempt to extinguish an oil or grease fire with water.
- Be cautious when in close proximity to any gas appliance. Falling or tripping near the appliance, or over an appliance hose, may result in the spilling or igniting of oil or splashing of boiling water, potentially causing personal injury and property damage.

**FAILURE TO FOLLOW INSTRUCTIONS CONTAINED IN THIS OWNER'S MANUAL COULD RESULT IN FIRE, EXPLOSION OR BURN HAZARD, WHICH COULD CAUSE PROPERTY DAMAGE, PERSONAL INJURY OR DEATH.**

# ⚠ WARNING ⚠

## COOKING WITH OIL OR GREASE

- This cooker does not have automatic thermostat controls so must be attended and monitored at all times during oil heat up and frying.
- For frying with this cooker, do not use a cooking vessel larger than 36-quart or smaller than 12 inches diameter.
- When cooking with oil/grease, a thermometer must be used. Follow instructions in this manual for proper testing, installation and use of your frying thermometer.
- Follow instructions contained in this manual for proper assembly and positioning of the cooker, gas leak and thermometer test, determining proper amount of oil to use, heat-up and frying operation, cleanup and storage.
- Cooking oil pre-heat up to over-heat times can vary significantly with relatively small adjustments to regulator; variable wind, ambient temperature, altitude, starting oil temperature, and type of cooking oil used.
- Do not allow cooking oil/grease to exceed 400°F (200°C) which is the FIRE HAZARD zone on the thermometer. Cooking oil/grease will ignite and catch fire at 550°F to 700°F (287°C to 371°C).
- Due to varying heating and cooking times, check your thermometer every 3 minutes to ensure cooking oil does not exceed 400°F (200°C). This is an ATTENDED appliance. DO NOT leave appliance unattended while heating oil/grease, cooking food or cool down period after use.
- This cooker can heat 3 quarts of cooking oil/grease to 350°F (175°C) in 3 to 5 minutes.
- DO NOT use a lid when pre-heating or cooking with oil. Using a lid when frying greatly increases the potential of over-heating the oil to ignition and fire.
- Smoking oil is an indication that the oil is too hot and may ignite. Regardless of thermometer reading, if the oil/grease starts to smoke, turn OFF fuel supply to the burner and STOP COOKING IMMEDIATELY. This indicates the thermometer is not working properly. Discard the thermometer and call **1-800-864-6194 M-F 8am - 5pm CST for assistance.**  
**Replacement thermometer Model #5020 or #5025.**
- Never overfill the cooking vessel with oil/grease or water. Follow instructions in this manual for establishing proper liquid levels for cooking.
- When frying with oil or grease, all food products MUST be completely thawed and towel dried to remove excess water. Failure to completely thaw and dry foods may cause oil or grease to overflow from cooking vessel. If ice is present on the food, it means the thawing process is not complete and may cause a boil over when placed into HOT oil causing a fire and severe burns.
- Never drop food or accessories into hot liquids. Wear protective gloves and S-L-O-W-L-Y lower food and accessories into cooking oil in order to prevent splashing or overflow. Be careful when removing food from oil. It is hot and could cause burns.
- In the event of rain, snow, hail, sleet or other form of precipitation while cooking with oil, cover the cooking vessel and immediately turn off the burner and gas supply. DO NOT MOVE cooker or cooking vessel.
- When cooking with oil/grease, have a BC or ABC type fire extinguisher readily accessible.
- The cooking vessel remains at scalding temperatures long after cooking has ended. Allow appliance to cool below 115°F (45°C) before cleaning or storing. Cool down period varies with amount of oil/grease used, wind and ambient temperature.

## ⚠ DANGER ⚠

### IF OIL OR GREASE FIRE OCCURS

In the event of an oil/grease fire, do not attempt to extinguish with water. Immediately call your local Fire Department. A Type BC or ABC dry chemical fire extinguisher may in some cases contain the fire.

If a fire occurs **INSIDE THE COOKING VESSEL** follow these steps.

- Turn off gas supply.
- Wearing a protective glove, cover the pot with a lid. DO NOT re-open lid as the oil/grease fire could re-ignite. Allow cooking vessel to cool down to 115°F (45°C) before opening lid.

If a fire occurs **OUTSIDE THE COOKING VESSEL** follow these steps.

- Turn off the gas supply if possible.
- Wearing a protective glove, cover the pot with a lid if possible.
- Call the local Fire Department if property damage is possible.
- Attempt to extinguish using a chemical fire extinguisher specified.
- Once fire is extinguished, DO NOT re-open lid as the oil/grease fire could re-ignite. Allow cooking vessel to cool down to 115°F (45°C) before opening lid.

## ⚠ WARNING ⚠



**A. DO NOT store a spare LP cylinder under or near a gas cooker appliance.**

**B. Never fill the cylinder beyond 80% full.**

**C. If the information in (A) and (B) are not followed exactly, a fire causing death or serious injury may occur.**

## ⚠ WARNING ⚠

### PLACEMENT OF COOKER

- **This cooker shall be used OUTDOORS ONLY.** DO NOT use in a building, home, garage, balcony, porch, tent or any other enclosed area. Gas cookers shall not be used on or under apartment, condominium balcony or deck. DO NOT install or use in or on recreational vehicles and/or boats.
- DO NOT operate this Gas Cooker closer than 10 feet (3m) from any combustible materials including walls or railing, or under overhead construction and tree branches as these materials could ignite should oil/grease fire occur.
- The cooker must be positioned on a level, stable, noncombustible surface such as brick, concrete or dirt. Do not position cooker on wood, asphalt or plastic which may burn, blister or melt.
- Do not use on combustible flooring or surfaces such as wooden decks.
- Keep the cooking area clear and free of any combustible material such as household chemicals, paint, gasoline and other flammable vapors and liquids. Do not store or use gasoline or other liquid/aerosols with flammable vapors within 25 feet (7.5m) of this cooker.
- Prior to lighting the burner, check wind direction for placement of cooker **DOWNWIND** from upright LP cylinder. The cooker must be **DOWNWIND** and least 20" away from LP cylinder to keep heat away from cylinder.
- **Refer to instructions for Proper Positioning of the Cooker on page 15 in this manual.**

## ⚠️ WARNING ⚠️

### THERMOMETER & OIL TEMPERATURE

- This gas appliance does not have automatic thermostat controls so must be **attended** and **monitored** at all times during use.
- When cooking with oil or grease, a thermometer **MUST** be used for reasonable temperature reading. Follow instructions for **proper testing, installation and use of a thermometer on pages 20 -21 in this manual.**
- Test your thermometer before each use. If your thermometer does not function properly, a replacement thermometer must be obtained before frying with this cooker.
- Carefully monitor the temperature of cooking oil with your thermometer and regulate temperature so it does not reach the "Fire Hazard" zone on your thermometer. If necessary, turn the gas OFF to the cooker to allow the oil to cool.
- Oil ignites at varying temperatures depending on type of oil used, altitude, ambient temperature and wind. Check your thermometer every 3 minutes to ensure cooking oil does not exceed 400°F (200°C).
- Do not allow oil or grease to exceed 400°F (200°C). Oil or grease will ignite and catch fire at 550°F to 700°F (287°C to 371°C). If cooking oil or grease reaches 400°F (200°C), turn burner OFF. Wait for the cooking oil or grease temperature to decrease to less than 350°F (117°C) before relighting burner.
- Regardless of thermometer reading, if the oil/grease starts to smoke, turn OFF fuel supply to the burner and **STOP COOKING IMMEDIATELY**. This indicates the thermometer is not working properly. Discard the thermometer and call **1-800-864-6194 M-F 8am - 5pm CST for assistance.**  
**Replacement thermometer Model #5020 or #5025.**

## ⚠️ WARNING ⚠️

### REGULATOR HOSE ASSEMBLY

- The pressure regulator hose assembly supplied with this cooker must be used. Clean and inspect the hose before each use of the cooker. If there is evidence of abrasion, wear, cuts or leaks, the hose must be replaced prior to the cooker being put into operation. Only use replacement regulator hose assembly #M5HPR-1.

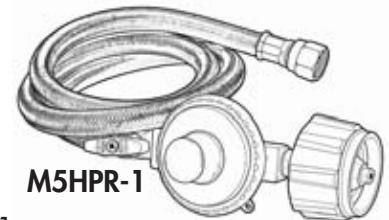

M5HPR-1

**This part can be obtained by contacting Barbour International, Inc. at 1-800-864-6194.**

Replace regulator hose assembly at least every two years. Keep the fuel supply hose away from any heated surface.

- Refer to instructions for connecting regulator hose assembly to LP gas cylinder and burner in this manual.
- Check all gas connections by following the Gas Leak Testing Instructions on pages 13 -14 in this manual. Never test for gas leaks with a lighted match or open flame. **DO NOT** operate this cooker with a gas leak.
- Follow **Lighting Instructions** as stated in this manual. Use a fireplace match or gas appliance butane lighter.
- **The valve on regulator hose assembly controls flame intensity only. It is not an ON/OFF valve.**



## **WARNING**

### **LP GAS CYLINDER**

- Use only a 20 pound LP Gas Cylinder or smaller with a protective collar.
- LP (propane) gas is colorless, tasteless, heavier than air, and is both flammable and explosive. Combustion of propane consumes oxygen and produces carbon monoxide, a poisonous gas. Therefore, never operate an outdoor cooker appliance inside a building or confined area where ventilation may be restricted. Make sure the LP cylinder and the cooker are placed in an open area. DO NOT obstruct the flow of combustion and ventilation air.
- Never use a gas cylinder if it shows signs of dents, gouges, bulges, fire damage, erosion, leakage, excessive rust, or other forms of visible external damage. The cylinder may be hazardous and should be checked by a qualified liquid propane supplier.
- Never attach a gas cylinder, move or alter fittings while cooker is hot or in operation.
- Do not attempt to disconnect the regulator hose assembly while cooker is in operation.
- When cooker use is complete, always turn the LP cylinder valve OFF first, then turn the regulator control valve OFF. Turning the cylinder OFF first allows remaining gas to flow out of the regulator hose assembly before the regulator control valve is turned OFF.
- DO NOT use external electrical sources with this appliance.
- Storage of this appliance indoors is permissible only if the cylinder is disconnected and removed from the appliance and left outdoors. Cylinders must be stored outdoors out of the reach of children and must not be stored in a building, garage or any other enclosed area.
- The installation of this appliance must conform with local codes or, in the absence of local codes, with the National Fuel Gas Code, ANSI Z223.1/NFPA 54, Storage and Handling of Liquefied Petroleum Gases, ANSI/NFPA 58, Natural Gas and Propane Installation Code, CSA B149.1, Propane Storage and Handling, CSA B149.2, or the Standard for Recreational Vehicles, ANSI A119.2/NFPA 1192 and the Recreational Vehicle Code, CSA z240 RV Series.
- **Refer to section about LP Gas Cylinder Information on pages 10 -11 in this manual.**

## **WARNING**

### **GENERAL OPERATING**

- This appliance does not have automatic thermostat controls so must be attended and monitored at all times during use.
- Use only the regulator hose assembly that is supplied with this appliance, **Model #M5HPR-1**.
- This appliance has an open flame. In sunlight or other bright light, the flame may be almost invisible. Use extreme caution keeping hands, hair and clothing away from the cooker. Do not lean over the cooker when lighting burner. Loose hair and clothing can catch fire during lighting and operation.
- This is an ATTENDED appliance, DO NOT leave this appliance unattended while heating oil, grease or water, cooking food or when hot after use (oil, grease or water above 115°F: 45°C). Heated liquid can remain at scalding temperatures long after cooking has ended.
- When cooking with oil/grease, a thermometer must be used to monitor temperature. Oil/grease heated above 400°F (200°C) will ignite and catch fire causing property damage, personal injury or death.

# ⚠ WARNING ⚠

## GENERAL OPERATING - CONTINUED

- Even when burner is set at a low flame, never leave the cooker unattended. Cooking oil/grease will heat up quickly and ignite at 550°F to 700°F (287°C to 371°C).
- Keep children and pets away from the cooking area at all times. Carefully monitor all activity around cooker to avoid burns or other injuries.
- This appliance will be hot during and after use. Use insulated oven mitts or gloves for protection from hot surfaces or splatter from cooking liquids. Always wear closed toe shoes while cooking with this appliance.
- Use caution when walking or standing near cooker as splattered oil may have created a slick surface. Do not walk between cooker and propane tank as this creates a trip hazard. Tripping over the hose could overturn the cooker.
- Avoid bumping of or impact with the appliance to prevent spillage or splashing of hot cooking liquid which can cause severe burns.
- DO NOT move the appliance when in use. Allow cooking vessel to cool down to 115°F (45°C) before moving, cleaning or storing.
- Should the burner flame go out during use, turn all gas valves off. Wait 5 minutes for gas to evacuate before re-lighting. See instructions in this manual for correct procedures.
- Never overfill a cooking vessel with oil, grease or water. Overfilled cooking vessels can boil over and cause a fire. Follow instructions in this manual for establishing proper oil or water level.
- After a period of storage or nonuse, check this appliance for gas leaks and burner obstructions before use. See instructions in this manual for correct procedures.
- Sober adult operation ONLY! Read and understand this manual before using this appliance. The use of alcohol, prescription or nonprescription drugs may impair ability to properly assemble or safely operate this appliance.
- DO NOT place an empty cooking vessel on the cooker while in operation as it could melt. Use caution when placing anything in a cooking vessel while the appliance is in operation.
- Children can fall into cooking vessel and drown in even a small amount of liquid. Keep cooking vessel out of reach of children. Do not store your cooking vessel with liquid inside.
- When cooking with oil/grease, have a Type BC or ABC fire extinguisher readily accessible.
- This appliance is not intended for and should never be used as a heater.
- Do not use this cooker for other than its intended purpose.
- Combustion by-products from the use of this product contain chemicals known to the State of California to cause cancer, birth defects, or other reproductive harm.
- Never use glassware, plastic, or ceramic cookware on this appliance.
- Only use replacement/accessory parts manufactured by Barbour International, Inc. Repairs should be performed by Barbour International, Inc.
- **If you see, smell or hear the hiss of escaping gas from the liquid propane cylinder.**
  1. Move away from liquid propane cylinder.
  2. Do not attempt to correct the problem yourself.
  3. Call your fire department.

# ASSEMBLY INSTRUCTIONS

READ ALL SAFETY WARNINGS & ASSEMBLY INSTRUCTIONS CAREFULLY BEFORE ASSEMBLING OR OPERATING YOUR COOKER. Inspect contents in the box to ensure all parts are included and undamaged.

**FOR MISSING PARTS OR ASSISTANCE, PLEASE CALL 1-800-864-6194 M-F 8am - 5pm CST.**

Proof of purchase will be required.

## Model #SP1 Jet Cooker

### TOOLS REQUIRED:



Adjustable Wrench



Hex Wrench, provided

### PARTS INCLUDED:



1- Frame



1- Regulator  
Hose Assembly



1- Hose Guard



1 - Hex Bolt



1 - Nut

1. Remove components from the box and packing.
2. **Attach Hose to Orifice Bar** - Screw Hose on to end of Orifice Bar. Wrench tighten.

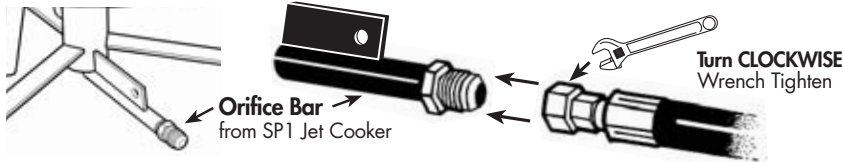

Refer to Connecting Regulator Hose Assembly to Cooker on page 12.

3. **Attach Hose Guard to Cooker** - Line up hole on Hose Guard with hole on Support Bar. Attach using Hex Bolt and Nut. Use Wrench to tighten.

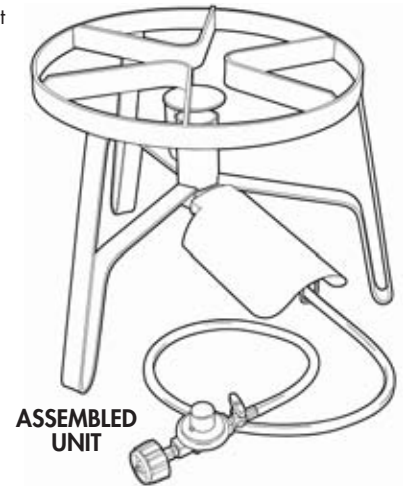

ASSEMBLED UNIT

## Model #SP10 Cooker

### TOOLS REQUIRED:



Adjustable Wrench

### PARTS INCLUDED:

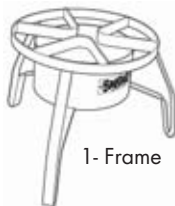

1- Frame



1- Regulator  
Hose Assembly

**NOTE: BG10 Burner may have Air Shutter attached with screws instead of using a Spring.**



1 - BG10 Burner  
with Locking Nut



1- Air Shutter



1- Spring

1. Remove components from the box and packing.
2. **Attach Burner to Crossbar** - Remove locking nut from bottom of burner. Line up burner bolt to hole in crossbar. Insert the bolt through the crossbar and screw on locking nut. Wrench tighten.

3. **Attach Hose to Burner** - In one of two ways as shown below:

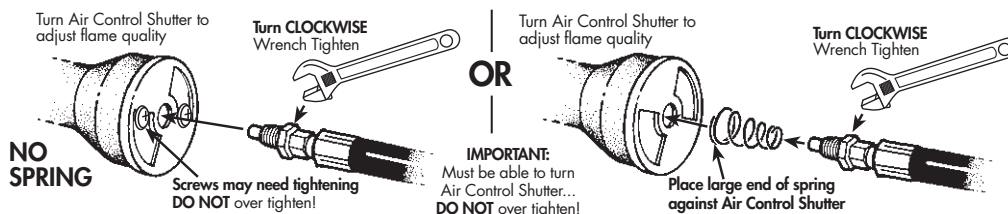

Refer to Connecting Regulator Hose Assembly to Cooker on page 12.

**NOTE: Do not over tighten brass hose connector to burner.** The air control shutter must be able to easily turn for adjustment of flame quality. If you over tighten the brass hose connector to the burner and the air shutter cannot turn, then unscrew the brass hose connector until the shutter can be easily turned... **Very Important!**

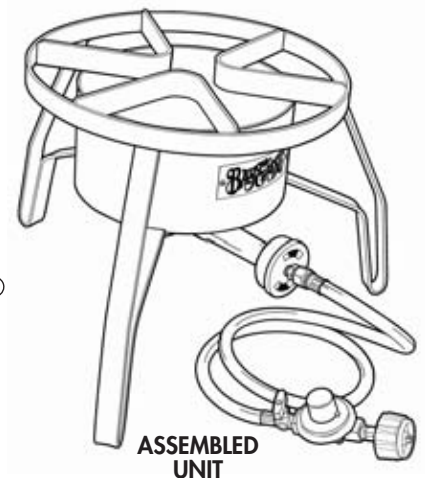

ASSEMBLED UNIT

# LP GAS CYLINDER SPECIFICATIONS

**! DANGER !**



## CARBON MONOXIDE HAZARD

This appliance can produce carbon monoxide which has no odor.

Using it in an enclosed space can kill you.

Never use this appliance in an enclosed space such as a camper, tent, car or home.

**! WARNING !**

### LP GAS CYLINDER (NOT SUPPLIED WITH THIS COOKER)

The LP (Liquid Propane) gas cylinder specifically designed to be used with this cooker must have a 20 lb (9.1 kg) capacity incorporating a Type-1 cylinder valve and an over-filling protection device (OPD).

- DO NOT connect this cooker to an existing #510 POL cylinder valve with Left Hand Threads. The Type-1 valve can be identified with the large external threads on the valve outlet.
- DO NOT connect to a propane cylinder exceeding this capacity.
- DO NOT connect to a cylinder that uses any other type of valve connection device.

## LP GAS CYLINDER

To check your local codes, see your local LP gas dealer or natural gas company. This cooker is not intended to be connected to a natural gas supply line.

When purchasing or exchanging a cylinder for your gas cooker, it must be constructed and marked in accordance with the specifications for LP gas cylinders by the U.S. Department of Transportation (DOT) or the National Standard of Canada, CAN/CSA-B339, Cylinders, Spheres and Tubes for the Transportation of Dangerous Goods as applicable with a listed over-filling device (OPD).

### The cylinder must also be equipped with:

- A shut-off valve terminating in a Type-1 gas cylinder valve outlet.
- A Type-1 valve that prevents gas flow until a positive seal is obtained.
- An arrangement for vapor withdrawal.
- A collar to protect the cylinder shut-off valve.
- A safety relief device having direct communication with the vapor space of the cylinder.
- A listed Over-filling Prevention Device (OPD).
- A protective cap on cylinder Type-1 Outlet.

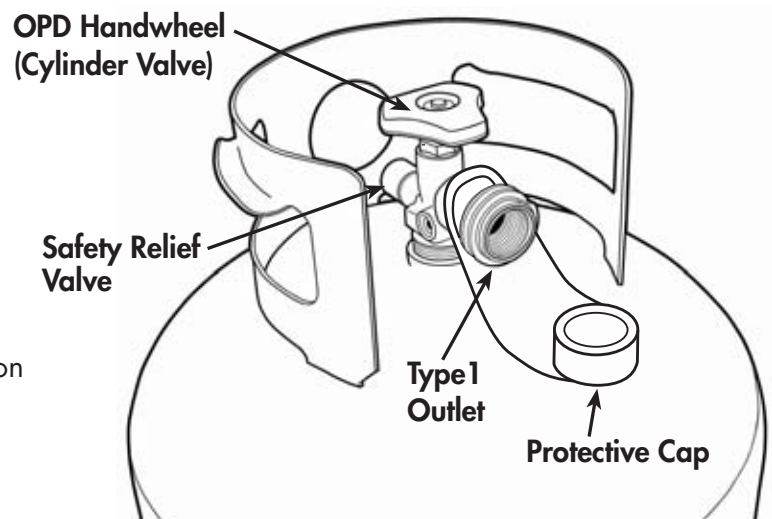

## ⚠️ WARNING ⚠️

- Turn off the cylinder valve when your cooker is not in use.
- Handle the LP gas cylinder with care.
- Always secure the LP gas cylinder in an upright position.
- Never connect an unregulated LP gas cylinder to your cooker.
- DO NOT expose LP gas cylinders to excessive heat or ignition sources.
- DO NOT store a spare LP gas cylinder near your cooker.
- Allow only qualified LP gas dealers to fill or repair your LP gas cylinder
- DO NOT allow the LP gas cylinder to be filled beyond 80% capacity.
- Read and follow all warnings/instructions that are on the cylinder and that accompany this product.

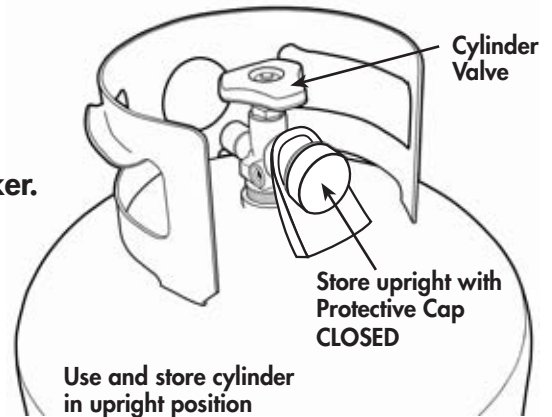

## ⚠️ DANGER ⚠️

- Never store spare LP gas cylinder near your cooker. This could cause excess pressure to be expelled through the vapor relief valve resulting in fire, explosion, or severe personal injury, including death.
- NOTE: PROPANE GAS IS HEAVIER THAN AIR AND WILL COLLECT IN LOW AREAS. PROPER VENTILATION IS EXTREMELY IMPORTANT**
- Keep the ventilation opening(s) of the LP gas cylinder enclosure free and clear from obstruction and debris.
  - DO NOT insert any foreign objects into the valve outlet. Damage to the back-check could result. A damaged back-check can cause a leak, possibly resulting in explosion, fire, severe personal injury, bodily harm or death.

## ⚠️ WARNING ⚠️

### FILLING THE LP GAS CYLINDER:

- Allow only qualified LP gas dealers to properly fill or repair your LP gas cylinder.
- New tanks should be purged prior to filling; inform LP gas dealer if you are using a new tank.
- DO NOT allow the cylinder to be filled beyond 80% capacity. Over-filled tanks can create a dangerous condition. Over-filled tanks can build up pressure and cause the relief valve to expel propane gas vapors. The vapor is combustible and if it comes in contact with a spark source or flame; an explosion causing severe burns, bodily harm, or death could occur.
- Always use a protective cylinder cap when cooker is not connected to cylinder.
- If you exchange a cylinder with a qualified exchange program, be sure the cylinder has a Type-1 valve and an over-filling prevention device (OPD).

# REGULATOR HOSE ASSEMBLY

Your cooker is equipped with a Type-1 connection device with the following features:

1. The system will not allow gas flow from the cylinder until a **positive connection** to the cylinder valve has been made.

**NOTE:** The cylinder valve must be turned off (clockwise) before any connection is made or removed.

2. A **flow limiting device**, when activated, restricts the flow of gas to 10 cubic feet per hour.

**NOTE:** the flow limiting device is a safety feature that can be activated when attempting to light the cooker. If this occurs, refer to **Trouble Shooting** on pages 28-31 for proper remedy.

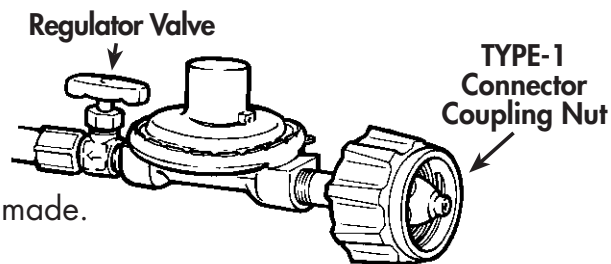

For connection to LP Gas Cylinder

## ⚠ WARNING ⚠

The pressure regulator and hose assembly supplied with your gas cooker is designed to work with an LP gas supply cylinder.

- DO NOT attempt to connect it to any other fuel supply source such as a natural gas line.
- DO NOT use any other pressure regulator/hose assembly than the one supplied with your cooker.
- DO NOT attempt to adjust or repair the regulator. A replacement regulator can be supplied by contacting Barbour International, Inc. at 1-800-864-6194. The regulator is designed to operate at a maximum output pressure of 10 psi (pounds per square inch).
- Never use your cooker without leak testing all gas connections, regulator hose assembly and weld seams on propane tank. See the section on "Gas Leak Testing" in this manual for proper procedures.

## CONNECTING REGULATOR HOSE ASSEMBLY TO COOKER

The Regulator Hose Assembly is a pre-assembled unit. Do not take apart. Simply connect the regulator hose assembly to the LP gas cylinder and to the cooker. An adjustable wrench is needed when attaching the hose to the **SP10 Burner or SP1 Orifice Bar**.

Visually inspect the regulator hose assembly prior to each use. If there is evidence of abrasion, wear, cuts or leaks, the hose must be replaced prior to the appliance being put into operation.

Call 1-800-864-6194 for replacement Model #M5HPR-1. M-F 8am - 5pm CST.

### #SP10 Cooker - Attach hose connector to burner in one of two ways as shown below.

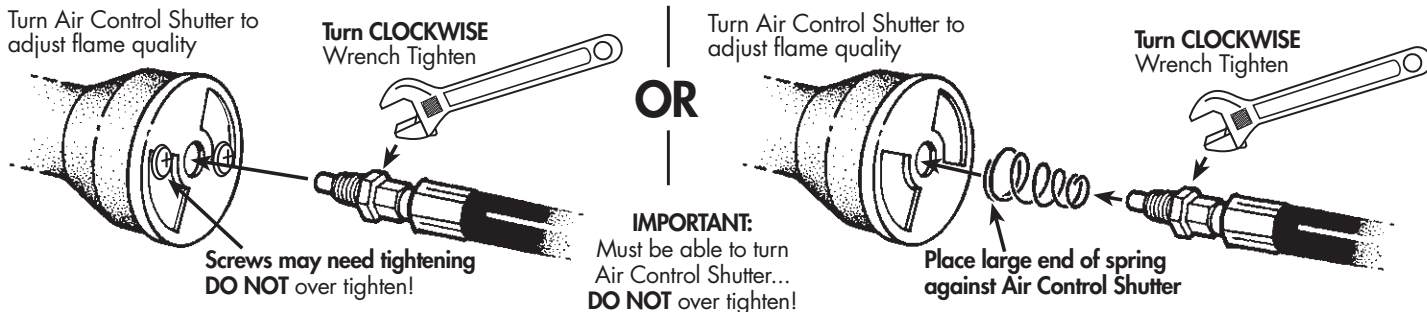

### #SP1 Jet Cooker - Attach hose connector to orifice bar as shown below.

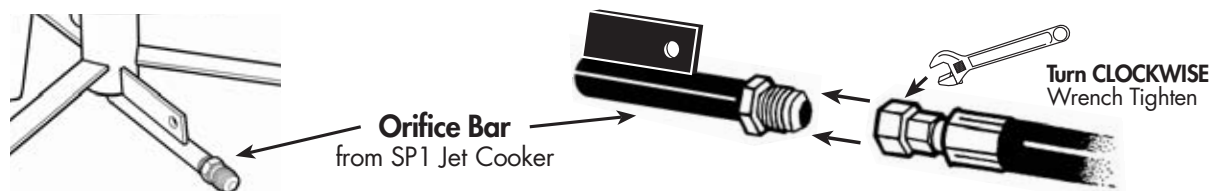

## ⚠️ WARNING ⚠️

Insure the cylinder valve is **CLOSED** (valve turned clockwise) prior to connecting the LP gas cylinder to your cooker. Turn brass valve on the regulator clockwise to properly close the flow of gas. Read and follow all instructions and warnings on the supply hose safety tags. Read and follow all warnings in this manual concerning the safe use of LP gas cylinders and the regulator hose assembly, before connecting cylinder to cooker. Read and follow all warnings on the LP gas cylinder.

## CONNECTING REGULATOR HOSE ASSEMBLY TO LP GAS CYLINDER

1. Check that cylinder is upright and the valve is closed by turning the knob clockwise.
2. Remove the protective safety cap from the cylinder valve and the Type-1 Coupling Nut on the regulator
3. Insert the nipple of the large coupling nut into cylinder valve outlet. Insure that the coupling nut is centered properly.
4. Turn the large coupling nut clockwise by hand and tighten to a full stop. Take care not to cross thread the coupling nut onto the cylinder valve. Do not use tools to tighten connection.

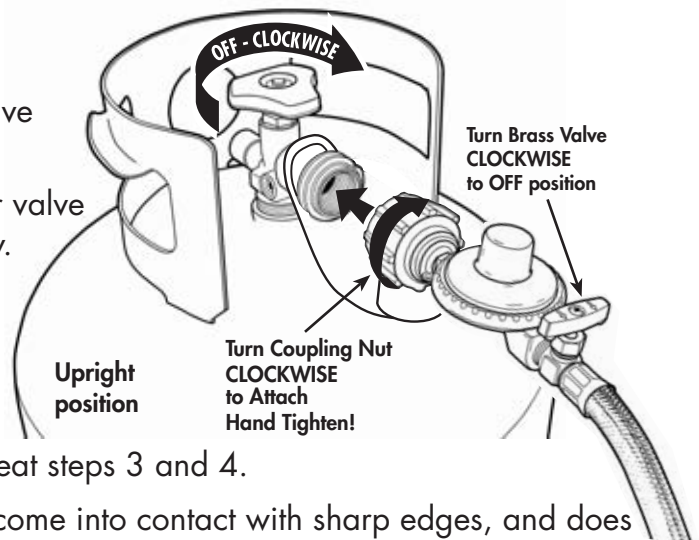

**NOTE:** If you are unable to make the connection, repeat steps 3 and 4.

5. Check that the hose does not contain kinks, does not come into contact with sharp edges, and does not contact surfaces that may become hot during use.
6. Leak check all fittings before lighting cooker. See section on "Gas Leak Test Instructions" on pages 13-14.

## GAS LEAK TESTING

### ⚠️ DANGER ⚠️

#### LEAK TESTING

To prevent fire or explosion hazard:

- **DO NOT** smoke or permit ignition sources in the area while conducting a leak test.
- Perform test **OUTDOORS** only in a well ventilated area at least 10-ft. away from any structure or trees.
- Never perform a leak test with a match or open flame.
- Never perform a leak test while the cooker is in use or while cooker is still hot.

### ⚠️ WARNING ⚠️

#### WHEN TO PERFORM A LEAK TEST

- After assembling your cooker and before lighting for the first time, even if purchased fully assembled.
- Every time the LP gas cylinder is refilled or if any of the gas components are replaced.
- Any time your cooker has been moved.
- At least once per year or if your cooker has not been used for more than 60 days.

# GAS LEAK TEST INSTRUCTIONS

**Note:** The gas leak test must be performed in an area that has adequate lighting in order to see if bubbles are developing.

**DO NOT** use a flashlight to check for bubbles.

1. Create a mixture of 50% water and 50% liquid dishwashing soap.
2. Turn the gas cylinder valve to the OFF position (clockwise). Then turn regulator valve to OFF position (clockwise).
3. To turn ON the fuel supply, turn the cylinder valve knob one turn counter-clockwise. Gas will flow through and stop at the closed regulator valve.
4. Using a clean brush, apply the soap water mixture to the following:

- A** Cylinder Valve to Cylinder
- B** Connection Nut to Cylinder Valve
- C** Back side of Connection Nut to Brass Nipple
- D** Brass Valve next to Regulator
- E** Regulator connection to Gas Supply Hose
- F** LP Cylinder Welds
- G** Full length of Gas Supply Hose
- H** Gas Supply Hose connection to Burner

5. Check each place **A - F** for growing bubbles which indicates a leak.
6. Next, turn ON regulator valve (counter-clockwise) to permit gas to pass through the hose. Apply soap water mixture to full length of gas supply hose and connection to burner assembly. Check each place for growing bubbles, **G & H**, which indicates a leak.
7. Turn OFF gas supply valve (clockwise) on LP Gas Cylinder.
8. Turn regulator valve to OFF position (clockwise).
9. Tighten any leaking connections.
10. Repeat soap water mixture test until no leaks are detected.

**DO NOT** use cooker if gas leaks cannot be stopped.

**Call 1-800-864-6194 M-F 8am - 5pm CST for assistance, or contact a qualified appliance repair service.**

11. After you are certain there are no leaks, turn tank valve and regulator valve to OFF position. Wait 5 minutes for any gas fumes to evacuate before lighting the burner.

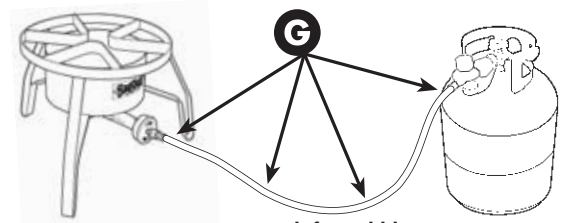
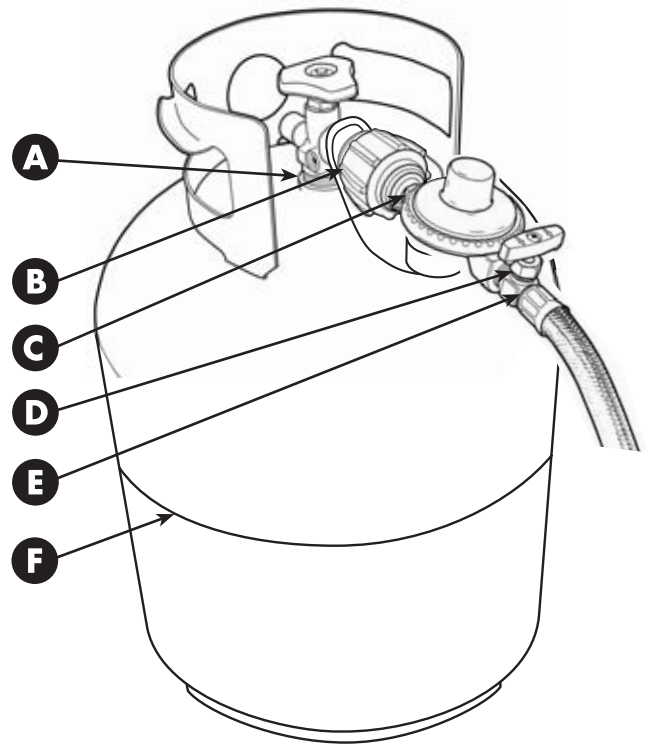

Watch for Bubbles

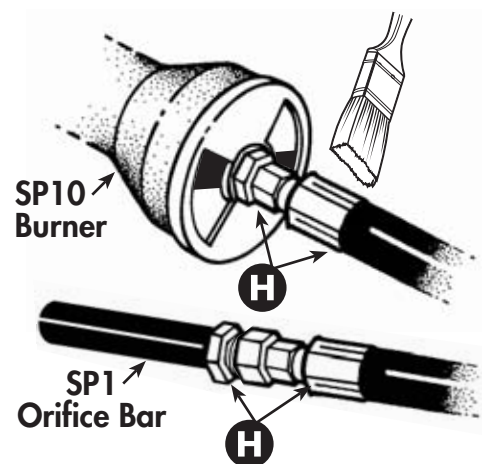

## ⚠️ WARNING ⚠️

**If growing soap bubbles persist throughout any portion of the Gas Leak Test, terminate use immediately. For assistance, contact your propane dealer or Barbour International, Inc. at 1-800-864-6194.**



## PRE-COOKING CHECK LIST

### ⚠ WARNING ⚠

**DO NOT** operate this cooker until you have read and understand **ALL** of the warnings and instructions in this manual. Property damage, bodily harm, severe burns and death could result from failure to follow these safety steps. These steps should be performed after the cooker has been assembled, stored, moved, cleaned, or repaired.

1. Insure that the cooker is properly assembled and connected to propane cylinder.
2. Position the cooker on level ground in a well ventilated location, a safe distance from combustible materials, buildings and overhangs. Propane cylinder should be positioned upwind from cooker so the heat of cooker does not reach cylinder. See section below on this page for **Positioning the Cooker**.
3. Inspect the gas supply hose for burns, chaffing, kinks and proper routing before each use. Hose should be positioned at least 3 inches away from hot surfaces.
4. Leak check all gas connections on regulator hose assembly, LP cylinder valve and weld seams. See section on **Gas Leak Testing** on pages 13-14.
5. Insure that all electrical supply cords are properly grounded and are kept away from this appliance, water and hot surfaces. **DO NOT** use external electrical sources with this appliance.
6. When frying, test your cooking thermometer to insure that it is working properly. See section for **Thermometer Testing and Placement** on pages 20-21.
7. Determine proper amount of cooking liquid to use. See section for **Proper Amount of Liquid** on pages 21-22.
8. Follow Lighting Instructions. See sections for **Lighting Instructions**.
9. **Read, understand and follow all cooker operating instructions and steam, boil, frying instructions.**

## POSITIONING THE COOKER

1. Check wind direction.
2. Position cooker **DOWNWIND** from the nearest structure; no closer than 10-ft from nearest building or railing, keeping flames from any potential oil/grease fire away from nearest structure.
3. Position cooker **DOWNWIND** from the LP Gas Cylinder keeping a minimum distance of 20" apart so the heat of the cooker does not reach cylinder.
4. Position cooker on level ground in a well ventilated location, a safe distance from combustible materials, rails, buildings, overhangs or tree branches.

↑ **Make sure overhead is clear of combustible materials!** ↑

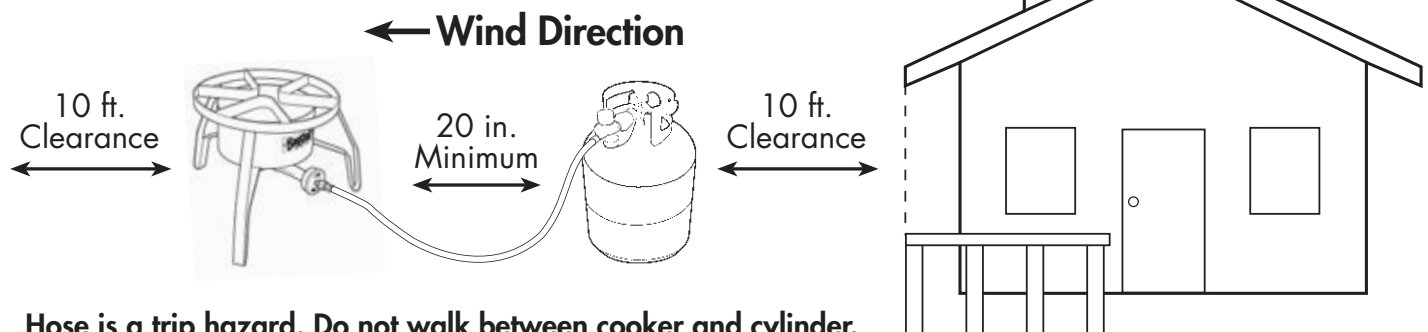

**Hose is a trip hazard. Do not walk between cooker and cylinder.**

5. Check that gas supply hose does not contact surfaces that may become hot during use.

# Model #SP10 Cooker - LIGHTING INSTRUCTIONS

## ⚠ WARNING ⚠ FOR YOUR SAFETY:

DO NOT stand with head, body or arms over the cooker when lighting. Loose clothing and hair can catch fire during lighting and operation.

Follow these instructions exactly. Read and follow all warnings and instructions in this manual before using your cooker.

1. Make sure regulator valve and cylinder valve are in the OFF position.
2. Turn ON the fuel supply by S-L-O-W-L-Y rotating the cylinder valve counter-clockwise **one full turn**. **HINT: Turning the cylinder valve quickly causes a sudden rush of gas that sometimes activates the Gas Flow Limiting Device. To prevent this, always rotate cylinder valve S-L-O-W-L-Y.**
3. Place fire place match or long lighter over the burner, then S-L-O-W-L-Y turn regulator valve counter-clockwise until you hear gas HISSING to the burner. Then light the burner, keeping hands and face away from the top of the cooker.
4. Adjust air control shutter on burner for a blue flame. In direct sunlight, flame may appear clear.
5. Adjust the regulator valve for desired flame height.
6. After lighting, rotate cylinder valve to full open.

### BEFORE LIGHTING

Make sure LP Cylinder is OFF

Make sure Regulator Valve is OFF

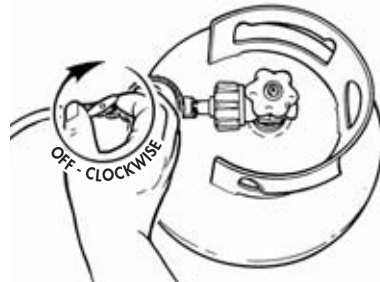
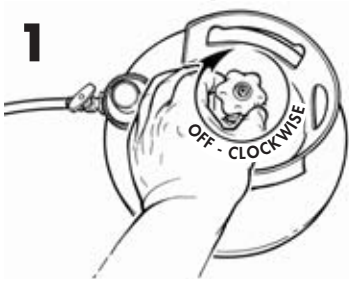

S-L-O-W-L-Y Turn LP Cylinder Valve One Full Turn counter-clockwise

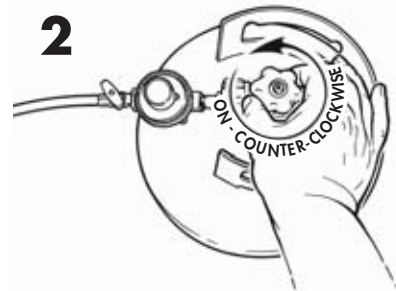

Gas will flow to and stop at closed regulator

### LIGHTING

Place lit Match over Burner

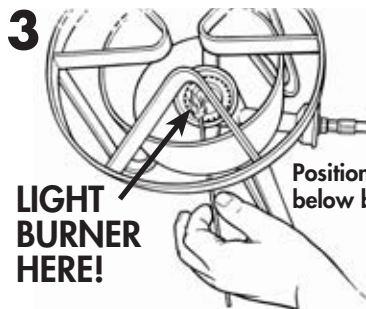

Position hand below burner

S-L-O-W-L-Y Turn Regulator Valve ON counter-clockwise

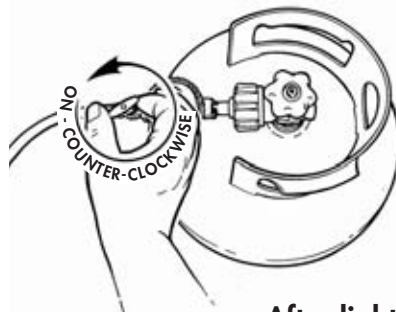

ADJUST Air Control Shutter for Blue Flame



ADJUST Regulator Valve for Flame Height

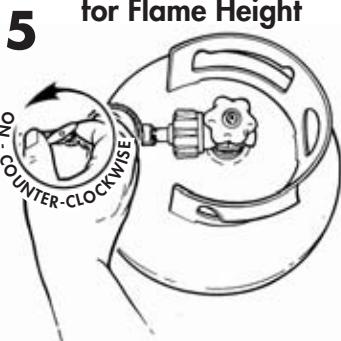

**NOTE:** The brass valve on regulator hose assembly controls flame intensity only. It is not an ON/OFF valve.

After lighting Burner, OPEN LP Cylinder Valve FULLY

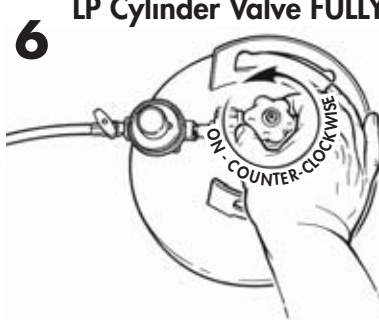

### ⚠ WARNING ⚠

DO NOT light burner at air intake

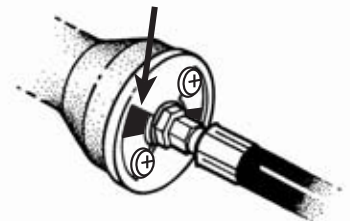

## Model #SP10 Cooker - BURNER FLAME CHECK

Adjust flame height using regulator valve. Rotate air control shutter to achieve mostly blue flame. The air control shutter mounted on the front of burner helps to control the amount of air that mixes with the LP gas. A blue flame with little or no yellow flame indicates a proper air/gas mixture and provides the best heat. Adjust the air control shutter until the desired flame is achieved.

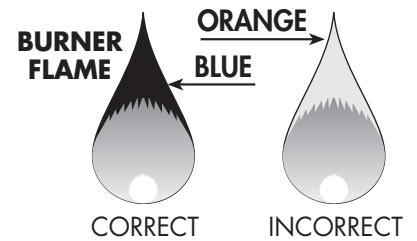

**NOTE:** Make sure the brass fitting on hose is screwed into the burner/air shutter and tightened securely. Do not over-tighten as the air shutter needs to move freely in order to adjust air intake. Check the attachment for proper connection everytime propane tank is connected to cooker.

**HINT:** Before lighting, turn air control shutter on the burner to an almost closed position. This increases the gas portion of the air/gas mixture and makes the burner easier to light. After lighting, turn air control shutter to an open position to achieve a better flame.

When lighting for the first time, you will smell paint burning at the top of the cooker for a few minutes... This is normal.

If burner flame does NOT ignite immediately, or is accidentally extinguished, turn LP Gas Cylinder Valve clockwise to OFF. Then turn regulator valve clockwise to OFF position. Wait 5 minutes for gas to evacuate before re-lighting, then repeat steps 1-6 to re-light. Always use caution when re-lighting as cooker frame and cooking vessel will be hot.

If the burner does not light within the first few attempts, there is a problem with the gas supply. Turn off the gas at the cylinder and regulator. **DO NOT** attempt to operate the cooker until the problem is found and corrected. Refer to Troubleshooting on Pages 28 - 29.

## HOW TO REIGNITE Model #SP10 BURNER

Follow steps 1 - 6 on previous page, to reignite burner. Use caution when re-lighting the burner, as hot oil from cooking vessel may have splattered and run down the sides of the unit creating a slick surface. Use caution not to bump the cooker or cooking vessel when re-lighting the burner.

## TURNING OFF COOKER AND DISCONNECTING HOSE FOR Model #SP10

**NOTE:** Turn off LP gas cylinder valve first to prevent gas from being left in the regulator hose system under pressure.

1. Turn OFF the LP gas cylinder valve **clockwise** until it stops.
2. Turn regulator valve to the OFF position, **clockwise** until it stops.
3. To disconnect Regulator Hose Assembly, turn the large coupling nut **counter-clockwise** by hand.

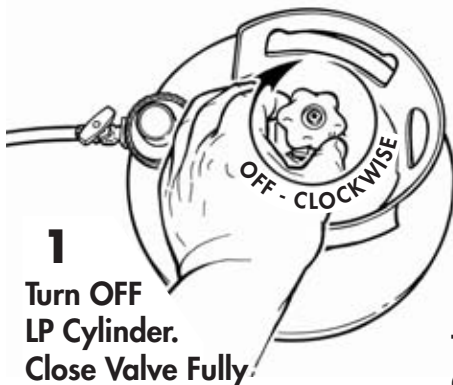

**1**  
Turn OFF  
LP Cylinder.  
Close Valve Fully.

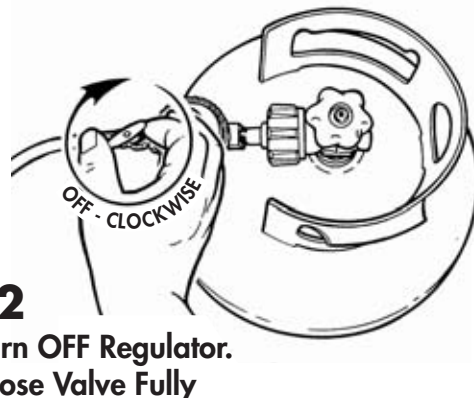

**2**  
Turn OFF Regulator.  
Close Valve Fully

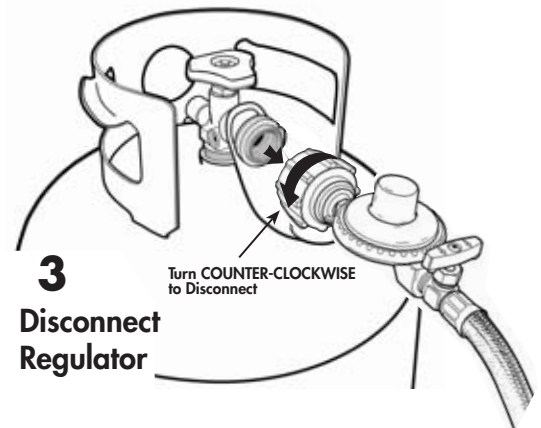

**3**  
Disconnect  
Regulator

### ⚠ WARNING ⚠

The LP gas cylinder valve should always be in the OFF or closed position when the cooker is not in use.

# Model #SP1 JET COOKER - LIGHTING INSTRUCTIONS

## ⚠ WARNING ⚠ FOR YOUR SAFETY:

DO NOT stand with head, body or arms over the cooker when lighting. Loose clothing and hair can catch fire during lighting and operation.

Follow these instructions exactly. Read and follow all warnings and instructions in this manual before using your cooker.

1. Make sure regulator valve and cylinder valve are in the OFF position.
2. Look into the jet tube to be certain that orifice hole in brass cap is facing straight up. If needed, use a wrench to turn the brass cap so that the orifice hole is facing straight up.
3. Make certain that Flame Spreader is in open position.
4. Turn ON the fuel supply by S-L-O-W-L-Y rotating the cylinder valve counter-clockwise **one full turn**. **HINT: Turning the cylinder valve quickly causes a sudden rush of gas that sometimes activates the Gas Flow Limiting Device. To prevent this, always rotate cylinder valve S-L-O-W-L-Y.**
5. Place fire place match or long lighter over the jet tube, then S-L-O-W-L-Y turn regulator valve clockwise until you hear gas HISSING to the burner. Then light the cooker, keeping hands and face away from the top of the jet tube. In direct sunlight, flame may appear clear.
6. Adjust the regulator valve for desired flame height.
7. After lighting, rotate cylinder valve to full open.

### BEFORE LIGHTING

Make sure LP Cylinder is OFF

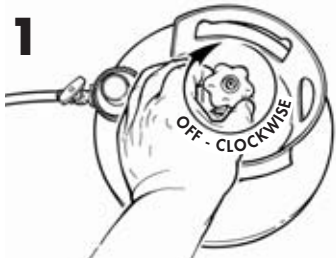

Make sure Regulator Valve is OFF

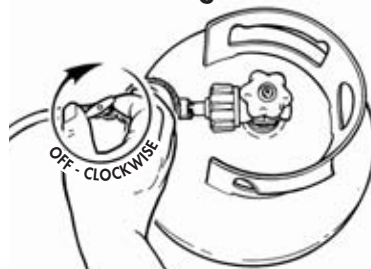

2 & 3

Make sure Jet Tube is clean, orifice hole facing straight up and flame spreader is open

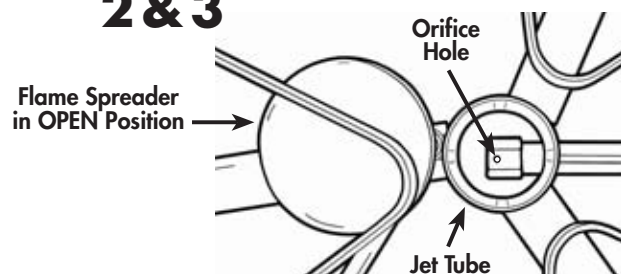

S-L-O-W-L-Y Turn LP Cylinder Valve One Full Turn counter-clockwise

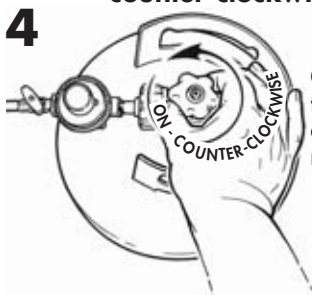

Gas will flow to and stop at closed regulator

### LIGHTING

Place lit Match above Jet Tube

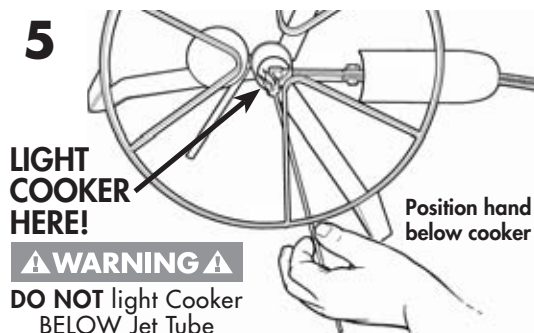

⚠ WARNING ⚠  
DO NOT light Cooker BELOW Jet Tube

S-L-O-W-L-Y Turn Regulator Valve ON counter-clockwise

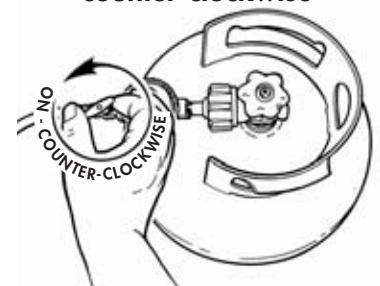

ADJUST Regulator Valve for Flame Height

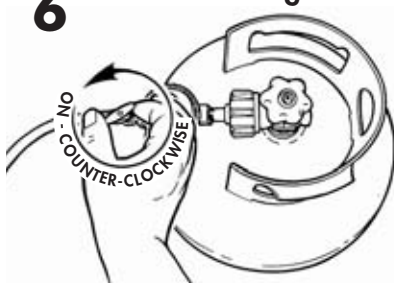

NOTE: The brass valve on regulator hose assembly controls flame intensity only. It is not an ON/OFF valve.

After lighting Burner, OPEN LP Cylinder Valve FULLY

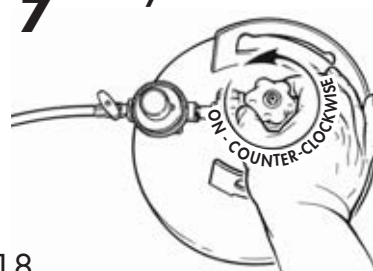

## Model #SP1 Jet Cooker - BURNER FLAME CHECK

When lighting for the first time, you will smell paint burning at the top of the cooker for a few minutes... This is normal.

### ⚠️ WARNING ⚠️ FOR YOUR SAFETY:

In bright sunlight the flame may appear invisible. **DO NOT** lean over the cooker during use. **DO NOT** wear loose clothing or allow long hair to hang freely while lighting or using the cooker.

The regulator valve controls flame intensity. Practicing adjusting flame height up and down. You will notice that this cooker emits a loud JET sound, hence the name Jet Cooker.

### HOW TO REIGNITE Model #SP1 Jet Cooker

If burner flame does NOT ignite immediately, or is accidentally extinguished, turn LP Gas Cylinder Valve clockwise to OFF. Then turn regulator valve clockwise to OFF position. Wait 5 minutes for gas to evacuate before re-lighting, then repeat steps 1-7 to re-light. Always use caution when re-lighting as cooker frame and cooking vessel will be hot.

If the cooker does not light within the first few attempts, there is a problem with the gas supply. Turn off the gas at the cylinder and regulator. **DO NOT** attempt to operate the cooker until the problem is found and corrected. Refer to Troubleshooting on Pages 30-31.

### ADJUST Regulator Valve for Flame Height

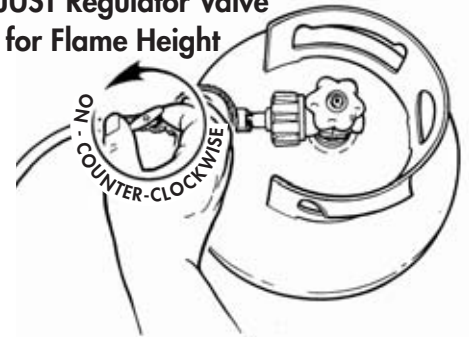

### TURNING OFF JET COOKER AND DISCONNECTING HOSE FOR Model #SP1

**NOTE:** Turn off LP gas cylinder valve first to prevent gas from being left in the regulator hose system under pressure.

1. Turn OFF the LP gas cylinder valve **clockwise** until it stops.
2. Turn regulator valve to the OFF position, **clockwise** until it stops.
3. To disconnect Regulator Hose Assembly, turn the large coupling nut **counter-clockwise** by hand.

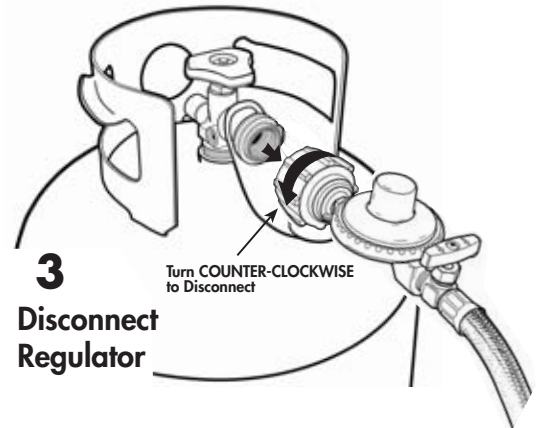
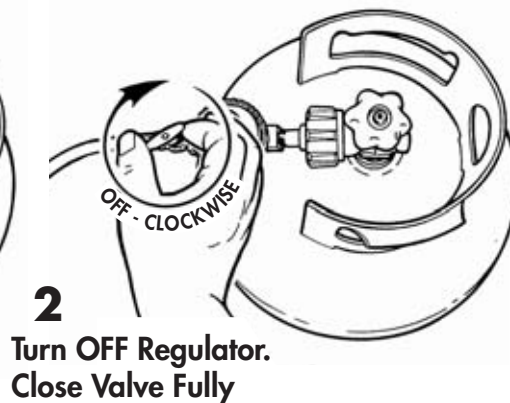
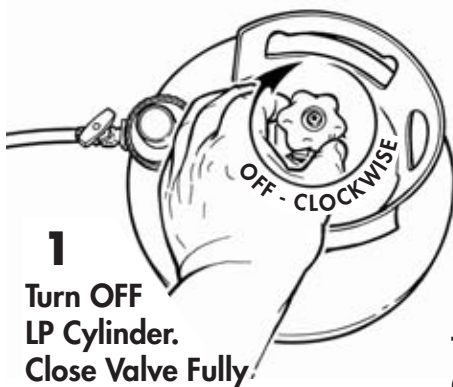

### ⚠️ WARNING ⚠️

The LP gas cylinder valve should always be in the OFF or closed position when the cooker is not in use.

# OPERATING INSTRUCTIONS

## ⚠ WARNING ⚠

Read, understand and follow all warnings and instructions contained in this manual. **DO NOT** skip any of the warnings and instructions contained in the preceding sections of this manual.

- Do not use a cooking vessel larger than 100-quart for boiling or 36-quart for frying. **DO NOT** use a cooking vessel smaller than 12" diameter on this cooker.
- Determine what size cooking vessel to use and Proper Amount of Liquid for Cooking. Follow instructions on pages 21-22.
- Make sure cooker is positioned at least 10-ft from all combustible materials including building overhangs and tree branches. Follow positioning instructions on page 15.
- Check for gas leaks. Follow Gas Leak Testing Instructions on page 13-14.
- Follow Lighting and Re-lighting Instructions for **Model #SP10 Cooker** on pages 16-17.
- Follow Lighting and Re-lighting Instructions for **Model #SP1 Jet Cooker** on pages 18-19.
- When frying, test cooking thermometer to ensure accurate temperature reading. Follow Thermometer Test and Placement Instructions on pages 20-21.
- Never leave oil unattended during preheating or cooking process as it can ignite and cause a fire. Hot cooking oil is extremely hazardous and must be monitored at all times.
- Remain attended to the cooker and when frying check the thermometer every 3 minutes.
- Never allow oil to reach FIRE HAZARD zone on the thermometer.
- Smoking oil is an indication that the oil is too hot and may ignite and cause a fire. Cooking oil/grease ignites at varying temperatures, so check thermometer every 3 minutes during oil heat-up and frying. Never allow the oil to exceed 400°F and **NEVER LEAVE HEATING OIL UNATTENDED.**
- Use extreme care when lowering food and utensils into and removing from hot oil or liquid.
- When cooking is completed, turn off gas to the cooker. Follow Disconnecting Instructions in this manual.
- Follow General Maintenance and Storage Instructions of page 32.

## THERMOMETER TEST INSTRUCTIONS

### ⚠ WARNING ⚠

Always use a thermometer when frying any food products. A thermometer is a sensitive measuring device which may not work properly if dropped, bent, or twisted. Always check to be sure your thermometer is working properly before frying. **DO NOT** use a meat thermometer for frying.

### 2-STEP METHOD for Thermometer Testing

#### 1. TEMPERATURE ACCURACY:

While wearing protective gloves, hold the thermometer by the dial and insert stem into boiling water. The needle should quickly move around the dial and register approximately 212°F (100°C) (**plus or minus 5°F**). This indicates whether or not temperature reading is accurate. **NOTE:** Due to water evaporation, the maximum reading possible on a thermometer in hot water is 212°F (100°C).

#### 2. TEMPERATURE RANGE:

Hold thermometer by the dial and place end of the stem above a lit match or lighter. The needle should quickly move around the dial and register a temperature reading far above 350°F. If the needle stops at a low temperature reading such as 225°F; then the thermometer is damaged and cannot be used. Discard the thermometer and call **1-800-864-6194 M-F 8am - 5pm CST for assistance.**

**Replacement thermometer Model #5020 or #5025.**

**DO NOT attempt frying if the thermometer is not working!**

## PLACEMENT OF YOUR THERMOMETER

1. Make sure clip on thermometer is about 2" below the dial.
2. For frying, attach the thermometer clip on the inside of the basket with the stem immersed in oil at least 1-inch.
3. DO NOT insert thermometer stem into food. This can cause incorrect thermometer reading.
4. During frying with oil, the thermometer dial indicator will continue to rise. Remain with the cooker and check the thermometer every 3 minutes to ensure the dial indicator does not stop before reaching optimum frying temperature range from 325°F to 350°F (162°C - 175°C).
5. This cooker can heat 3 quarts of cooking oil/grease to 350°F (175°C) in 3 to 5 minutes.
6. DO NOT allow cooking oil/grease to exceed 400°F (200°C) which is the **FIRE HAZARD** zone on the thermometer. Cooking oil/grease will ignite and catch fire at 550°F to 700°F (287°C to 371°C).
7. Regardless of thermometer reading, if the oil/grease starts to smoke, turn OFF fuel supply to the burner and STOP COOKING IMMEDIATELY. This indicates the thermometer is not working properly. Discard the thermometer and call **1-800-864-6194 M-F 8am - 5pm CST for assistance.**  
**Replacement thermometer Model #5020 or #5025.**

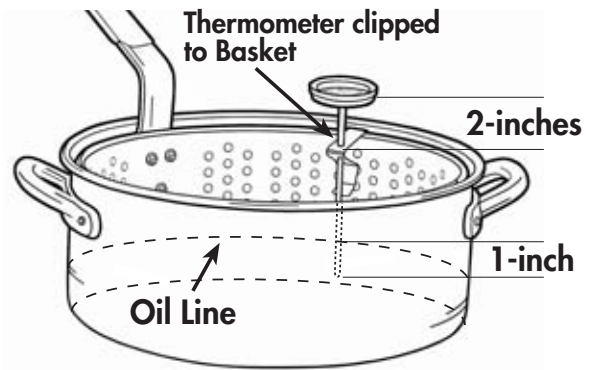

## HOW TO DETERMINE PROPER AMOUNT OF LIQUID FOR COOKING

(For use with cooking vessels that have and do not have Maximum Fill Line)

Do not use a cooking vessel larger than 100-quart for boiling or 36-quart for frying on this cooker.  
Do not use a cooking vessel smaller than 12" diameter on this cooker.

### ⚠ WARNING ⚠

If too much water or oil is inside the cooking vessel, it is possible for spillovers to occur when adding a basket filled with food product, or during a rolling boil. Spillover of hot liquids can cause severe burns and property damage. Carefully read and follow these instructions.

### BOILING WATER LEVEL DETERMINATION:

1. Place the food product in the strainer basket.
2. Place the food product and strainer basket into the empty vessel.
3. Add water into the vessel until the food product is completely submerged. There must be a minimum of 3 inches between the water level and top of the vessel.
4. Remove the food product from the vessel. The remaining water level indicates the amount needed to cook the food product. Typically, the amount of water needed for boiling is one-third full or less.

**NOTE:** For #SP-1 Jet Cooker, the flame spreader should be OPEN for boiling.

### STEAMING WATER LEVEL DETERMINATION:

### ⚠ CAUTION ⚠

Never allow all water to evaporate completely when steaming as the heat from this cooker can melt a hole in the cooking vessel.

Typically 2 to 3 inches of water is used for steaming food products. Use cooking vessel (stockpots) having perforated baskets that are elevated above the water level. Be certain your stockpot has a vented lid for steaming.

**NOTE:** For #SP-1 Jet Cooker, the flame spreader should be CLOSED for steaming.

## FRYING OIL/GREASE LEVEL DETERMINATION:

Follow the 6 steps below to determine the proper amount of oil to use in cooking vessels that do not have maximum fill lines.

1. Place the food product in the strainer basket.
2. Place the food product and strainer basket into the empty vessel.
3. Add water into the vessel until the food product is almost submerged. There must be a minimum of 3 inches between the water level and top of the vessel.
4. Remove the food product from the vessel and either mark the level on the side of the vessel or measure the amount of water in the vessel. This water level indicates the amount of cooking oil needed to cook the food product. **NOTE: Cooking oil/grease will expand when heated and increases the level inside the cooking vessel.**
5. Remove the water and completely dry the vessel and the food product.
6. Add cooking oil into the vessel up to the indicated level.

**NOTE: For #SP-1 Jet Cooker, the flame spreader should be CLOSED for frying.**

### ⚠ DANGER ⚠

IF THE INFORMATION IN ITEMS 1- 6 ABOVE IS NOT FOLLOWED EXACTLY, OIL OVERFLOW MAY OCCUR CAUSING PROPERTY DAMAGE, PERSONAL INJURY, OR DEATH.

## BOILING INSTRUCTIONS

### ⚠ WARNING ⚠

If too much water or oil is inside the cooking vessel, it is possible for spillovers to occur when adding a basket filled with food product, or during a rolling boil. Spillover of hot liquids can cause severe burns and property damage. Carefully read and follow these instructions.

1. Follow instructions to properly assemble and position the cooker. Perform gas leak test, and water level determination.
2. Add the determined amount of water into the cooking vessel.
3. Light the cooker by following Lighting Instructions on pages 16 and 18 in this manual.
4. Depending on the size of cooking vessel and volume of water used, heat up time can range from 15 to 45 minutes. Covering the cooking vessel with a lid will accelerate water heat up time to the boiling point.
5. Once water has achieved a rolling boil, reduce cooker flame as low as possible by turning regulator valve as directed.
6. Using an insulated mitt, carefully remove the lid.

**NOTE: For #SP-1 Jet Cooker, the flame spreader should be OPEN for BOILING**

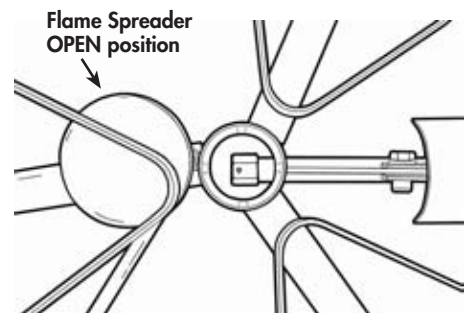

### ⚠ CAUTION ⚠

Open far side of the lid first so that steam and heat escape away from you.



- Using an insulated mitt, carefully lower the food basket into the boiling water, then place lid back on the cooking vessel. **NOTE: Immersing the food basket will quickly reduce water temperature.**
- Increase cooker flame to desired level by turning regulator control knob as directed. It will take several minutes for water temperature to increase and achieve a rolling boil.

## **⚠ CAUTION ⚠**

**Once a rolling boil is achieved, reduce cooker flame to maintain the desired level. Lowering cooker flame reduces chance of a boil over during cooking.**

### **FOLLOW 3-MINUTE : 15-MINUTE BOILING RULE**

Boiling time varies with type of food being cooked. Seafood generally has the shortest boiling time. For superior cooking results, follow these simple steps:

- Heat water to rolling boil.
- Reduce cooker flame and carefully lower food basket into boiling water and cover the pot.
- Increase cooker flame and cook until a rolling boil is achieved.
- Leaving pot covered, reduce cooker flame and allow rolling boil to continue for **3-minutes**.
- After **3-minutes** have passed, **shut off gas to the cooker**. Leave the pot covered and allow to set another **15-minutes**.

**During this 15-minute period, the food will continue to cook and absorb seasoning without being over-cooked. Generally, the 3-minute : 15-minute rule results in shrimp and crawfish being perfectly cooked, seasoned and easy to peel.**

#### **REMOVING BASKET FROM COOKING VESSEL:**

- Shut off gas to the cooker.
- Wearing an insulated mitt, carefully remove lid from pot.

## **⚠ CAUTION ⚠**

**Remember, lift the far side of lid first to protect you from escaping steam and heat.**

- Wearing an insulated mitt, carefully and slowly lift basket from the cooking vessel.
- Hold the basket above the cooking vessel to allow hot water to drain.

## **⚠ WARNING ⚠**

- Use extreme caution when lifting a food basket from boiling water.
- Be certain cooker is turned off.
- In addition to an insulated mitt, wear shoes, long pants and shirt sleeves to prevent burns from splashing hot water.
- Food baskets in stockpots from 60-qt to 162-qt are very heavy and should be a 2-person operation.
- A 2-person basket Lift Assist Bar is recommended for cooking vessels of 100-qt to 162-qt size.

- Carefully pour out the food product and... enjoy!

# STEAMING INSTRUCTIONS

Typically 2 to 3 inches of water is used for steaming food products. Use cooking vessel (stockpot) having perforated basket that is **elevated** above the water level. Be certain your stockpot has a **vented lid** for steaming.

## ⚠ WARNING ⚠

- Use an insulated mitt when lifting stockpot lid when steaming. Steam escaping through the lid vent under pressure is invisible and can cause severe burns. Use extreme caution when removing stockpot lid when steaming or boiling.
- Do not allow water to evaporate completely during steaming. The bottom of aluminum stockpots will quickly warp and melt if all water evaporates; even under a low flame. If steaming for a long period of time you will need to occasionally add water to the stockpot.

1. Follow instructions to properly assemble and position the cooker. Perform gas leak test, and water level determination.
2. Arrange food in the perforated basket.
3. Heat up time for 2 to 3 inches of water will be very fast.
4. Once boiling is achieved, reduce cooker flame by turning regulator valve as directed.
5. Using an insulated mitt, carefully lower food basket into the cooking vessel, then cover with lid. (Be certain food is not touching the water.)
6. Leave the cooker flame set low during cooking to maintain a steady boil.

**Hint: Cooked seafood turns from translucent to opaque when done.**

7. When steaming is done, turn off gas to the cooker. Wearing an insulated mitt, carefully lift the lid and remove food basket from the cooking vessel.

**NOTE: For #SP-1 Jet Cooker, CLOSE the flame spreader for STEAMING**

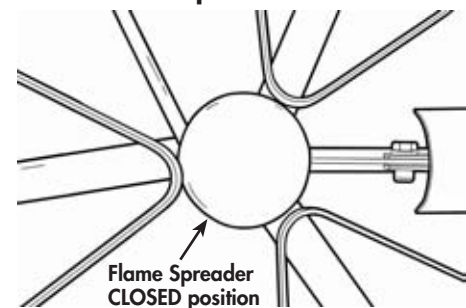

# FRYING INSTRUCTIONS (Read pages 26-27 about Cooking Oil)

## ⚠ WARNING ⚠

This cooker does not have automatic thermostat controls so must be attended and monitored at all times during use. When cooking with oil/grease, a thermometer must be used to monitor temperature. Oil/grease heated above 400°F (200°C) will ignite and catch fire causing property damage, personal injury or death.

**NOTE:** Optimum frying temperature range is 325°F to 350°F (163°C to 177°C).

1. Follow instructions to properly assemble and position the cooker. Perform gas leak and thermometer test, and oil level determination.
2. After making certain food product is thawed and towel dried, add food product into the empty basket.

## ⚠ CAUTION ⚠

Before lighting cooker, always have all food product prepared and ready for frying. This will reduce future distractions and better enable proper monitoring of thermometer and heating oil.

3. Add the determined amount of oil/grease into the cooking vessel.
4. Attach your thermometer to the pot, making certain the stem is immersed into the oil at least 1-inch.

**⚠ CAUTION ⚠**  
**Thermometer shall be attached to the cooking vessel for heat-up period only. Later, attach thermometer to the basket for frying.**

**NOTE: For #SP-1 Jet Cooker, CLOSE the flame spreader for FRYING**

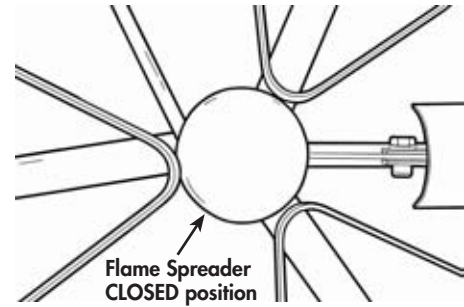

5. Light the burner on the cooker as described.  
**NOTE:** Spend a few moments to adjust the flame up and down to become familiar with flame adjustment process.
6. Reduce burner flame to lowest possible setting and carefully set cooking vessel with oil and thermometer onto the cooker.
7. Increase flame to desired level and monitor your thermometer. When using 3-quarts of oil or less, the heat-up time to reach 325°F to 350°F will take from 3 to 5 minutes. Actual heat-up time will vary depending on type and amount of oil used, regulator setting, ambient temperature and wind.

**⚠ WARNING ⚠**  
**DO NOT cover cooking vessel with a lid during oil heat-up or frying. This can cause oil to heat faster, overheat, ignite and cause a fire.**

8. When temperature reaches 325°F - 350°F, reduce burner flame to lowest level. Wearing a protective glove, remove thermometer from pot and attach to side of perforated basket with food product already placed inside.

**⚠ WARNING ⚠**  
**Thermometer will become very hot and cause burns if touched by bare hands. Always wear protective gloves or mitts when handling a hot thermometer.**

9. Leaving burner flame at lowest setting, and wearing a protective glove, carefully and S-L-O-W-L-Y lower the basket, with thermometer attached, and food product into the cooking oil. **Inserting the food product into hot oil will cause a brief and furious spatter, and will quickly reduce oil temperature. Once spatter subsides, increase the flame so that temperature can return to 325°F - 350°F.**
10. Frying time will be fast so NEVER LEAVE COOKING UNATTENDED and constantly monitor your thermometer.

**⚠ WARNING ⚠**  
 Regardless of thermometer reading, if the oil/grease starts to smoke, turn OFF fuel supply to the burner and STOP COOKING IMMEDIATELY. This indicates the thermometer is not working properly. Discard the thermometer and call **1-800-864-6194 M-F 8am - 5pm CST for assistance.**  
**Replacement thermometer Model #5020 or #5025.**

11. When frying is complete, first turn off gas supply at the cylinder valve, then close regulator valve. Do this before removing the basket from hot oil.
12. Wearing protective gloves, carefully remove basket from oil. Keep basket above the pot to drain.
13. After hot oil has sufficiently drained, carefully remove food from basket. Allow liquid to cool to 115°F (45°C) or below before moving cooking vessel.

## **⚠ WARNING ⚠**

**Fryer thermometer should not be inserted into food or touching food when measuring temperature of cooking oil. End of the thermometer stem should be at least 1 inch below oil level.**

## **⚠ CAUTION ⚠**

**Wait for oil to cool to or below 115°F (45°C) before pouring into its plastic container. Hot oil can melt the plastic and cause severe burns or bodily harm.**

### **COOKING NOTE:**

When frying the very first basket of food product, the food may reach proper doneness **before** the cooking oil returns to the optimum frying range between 325°F to 350°F. This is normal.

For subsequent basket loads of food, the oil should return to the 325°F to 350°F cooking range while the food product fries to proper doneness.

As cooking process continues, a steady frying temperature can be maintained with burner flame adjusted to a lower setting.

## **COOKING OIL: Important Facts to Know**

Since early times when human civilization first developed pots and pans, people have used various forms of cooking oil for frying. Originally animal fat (grease/lard) was used for frying which now is mostly replaced by olive, vegetable and peanut oil.

It is almost universal knowledge that over-heated cooking oil will catch fire and burn. Cooking oil has a flashpoint temperature ranging from 550°F to 700°F, depending on type of oil used, altitude, wind, and ambient temperature. However, most people do not realize that cooking oil typically **does not burn** when below its flashpoint temperature.

Cooking oil contained inside the confines of a stockpot, skillet or pan (vessel) is quite stable when below its flashpoint temperature. For example, heated cooking oil at optimum frying range of 325°F to 350°F does not catch fire even if a flame is accidentally placed in contact with the oil. This stable characteristic enables cooking oil to be used on kitchen stoves inside hundreds of millions of homes worldwide. Imagine someone smoking while frying at 350°F and the cigarette falls into the hot oil. The fire inside the cigarette will be extinguished by hot 350°F cooking oil very similar had it fallen into water.

On the other side, cooking oil must be respected and used responsibly. As cooking oil is heated up approaching flashpoint temperature, it becomes unstable and begins to breakdown. As cooking oil breaks down, vapors are created that when mixed with oxygen, will burn. When heated to very high temperatures, cooking oil vapors will **self-ignite**.

**The following is a typical scenario of what happens as vegetable oil, contained in a cooking vessel, reaches its flashpoint temperature and self ignites:**

- The oil first becomes darker and emits an unpleasant odor.
- At about 440°F, the oil begins emitting a pale vapor smoke.
- At about 500°F, the smoke turns black.
- Soon a heavy, thick black smoke belches out.
- At about 600°F, a small flame flickers out from the oil. At this point the cooking oil has reached its point of self-ignition.
- If the heat source below the vessel remains engaged, the flame will quickly grow.
- All the while cooking oil burns, thick black smoke continues to belch forth.

Another point many people do not know is that over-heated cooking oil that catches fire can make a **huge flame**. For example, a small 12" skillet with only 1/2" deep of cooking oil can create a flame **7- ft to 9- ft** high! A large cooking vessel containing up to 3 gallons of cooking oil can create a flame up to **15- ft** high!

On average, every year in the U.S. there are 80,000 kitchen/house fires caused by burning cooking oil that are responded to by a Fire Department. Imagine a 3- ft high kitchen stove supporting a cooking vessel emitting a 7- ft flame... that is a dangerous house fire!

The vast majority of these kitchen fires are the result of leaving cooking oil unattended. Simply answering the door bell, phone or tending to a crying child are sufficient distractions that allow a 12" skillet with 1/2" cooking oil to over-heat and catch fire.

**Eventually, burning cooking oil will self extinguish. Actual burn out time does vary but on average:**

- A 12" skillet with 1/2" deep cooking oil will self extinguish in about 5-7 minutes after first flame emits.
- A cooking vessel with 3-gallons of cooking oil will self extinguish in about 20-25 minutes after the first flame emits.

**Either way a very large flame is raging long enough to spread fire to any combustible structure that it touches.**

Another well known point is that cooking oil can be **re-used**. Most cooking oil brands recommend using oil 4-5 times if it is strained, and can be stored in a cool dark place from 9- 12 months.

During the storage period bacteria will form on poultry, fish or animal fats remaining in the oil. This bacteria is quickly killed when the oil is re-heated. Prior to using again, it is recommended that you smell the cooking oil. If it smells unpleasant or rancid, discard properly and use new cooking oil.

However, most people are unaware that used cooking oil has a **reduced** Smoke Point and Flash Point temperature due to partial breakdown of the oil. (Partial break-down is caused by previous use and bacteria) Although safe for normal use, this is just another reason to never, ever leave cooking oil unattended during heat up and cooking.

**Cooking Oil facts to Remember:**

- 100% peanut Oil is considered a very stable cooking oil having a higher Smoke and Flash Point temperature than other vegetable oils.
- Some cooking oil is sold as a "blend" of vegetable and peanut oil.
- Re-used Vegetable and Peanut Oil both have reduced Smoke and Flash Point temperatures.
- As a result, Flash Point temperature of cooking oil ranges from 550°F to 700°F.

**Remember; Think Safety and use Common Sense when frying with cooking oil/grease.**

# TROUBLE SHOOTING TIPS FOR Model #SP10 Cooker

Sometimes the burner does not light or has a only a meager match flame. Other times, the flame blows out, burns yellow, or there is a flame inside the burner tube. These symptoms are common and easy to remedy. **The following Trouble Shooting Tips cover most questions and problems associated with outdoor gas cooker appliances. Save this manual for future reference.**

## 1. SYMPTOM:

Burner lights but the flame remains very small and will not increase for heat-up and cooking.

## CAUSE:

Both LP cylinder and regulator couplings contain an **EXCESS FLOW** safety device that shuts off 90 percent of gas flow should the hose be cut or severed. **Sometimes this safety device can be activated when lighting the burner.** Opening the cylinder valve and/or regulator valve **too quickly** can create the rapid flow of gas that activates the excess flow safety device.

## POSSIBLE SOLUTION:

Repeat **Lighting Instructions** steps 1 through 6 on page 16. Follow lighting instructions and be certain to **S-L-O-W-L-Y** open cylinder valve **one full turn**, then **S-L-O-W-L-Y** open regulator valve when lighting.

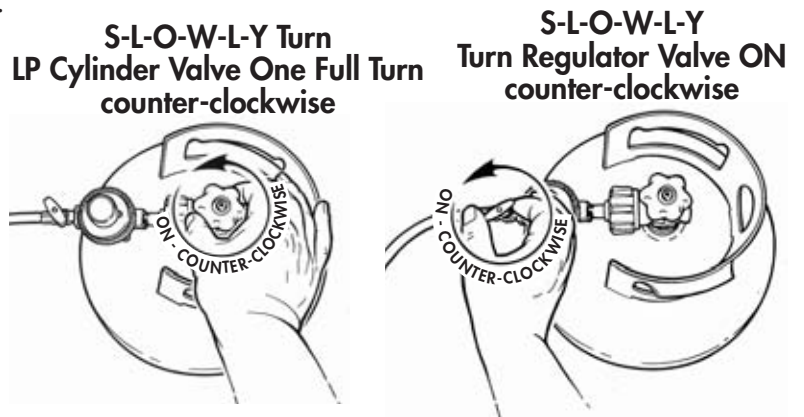

## 2. SYMPTOM:

Burner will not light .

## CAUSE:

Blockage in burner from insects, spider webs, dirt, dobeber or wasp nests and debris. This is a frequent problem in the Deep South.

## POSSIBLE SOLUTION:

Clean burner to remove spiders, insect nests and other debris.

1. Turn gas OFF at LP cylinder valve and at regulator control knob.
2. Disconnect regulator hose assembly from burner and remove air control shutter.
3. Turn cooker frame upside down. Disconnect retaining nut from burner support bar, then remove burner from frame.
4. Loosen and disconnect central bolt from burner and remove flame spreader from burner cup.

**NOTE: Wear eye protection when cleaning burner.**

5. Use a narrow bottle brush or a stiff wire bent into a small hook to run through the burner tube. Push the bottle brush or bent wire back and forth through the burner tube.
6. Hold the burner with the tube facing down and spray water from a garden hose into the opening in the burner cup.
7. It may be necessary to repeat steps 5 & 6 until water flows freely out of the burner tube.
8. Wire brush entire surface of burner to remove food residue and dirt.
9. Wire brush bottom of flame spreader and side ports to be certain all grooves are free of debris.
10. Re-assemble flame spreader and air shutter on burner. Reinstall burner, heat shield and locking nut on support bar inside cooker stand. Re-connect hose to burner.
11. If burner is damaged, obtain a replacement burner. **Model BG10 Burner for #SP10 Cooker**

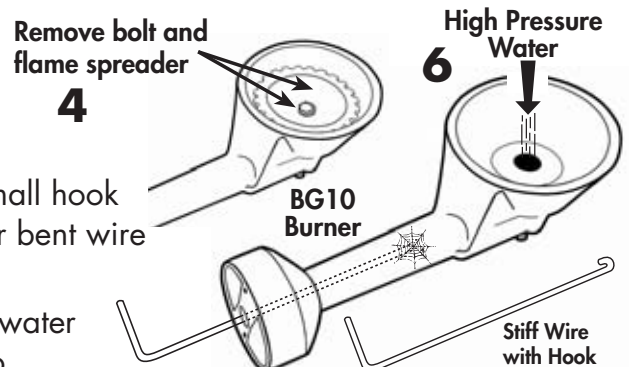

# TROUBLE SHOOTING GUIDE FOR Model #SP10 Cooker

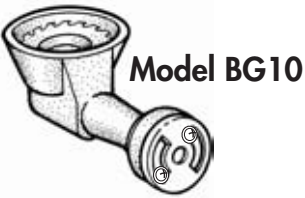
SYMPTOM	CAUSE	POSSIBLE SOLUTION
<b>Burner lights but the flame remains very small</b> Repeated from page 22	Rapid gas flow from propane tank activates EXCESS FLOW safety device	Repeat lighting instructions and be certain to S-L-O-W-L-Y open cylinder valve one full turn, then S-L-O-W-L-Y open regulator valve to light burner
<b>Burner will not light</b> Repeated from page 22	Blockage in burner from spider webs, insects, dirt dobbbers and debris	Disconnect hose from burner. Clean and check burner for spiders, insect nests and debris
<b>Burner will not light and burner tube is clean</b>	Too much air and not enough gas	Turn air shutter to almost closed position, then re-light the burner
	Not enough gas flow from propane tank	Open propane tank valve all the way
	Low gas level in propane tank, or tank is empty	Check gas level in propane tank, re-fill or exchange tank
	Faulty burner	Contact <b>1-800-864-6194; Model BG10</b>
<b>Yellow, sooty, irregular flame</b>	Air shutter not adjusted correctly causing too much gas in mixture	Adjust air shutter on the burner until flame is blue - See page 17
	Blockage in burner	Clean and check burner for spiders, insect nests and debris
<b>Hissing or gurgling sounds coming through regulator hose assembly from tank to burner</b>  <b>WARNING</b> <b>Do not use this appliance if gas leaks cannot be stopped and corrected.</b>	Water in burner	Check burner for moisture, make sure burner is dry
	Damaged hose	Perform soapy water test to check for cracks in hose. See pages 13-14; <b>Model M5HPR-1</b>
	Gas leak	Perform soapy water test to check all connections - See pages 13-14
<b>Flame has gone out</b> 	Low gas level in propane tank, or tank is empty	Check gas level in propane tank
	Too much wind	Check wind direction and set cooker away from windy areas
	Blockage in burner	Clean and check burner for spiders, insect nests and debris
	Water in burner	Check burner for moisture, make sure burner is dry
	Faulty burner	Contact <b>1-800-864-6194; Model BG10</b>

# TROUBLE SHOOTING TIPS FOR Model #SP1 Jet Cooker

Sometimes the cooker does not light or has a only a meager match flame. Other times, the flame blows out, burns yellow, or there is a flame inside the burner tube. These symptoms are common and easy to remedy. **The following Trouble Shooting Tips cover most questions and problems associated with outdoor gas cooker appliances. Save this manual for future reference.**

## 1. SYMPTOM:

Burner lights but the flame remains very small and will not increase for heat-up and cooking.

## CAUSE:

Both LP cylinder and regulator couplings contain an **EXCESS FLOW** safety device that shuts off 90 percent of gas flow should the hose be cut or severed. **Sometimes this safety device can be activated when lighting the burner.** Opening the cylinder valve and/or regulator valve **too quickly** can create the rapid flow of gas that activates the excess flow safety device.

## POSSIBLE SOLUTION:

Repeat **Lighting Instructions** steps 1 through 6 on page 16. Follow lighting instructions and be certain to **S-L-O-W-L-Y** open cylinder valve **one full turn**, then **S-L-O-W-L-Y** open regulator valve when lighting.

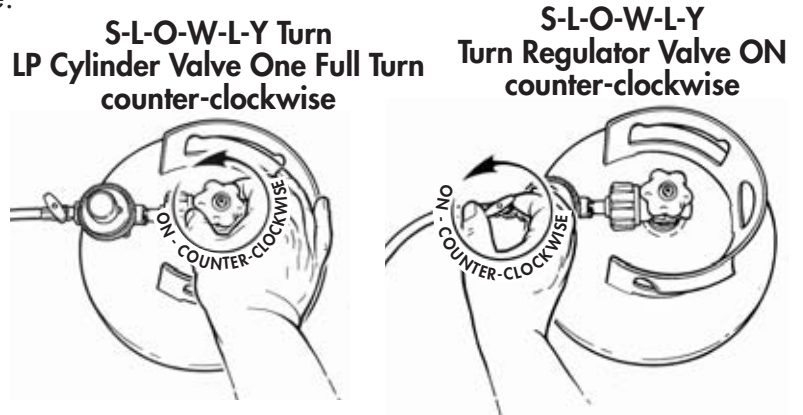

## 2. SYMPTOM:

Cooker will not light .

## CAUSE:

Orifice hole at bottom of jet tube may not be facing straight up, or has a blockage.

## POSSIBLE SOLUTION:

Turn orifice hole to point straight up in jet tube or clean orifice hole of debris.

1. Using a wrench, turn brass cap at bottom of jet tube until orifice hole is facing straight up.
2. Using a thin wire; insert into the orifice hole to remove blockage debris.

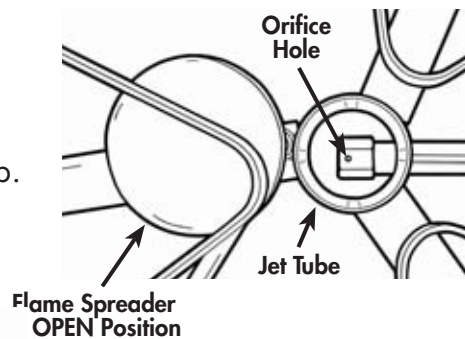

## MODEL #SP1 JET COOKER





## TROUBLE SHOOTING GUIDE FOR Model #SP1 Jet Cooker

SYMPTOM	CAUSE	POSSIBLE SOLUTION
<b>Cooker lights but the flame remains very small</b> Repeated from page 22	Rapid gas flow from propane tank activates EXCESS FLOW safety device	Repeat lighting instructions and be certain to S-L-O-W-L-Y open cylinder valve one full turn, then S-L-O-W-L-Y open regulator valve to light cooker
<b>Cooker will not light</b> Repeated from page 22	Orifice Hole in Jet Tube is not facing straight up	Using a wrench, turn brass cap until orifice hole is facing up
	Orifice hole is blocked	Using a wire, insert into orifice hole to remove blockage debris
<b>Burner will not light and burner tube is clean</b>	Not enough gas flow from propane tank	Open propane tank valve all the way
	Low gas level in propane tank, or tank is empty	Check gas level in propane tank, re-fill or exchange tank
	Faulty regulator hose assembly	Contact <b>1-800-864-6194; Model M5HPR-1</b>
<b>Hissing or gurgling sounds coming through gas train from tank to burner</b>  <b>⚠ WARNING ⚠</b> <b>Do not use this appliance if gas leaks cannot be stopped and corrected.</b>	Damaged hose	Perform soapy water test to check for cracks in hose. See pages 13-14; <b>Model M5HPR-1</b>
	Gas leak	Perform soapy water test to check all connections - See pages 13-14
<b>Flame has gone out</b>	Low gas level in propane tank, or tank is empty	Check gas level in propane tank
	Too much wind	Check wind direction and set cooker away from windy areas
	Blockage in jet tube	Clean and check burner for spiders, insect nests and debris

## GENERAL MAINTENANCE & STORAGE

Intense heat from the cooker will burn away paint from parts of the frame, windscreen flashing, and flame spreader. This is normal and will cause a slight 'odor' for a few minutes during the initial use. The exposed steel will rust. Occasional care must be taken to prolong the life of your cooker.

1. Store cooker in a dry place. Do not store outside exposed to weather. Storage of a gas cooker appliance indoors is permissible only if the cylinder is disconnected. If storing cooker indoors, detach and leave LP cylinder outdoors. LP cylinders must be stored outdoors out of the reach of children and must NOT be stored in a building, garage or any other enclosed area.
2. Occasionally spray paint on affected areas of cooker frame after it has cooled.
3. Spray WD-40 on the burner grid after it has cooled.

### **DANGER**

**Spray paint and other aerosols contain flammable PETROLEUM DISTILLATES under pressure. Flame from burner or heat from cooker may cause spray can to burst violently resulting in death, serious burns and bodily harm. Perform all touch up maintenance to a cool, dry cooker frame and burner, below 115°F (45°C).**

4. For long term storage, cover cast iron burners, regulator hose assembly, and jet tube in a plastic bag.
5. Spiders and small insects have been known to spin webs inside the burner tube. Obstructions in the burner tube interfere with the flow and mixture of air and gas through the burner. A clogged burner tube may result in a fire beneath the appliance. If this happens, clean the burner tube with a stiff, bent wire. **Burner Tube for Model #SP10; Jet Tube for Model #SP1**
6. Turn air control shutter to closed position after each use to reduce chance of insect intrusion.  
( for Model #SP-10 only)
7. Do not tamper with or attempt repairs on the burners, frames, regulator valves, or LP cylinder. Allow only qualified LP gas dealers to make repairs. For replacement parts call Barbour International, Inc. at **1-800-864-6194**.
8. Always close LP cylinder valve first after use. Always use and store LP cylinder in an upright position. Never store or transport LP cylinders in occupied enclosures.
9. Check and tighten any loose hardware before each use.
10. Never store cooking liquids in aluminum cooking pots. Salt and seasoning will form pit holes in the bottom of the pot resulting in cooking oil leaking onto the open burner flame.

### **WARNING**

**Discard any aluminum cooking vessel should cooking oil leak through pit holes. Leaking oil will ignite and cause a fire.**

11. Inspect entire cooker including regulator hose assembly and burner assembly before each use. Replace any damaged or worn parts. Use only parts specified by Barbour International, Inc.

## CARE & USE INSTRUCTIONS FOR COOKWARE

### Polished Aluminum Pots

1. It is recommended to season the pot before use. Pour small amount of vegetable oil inside and spread it with a paper towel until the entire bottom and sides are coated. Let it stand for 10 minutes. Wash out the interior of the pot, it will be ready to use. **DO NOT** apply to flame during any of this process.

## **⚠ CAUTION ⚠**

**Empty aluminum pots will melt if placed on cooker over an open flame.**

2. After cooking, let pans and lids cool gradually. Do not pour cold water into a hot pan. This can cause the bottom of the pan to warp, and it can cause oil/grease to splatter. Always wash the pans thoroughly in hot, soapy detergent after each use to remove all traces of food, salt, or grease particles that will burn causing stains when the pan is reheated.
3. Seasoning the pots will make cleaning easier. Scouring pads and aluminum cleaners are okay for the interior of the pots, but will scratch the exterior.
4. Polished aluminum pots will tarnish and discolor with normal use.  
**Our motto is: "The uglier the pot, the better it cooks!"** Occasional use of "Cream of Tartar" will bring back some of the luster. However, aluminum pots will tarnish and become dull with normal use.
5. Boiling with large quantities of salt is very corrosive and can cause **pits** in the pot and basket. To reduce the chance of this occurring, do not allow salt water or seasoned oil/grease to remain in the pot for a long period of time after the pot has cooled. The basket and pot should be thoroughly cleaned after each use. **DO NOT** store cooking oil inside the pots. Salt and seasonings will settle and can cause pits to form at the bottom of the pot.

### Stainless Steel Cookware

1. Before using for the first time, wash in hot soapy water. Dry immediately to prevent water spots. To prevent scratches, avoid using sharp utensils when cooking.
2. Discoloration of stainless steel cookware will result if the pieces are allowed to overheat excessively. For hard-to-clean stains or discoloration of the stainless steel, use a nonabrasive stainless steel cleaner. Follow the directions on the container using a clean, damp sponge or cloth. Do Not scrub finish with a soap-filled steel wool pad or harsh abrasive cleanser as scratching will occur.

### Cast Iron Cookware Seasoning Instructions

Seasoning prevents rust & keeps food from sticking.

1. Wash cast iron cookware in warm soapy water to remove the Paraffin wax coating.
2. Rinse and dry thoroughly.
3. Coat the entire surface of the cookware with solid vegetable shortening. Place in 300°F oven for one hour. **Hint:** Season the cookware outside in a gas grill keeping smoke and vapors away from the house.
4. Remove from oven or gas grill, pour out excess grease and wipe with a paper towel. Properly seasoned cast iron cookware will turn black after repeated use. This is normal.

# OTHER PRODUCTS BY BAYOU CLASSIC®



**Stainless Steel and Aluminum Stockpots**  
24-Qt. - 162-Qt.



**Stainless Steel Stockpots with Spigot**  
36-Qt. & 44-Qt.



**Cast Iron Cookware**  
Dutch Ovens, Skillets, Griddles, and more



**10 PSI**  
**M2HPH**  
High Pressure LPG  
Dual Stainless Braided Hoses



**Stainless Steel 6-PC. Brew Kettle Set**  
8, 10 & 16-Gallon



**5020 or 5025**  
5" or 12" Stainless Steel  
Thermometer



**DB250**  
Dual Burner  
High Pressure Cooker



**SP2**  
Double Jet Cooker  
with Hose Guard



**SQ14**  
Outdoor Patio Stove



**KAB6**  
Bayou® Cooker  
with Hose Guard

**Jambalaya Kits**  
4-Gal. to 30 Gal.



**CHECK OUT  
OUR WEBSITE!**

**[www.thebayou.com](http://www.thebayou.com)**

For Questions and Information call us at: **1-800-864-6194**  
Monday - Friday 8:00am - 5:00pm CST

**Barbour International, Inc. • 101 Cypress Way • Brandon, MS 39042**