



MANUFACTURED BY:
 Backyard Discovery
 3305 Airport Drive, Pittsburg, KS 66762
 800-856-4445

Basepoint Business Centre: Rivermead Drive, Westlea, Swindon SN5 7EX Phone: 0800-118-2476
 J.P. Coenstraat 7, The Bridge, The Hague, 2595 WP, Netherlands Phone: 0800-567-8990

SWEETWATER PLAYHOUSE Model # 2303010



WARNING

Adult Assembly Required.

The assembly manual must be retained since it contains important information

Not suitable for children under 24 months due to small parts.

FOR DOMESTIC USE ONLY. INTENDED FOR OUTDOOR USE.

CAN ICES-003 (B)/NMB-003(B)



Please visit www.backyarddiscovery.com

For the most up to date assembly manual, to register your set, or to order replacement parts

Para obtener instrucciones en español, visite www.backyarddiscovery.com



**EASY STEP-BY-STEP
 3D INTERACTIVE INSTRUCTIONS**

DOWNLOAD THE FREE APP



**INSTALLATION
 SERVICES
 AVAILABLE!**
 See inside for details

Made in China
 INS-2303010-A-SWEETWATER-ENG 09/19/22

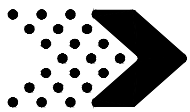

Selecting the correct location for your play product is important for your children's safety and the product's longevity

- The safe play area refers to a zone extending 6'-7" (2m) beyond the play product on all sides, including the space above the play product.

SAFE PLAY AREA DIAGRAM

Ground Dimension

3'-5 7/8" (1.1 m) x 3'-10 5/8" x (1.2 m) x 4' 7-3/8" (1.4 m)

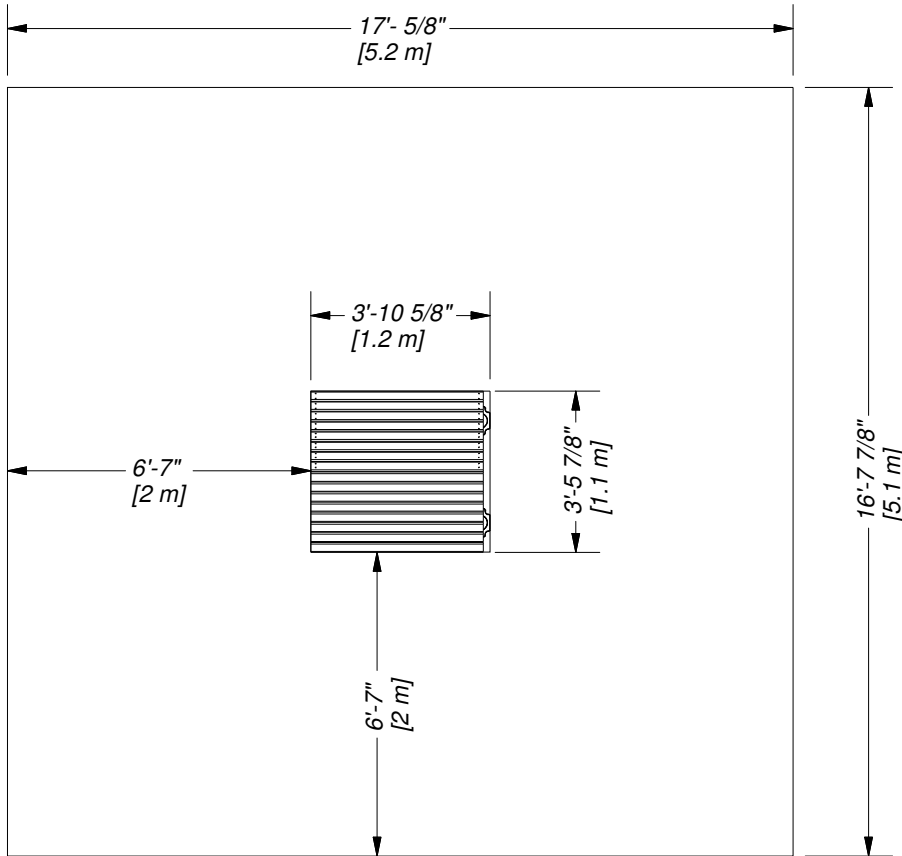

Safe Play Area

16'-7 7/8" (5.1 m) x 17'- 5/8" (5.2 m)

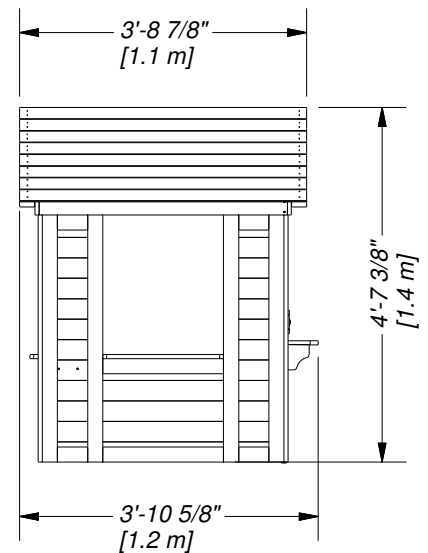

SAFE PLAY HEIGHT: 11'-2 3/8" [3.4 m]
MAXIMUM FALL HEIGHT: 4' 7-3/8" [1.4 m]

General Information:

Your set has been designed and engineered for children only and for residential use only.
 A maximum of 150 lbs. per child is recommended for play activities designed for individual use.
 A maximum of 120 lbs. per child is recommended for play activities designed for multiple child use.
 A maximum of 9 children is recommended for this swing set.

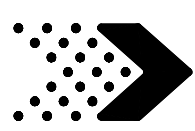

CLASS B DIGITAL DEVICE STATEMENT

Note:

This equipment has been tested and found to comply with the limits for a Class B digital device, pursuant to part 15 of the FCC Rules. These limits are designed to provide reasonable protection against harmful interference in a residential installation. This equipment generates, uses and can radiate radio frequency energy and, if not installed and used in accordance with the instructions, may cause harmful interference to radio communications. However, there is no guarantee that interference will not occur in a particular installation. If this equipment does cause harmful interference to radio or television reception, which can be determined by turning the equipment off and on, the user is encouraged to try to correct the interference by one or more of the following measures:

- Reorient or relocate the receiving antenna.
- Increase the separation between the equipment and receiver.
- Connect the equipment into an outlet on a circuit different from that to which the receiver is connected.
- Consult the dealer or an experienced radio/TV technician for help

Caution: Changes or modifications not expressly approved by the party responsible for



Wood Components (Not to Scale)



D1 | COUNTER TOP SUPPORT - W4L17067
(x1) | 1 3/8"x4 3/8"x5 7/8" (36x112x150)



J1 | COUNTER TOP SUPPORT - W4L17068
(x2) | 1"x2 3/8"x5 7/8" (24x60x150)

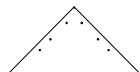

K1 | TRIANGLE SUNBURST - W4L17069
(x2) | 5/8"x5 1/4"x10 3/8" (16x134x265)

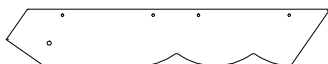

L1 | GABLE BOARD - W4L17070
(x4) | 5/8"x4 3/8"x25 3/8" (16x112x643)



M1 | COUNTER TOP - W4L17071
(x4) | 5/8"x3 3/8"x18 1/2" (16x86x469)

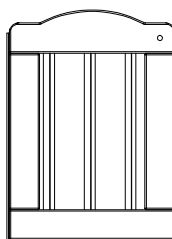

DP1 | DOOR ASSEMBLY - W2A03681
(x1) | 1 1/4"x13 1/8"x17 15/16" (32x334x456)

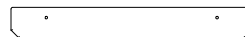

N1 | SIDE WINDOW SHELF - W4L17072
(x2) | 5/8"x2 3/8"x18 7/8" (16x60x479)

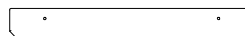

N2 | REAR WINDOW SHELF - W4L17073
(x1) | 5/8"x2 3/8"x19 1/8" (16x60x485)



N3 | DOOR STOP - W4L17074
(x1) | 5/8"x2 3/8"x3 7/8" (16x60x100)



N4 | TIE STRAP - W4L17075
(x8) | 5/8"x2"x3 1/8" (16x50x80)



N5 | SUNBURST LEG - W4L17076
(x2) | 5/8"x2 3/8"x9 7/8" (16x60x250)

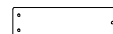

N6 | SUNBURST LEG - W4L17077
(x4) | 5/8"x2 3/8"x8 1/4" (16x60x210)

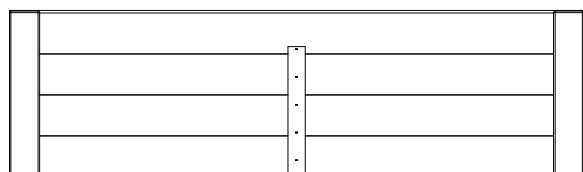

RP1 | LOWER ROOF PANEL - W2A02982
(x2) | 1 3/8"x13"x44 7/8" (35x329x1140)

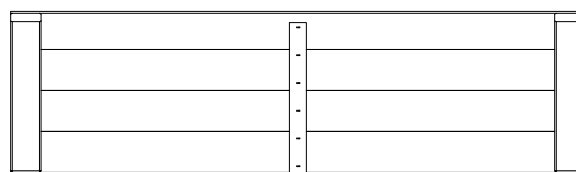

RP2 | UPPER ROOF PANEL - W2A02983
(x2) | 1 3/8"x12 3/4"x44 7/8" (35x324x1140)

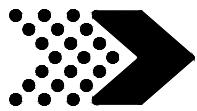

Wood Components (Not to Scale)

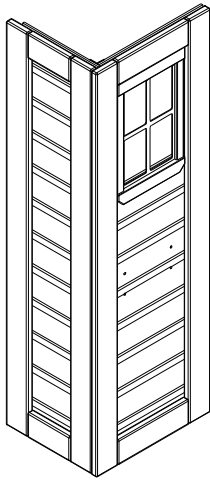

WP1 | LEFT FRONT CORNER PANEL - W2A03682
(x1) | LENGTH 38 9/16" (980)

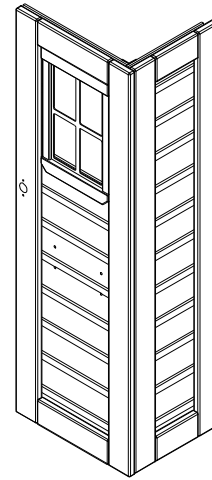

WP2 | RIGHT FRONT CORNER PANEL - W2A03685
(x1) | LENGTH 38 9/16" (980)

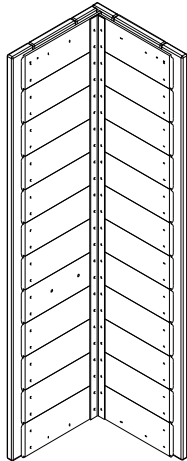

WP3 | LEFT REAR CORNER PANEL - W2A03688
(x1) | LENGTH 38 9/16" (980)

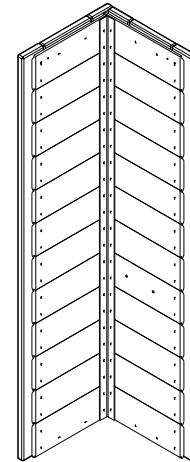

WP4 | RIGHT REAR CORNER PANEL - W2A03691
(x1) | LENGTH 38 9/16" (980)

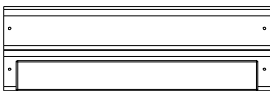

WP5 | LOWER CENTER WALL - W2A03694
(x2) | 1 1/2"x6 9/16"x20 7/8" (38x167x530)

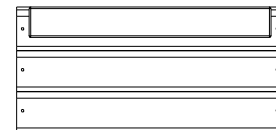

WP6 | UPPER CENTER WALL - W2A03695
(x2) | 1 1/2"x9 3/4"x20 7/8" (38x248x530)

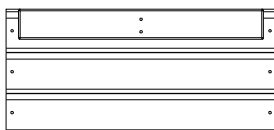

WP7 | UPPER REAR CENTER WALL - W2A03696
(x1) | 1 1/2"x9 3/4"x21 1/8" (38x248x536)



WP8 | LOWER REAR CENTER WALL - W2A03697
(x1) | 1 1/2"x6 9/16"x21 1/8" (38x167x536)

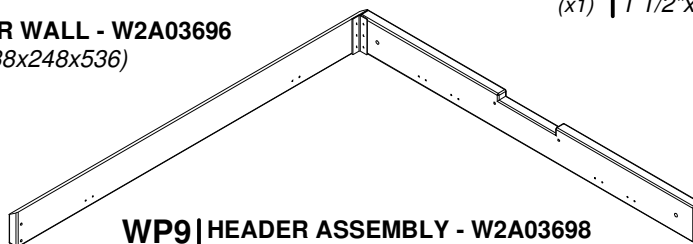

WP9 | HEADER ASSEMBLY - W2A03698
(x2) | 3 3/8"x37 7/8"x38 7/8" (86x962x986)



Hardware Components

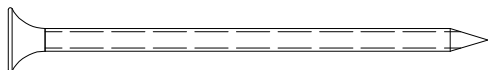

H100090 | SCREW PFH
(x6) | 8x2 1/2"

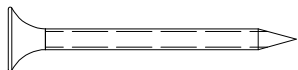

H100086 | SCREW PFH
(x22) | 8x1 1/2

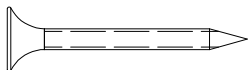

H100087 | SCREW PFH
(x53) | 8x1 1/4



H100088 | SCREW PFH
(x30) | 8x1 1/8



H100085 | SCREW PFH
(x38) | 8x1

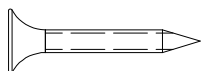

H100537 | SCREW PFH SD
(x2) | 8x1

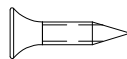

H100624 | SCREW PFH BLK
(x2) | 6x5/8

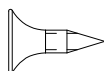

H100124 | SCREW PFH
(x2) | 8 x 1/2

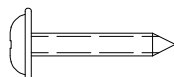

H100070 | SCREW PWH
(x8) | 8x3/4

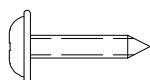

H100128 | SCREW PWH
(x2) | 8x5/8

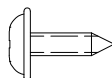

H100361 | SCREW PWH
(x2) | 8x7/16

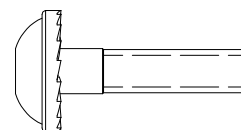

H100137 | BOLT WH
(x4) | 1/4x1

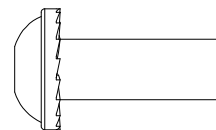

H100140 | NUT BARREL WH
(x4) | 1/4x7/8

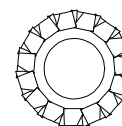

H100138 | WASHER LOCK EXT
(x4) | 6x15

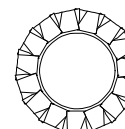

H100139 | WASHER LOCK EXT
(x4) | 8x15

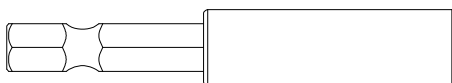

H101100 | MAGNETIC DRIVER
(x1)

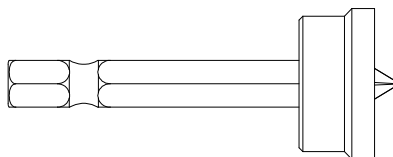

H100764 | SCREW SETTER
(x1)

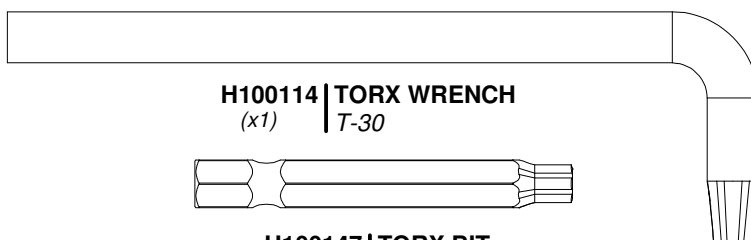

H100114 | TORX WRENCH
(x1) | T-30

H100147 | TORX BIT
(x1) | T-30



Accessory Components (Not to Scale)

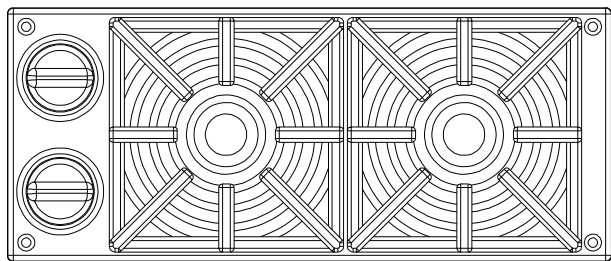

A6P00025 | STOVE KIT
(x1)

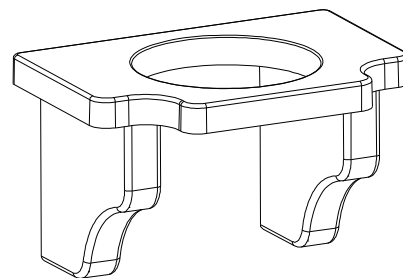

A6P00387 | FLOWER POT HOLDER - BLK
(x2)

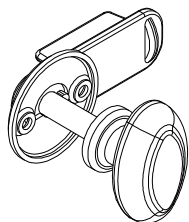

A6P00020 | KNOB KIT
(x1)

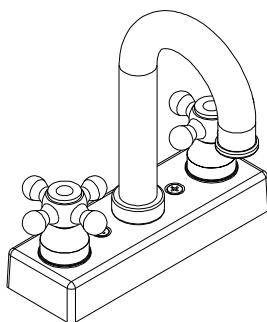

A6P00024 | FAUCET KIT
(x1)

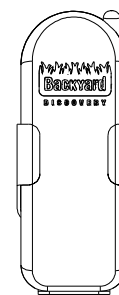

A100132 | PHONE KIT
(x1)



BE SURE TO WASH ALL PLASTIC TOYS BEFORE USE.

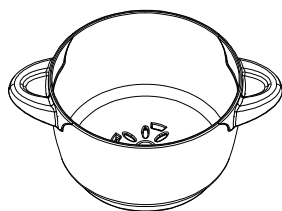

A6P00336 | BOIL POT
(x1)

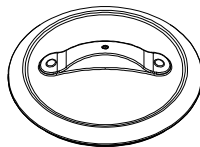

A6P00337 | POT/PAN LID
(x1)

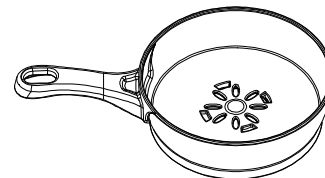

A6P00338 | FRY PAN
(x1)

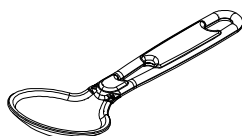

A6P00340 | LADLE
(x1)

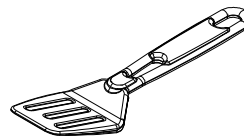

A6P00339 | SPATULA
(x1)

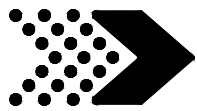

Accessory Components (Not to Scale)

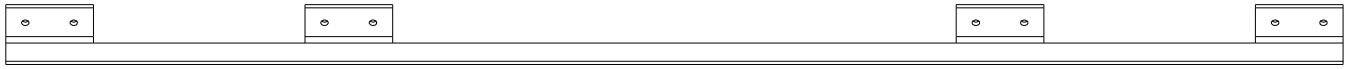

A4M00517 | METAL TIE STRAP
(x1)

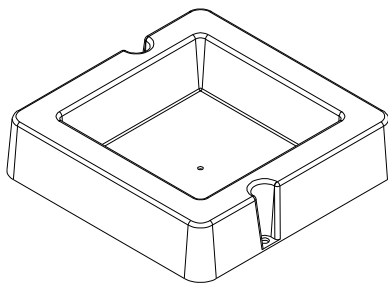

A6P00032 | SURFACE MOUNT BASIN
(x1)



A4M00528 | BYD ID TAG (MEDIUM) AGES 2 TO 10
(x1)

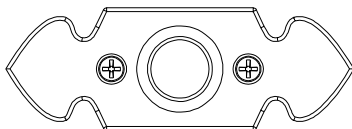

A6P00290 | DOOR BELL PLATE
(x1)

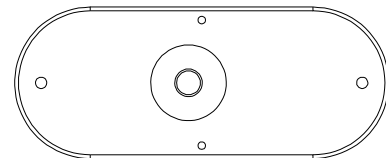

A100174 | DOOR BELL
(x1)

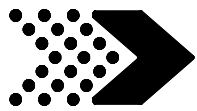

STEP 1

PRE-ASSEMBLY - SORTING PARTS

It is critical for ease of assembly that you take the time to sort and organize the wood and hardware.

WOOD PARTS:

- Organize wood parts by the three-digit, alpha-numeric number stamped on each board (ex. P01).
- If there are multiple boards with the same stamped number, stack those pieces together.
- Stamps can be found on the flat surface of the boards or on the end of the boards.
- Allow yourself plenty of room - the wood pieces can take up a significant amount of space.
- Resin coming from the knots in the wood pieces is natural and does not affect the quality of the wood, but could cause yellowing around the knots.

NOTE: CARTONS ARE NOT ORGANIZED BY BOARD NUMBER.

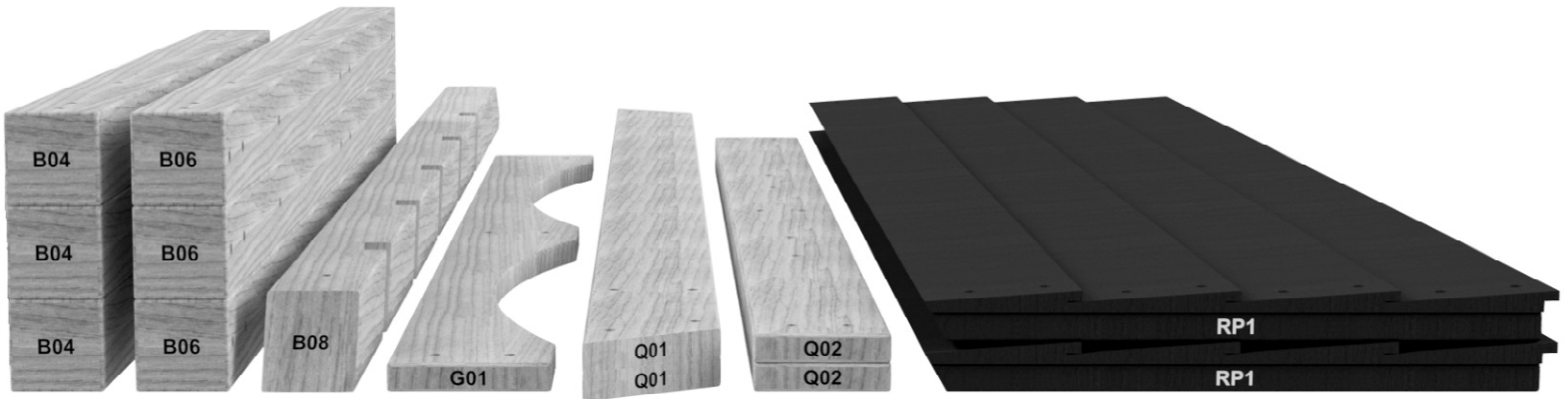

HARDWARE PARTS:

- We recommend that you have a separate table to organize the hardware.
- Hardware bags are printed with a seven-digit, alpha-numeric part number.
- You can organize your hardware by part number or group by hardware type (i.e. bolts, nuts, etc.).
- During assembly you only need to reference the last four digits of the number.



H100194 | BOLT WH
(x2) ↑ 5/16 x 2-1/2

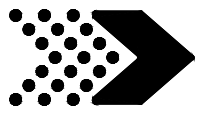

STEP 2

PRE-ASSEMBLY - TOOLS REQUIRED



Cordless Drill or
Electric Drill



Drill Attachments:
Phillips Head



1/8", 3/16", 3/8" & 7/16"
Drill Bits



Phillips Screw Driver



Open End Wrenches 1/2" & 9/16"



3/8" Drive Ratchet, 1/2" &
9/16" STD Sockets 1/2" & 9/16" Deep
Sockets



Claw Hammer



Rubber Mallet - Optional



Tape Measure

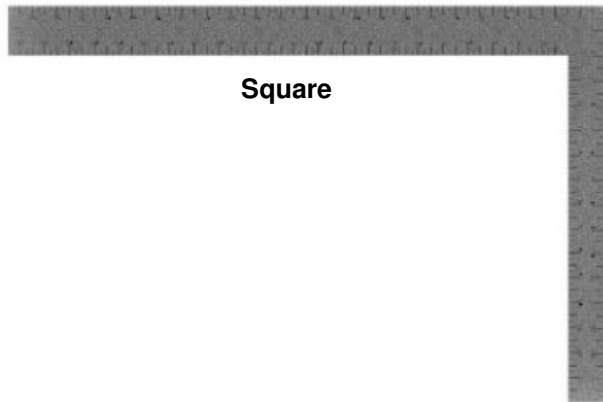

Square



Level 24"



STEP 3

PRE-ASSEMBLY - CHOOSE YOUR ASSEMBLY METHOD

There are several types of assembly instructions available to you.

1. Printed Assembly Manual included with your set
2. BILT APP - 3D interactive instructions
3. Combination of the Printed Manual and BILT APP (Note: Step numbers can differ between the two methods)

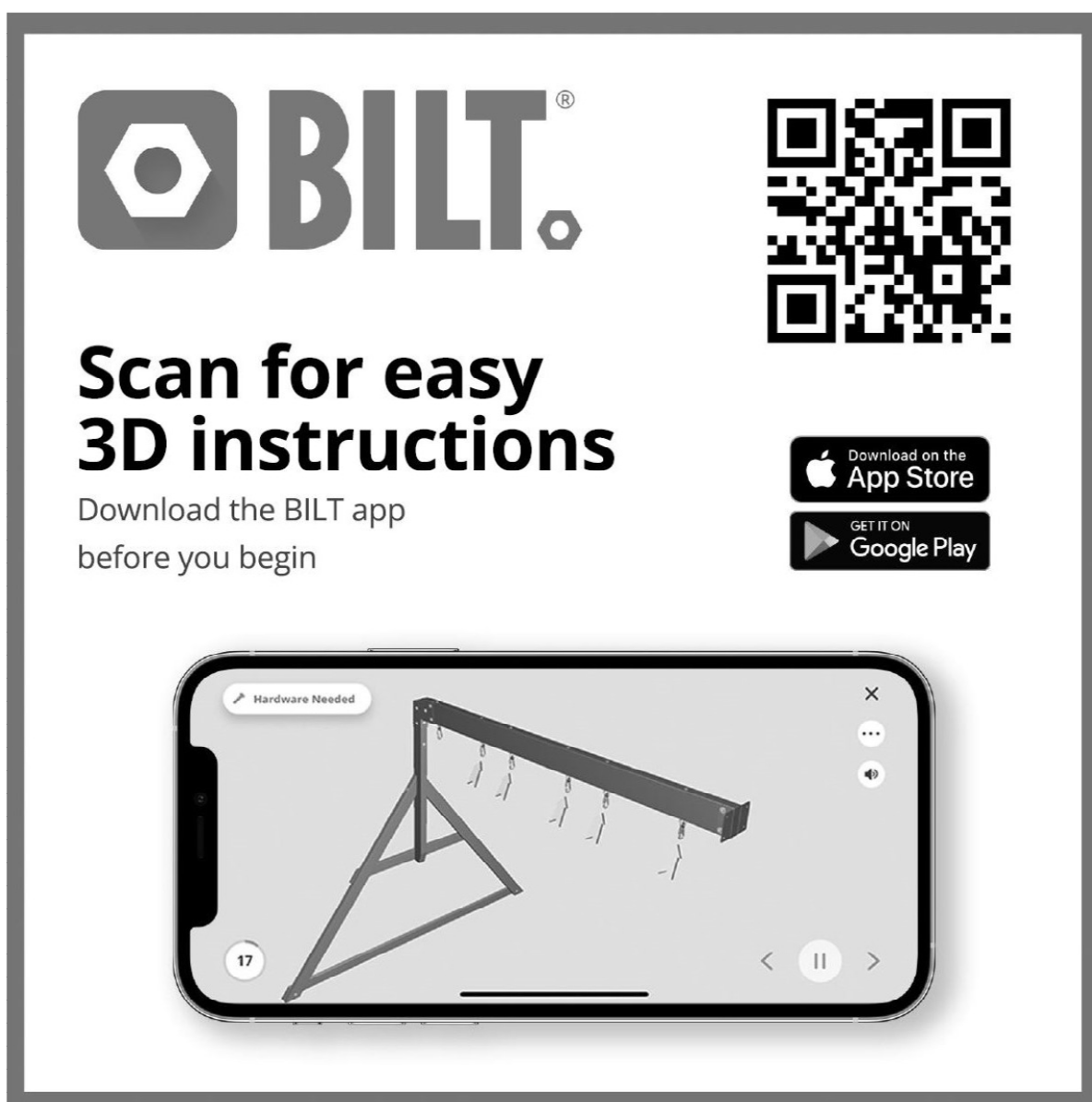

The advertisement features the BILT logo (a hexagon with a dot) and the text "BILT.®". To the right is a large QR code. Below the logo, the text reads "Scan for easy 3D instructions" and "Download the BILT app before you begin". There are two buttons: "Download on the App Store" and "GET IT ON Google Play". At the bottom, a smartphone screen displays a 3D assembly diagram of a metal frame with a horizontal bar and hanging weights. The screen includes a "Hardware Needed" label, a close button (X), a menu button (three dots), a volume icon, a page number "17", and navigation arrows.

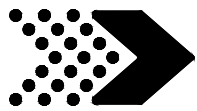

STEP 1

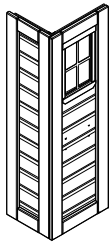

WP1 | LEFT FRONT CORNER PANEL - W2A03682
(x1) | LENGTH 38 9/16" (980)

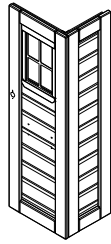

WP2 | RIGHT FRONT CORNER PANEL - W2A03685
(x1) | LENGTH 38 9/16" (980)

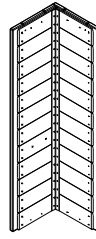

WP3 | LEFT REAR CORNER PANEL - W2A03688
(x1) | LENGTH 38 9/16" (980)

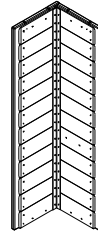

WP4 | RIGHT REAR CORNER PANEL - W2A03691
(x1) | LENGTH 38 9/16" (980)



NOTE:
POSITION WALL PANELS AS SHOWN BELOW. VERIFY THE CORRECT PANEL PLACEMENT BY CHECKING THE HOLE LOCATIONS AS SHOWN BELOW.

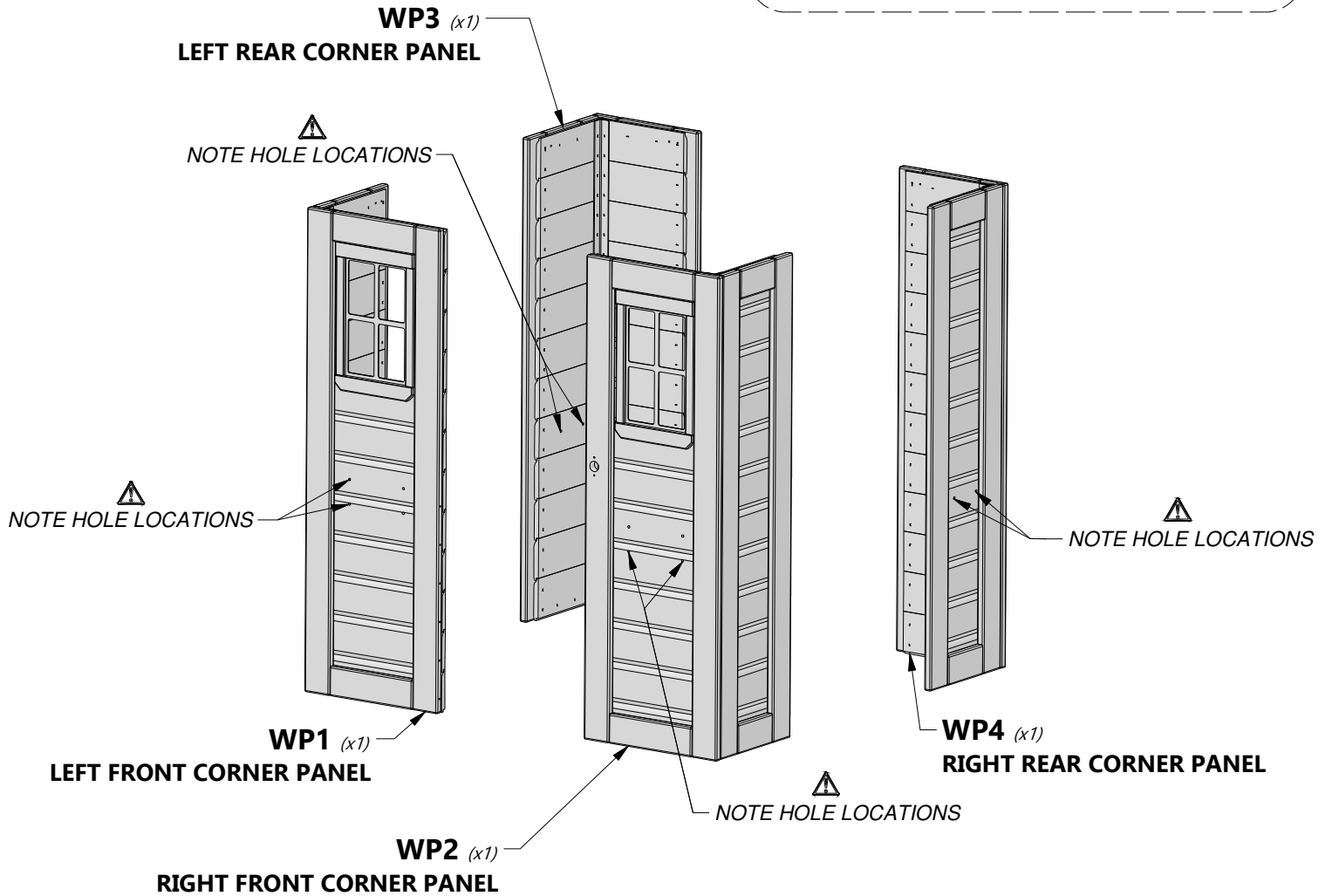

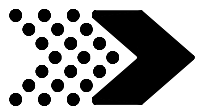

STEP 2

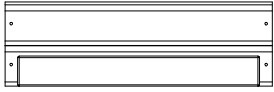

WP5 | LOWER CENTER WALL - W2A03694
(x1) | 1 1/2"x6 9/16"x20 7/8" (38x167x530)

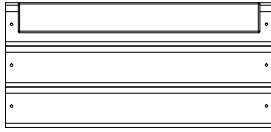

WP6 | UPPER CENTER WALL - W2A03695
(x1) | 1 1/2"x9 3/4"x20 7/8" (38x248x530)



H100085 | SCREW PFH
(x10) | 8x1



NOTE:

ALIGN PANELS AS SHOWN BELOW THEN PRE-DRILL PILOT HOLES USING AN 1/8" [3 mm] DRILL BIT, 1/2" [12 mm] DEEP FOR HARDWARE.

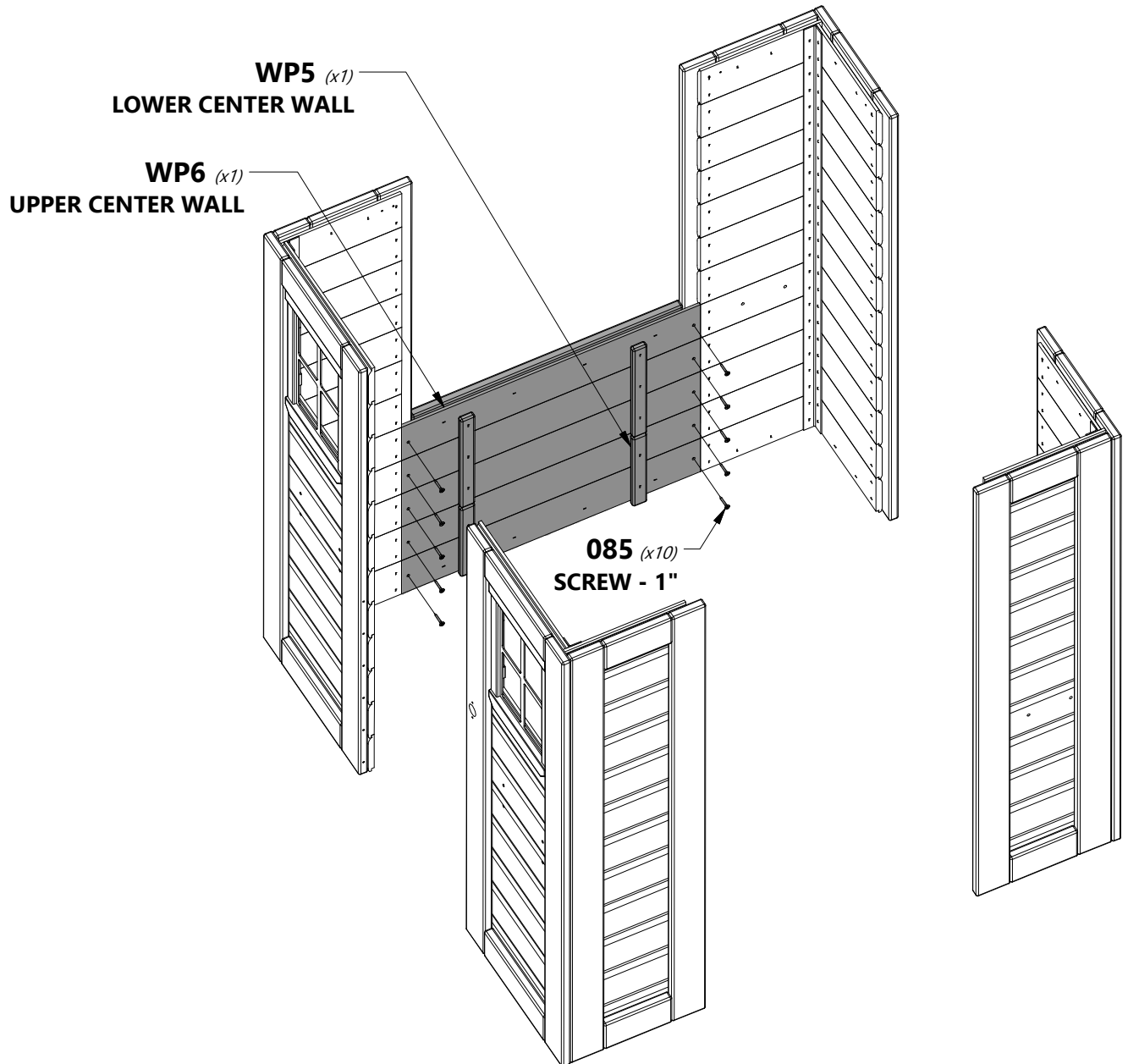

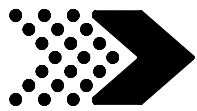

STEP 3

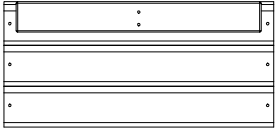

WP7 | UPPER REAR CENTER WALL - W2A03696
(x1) | 1 1/2"x9 3/4"x21 1/8" (38x248x536)

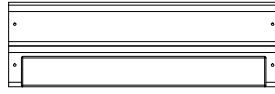

WP8 | LOWER REAR CENTER WALL - W2A03697
(x1) | 1 1/2"x6 9/16"x21 1/8" (38x167x536)



H100085 | SCREW PFH
(x10) | 8x1



NOTE:

ALIGN PANELS AS SHOWN BELOW THEN PRE-DRILL PILOT HOLES USING AN 1/8" [3 mm] DRILL BIT, 1/2" [12 mm] DEEP FOR HARDWARE.

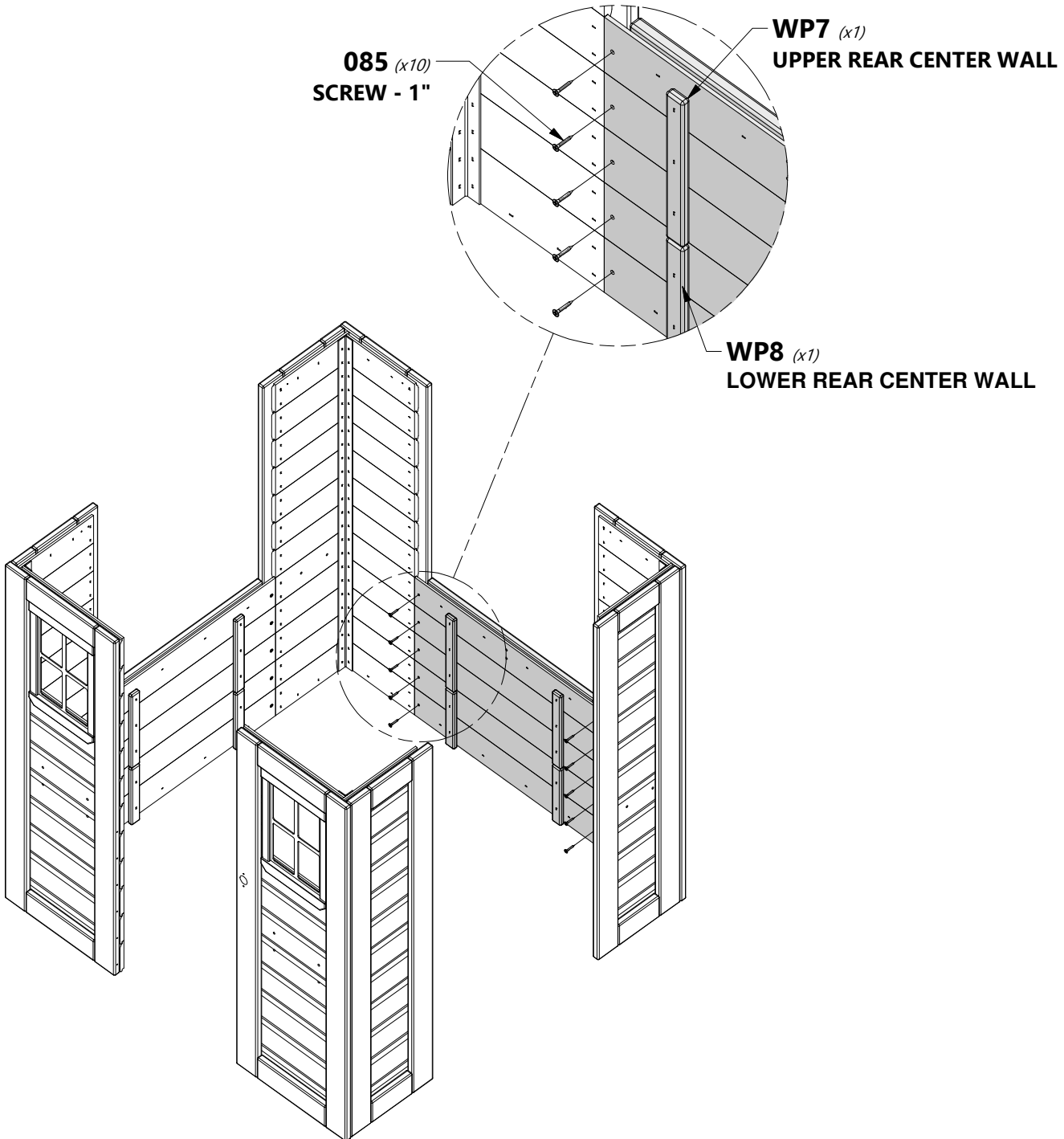

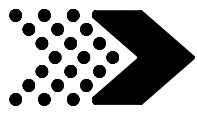

STEP 4

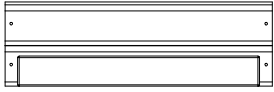

WP5 | LOWER CENTER WALL - W2A03694
(x1) | 1 1/2"x6 9/16"x20 7/8" (38x167x530)

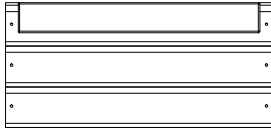

WP6 | UPPER CENTER WALL - W2A03695
(x1) | 1 1/2"x9 3/4"x20 7/8" (38x248x530)



H100085 | SCREW PFH
(x10) | 8x1



NOTE:

ALIGN PANELS AS SHOWN BELOW THEN PRE-DRILL PILOT HOLES USING AN 1/8" [3 mm] DRILL BIT, 1/2" [12 mm] DEEP FOR HARDWARE.

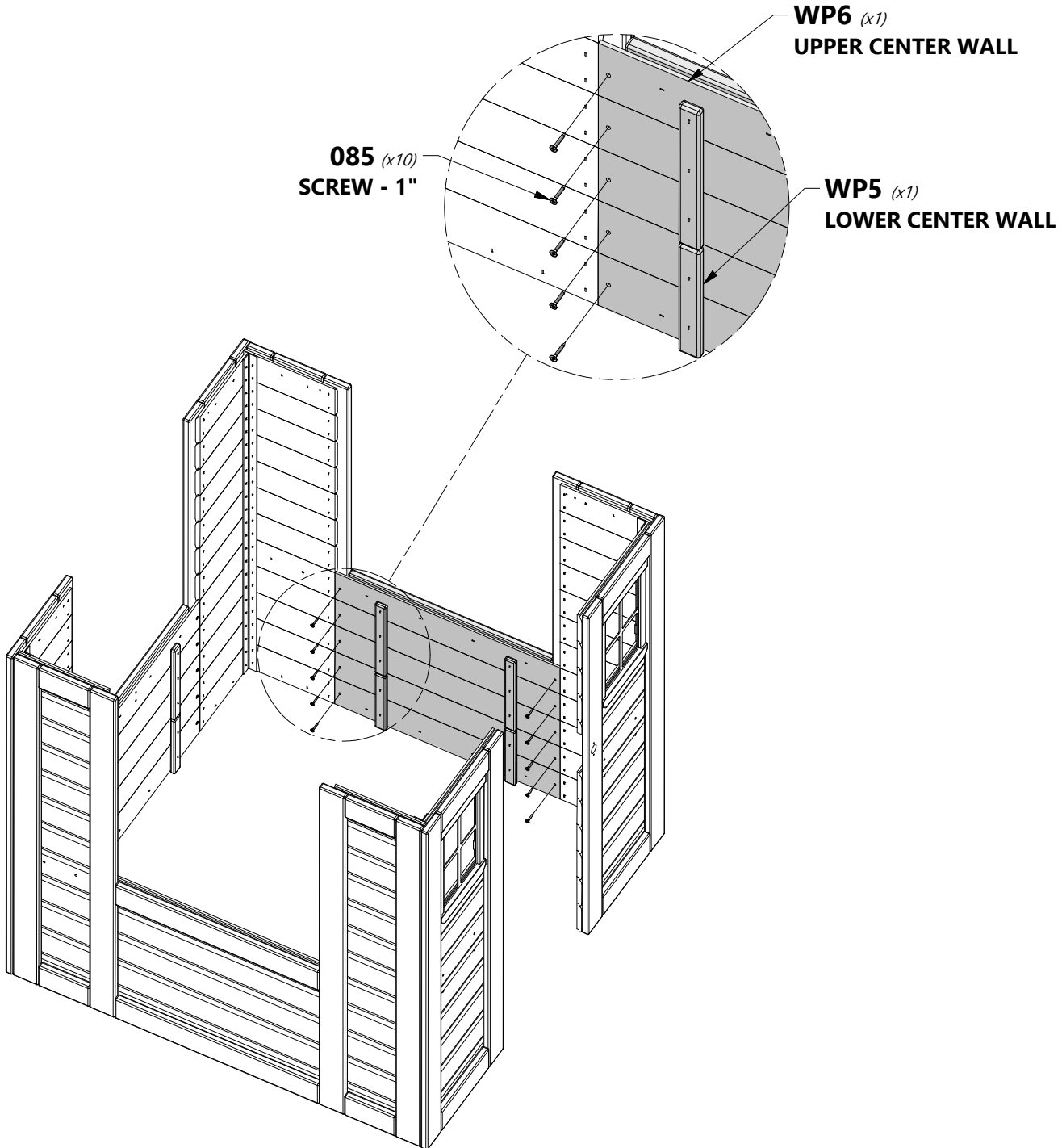

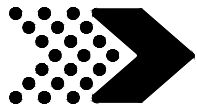

STEP 5

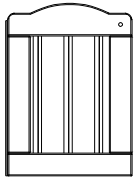

DP1 | DOOR ASSEMBLY - W2A03681
(x1) | 1 1/4"x13 1/8"x17 15/16" (32x334x456)



H100088 | SCREW PFH
(x6) | 8x1 1/8

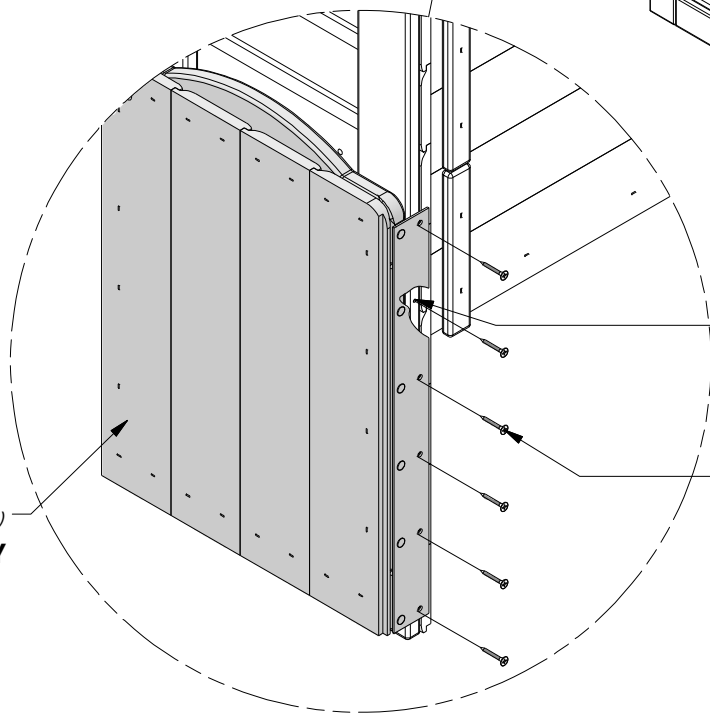
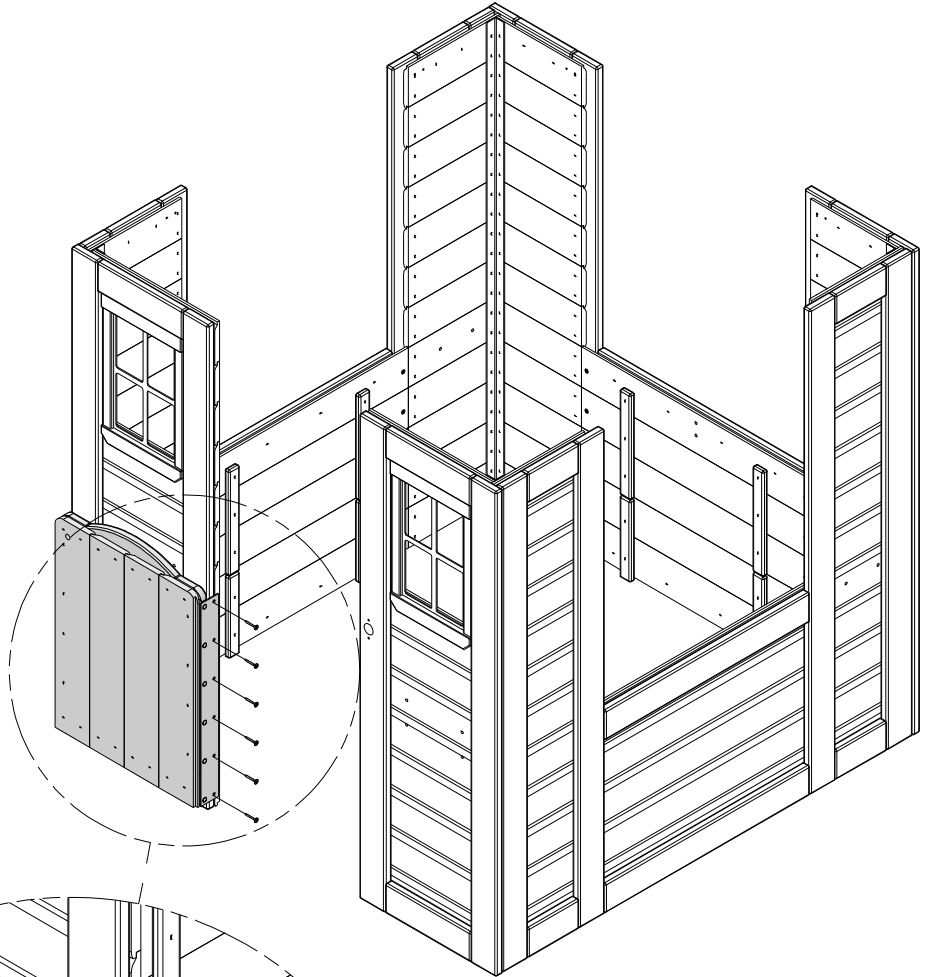
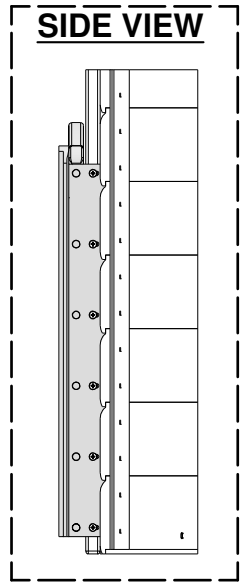

DP1 (x1)
DOOR ASSEMBLY



NOTE PILOT HOLES

088 (x6)
SCREW - 1 1/8"

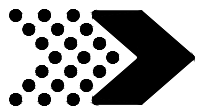

STEP 6



A4M00517 METAL TIE STRAP
(x1)



H100070 SCREW PWH
(x8) 8x3/4



TIP:
ALIGN TIE STRAP WITH PILOT HOLES AND ASSEMBLE AS SHOWN.

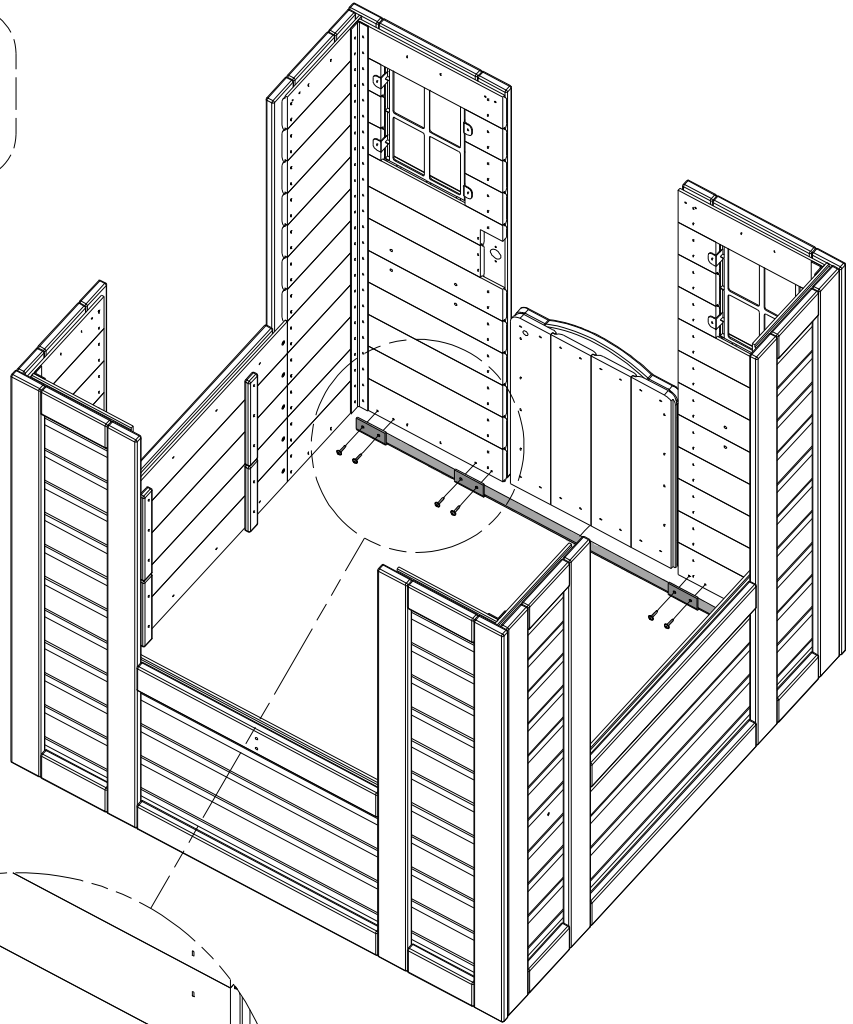

 NOTE PILOT HOLES

070 *(x8)*
SCREW - 8x3/4"

517 *(x1)*
METAL TIE STRAP

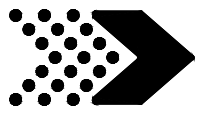

STEP 7

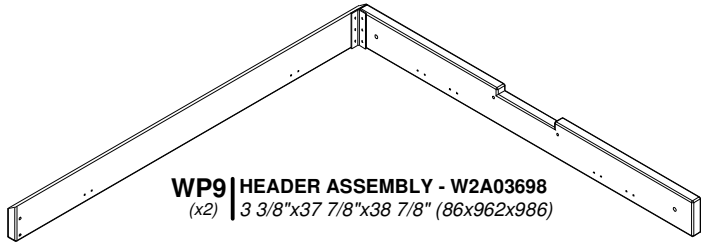

WP9 | HEADER ASSEMBLY - W2A03698
(x2) | 3 3/8"x37 7/8"x38 7/8" (86x962x986)

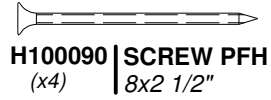

H100090 | SCREW PFH
(x4) | 8x2 1/2"



NOTE:

REST HEADER ASSEMBLIES ON THE WALL PANELS AND ASSEMBLY AS SHOWN.

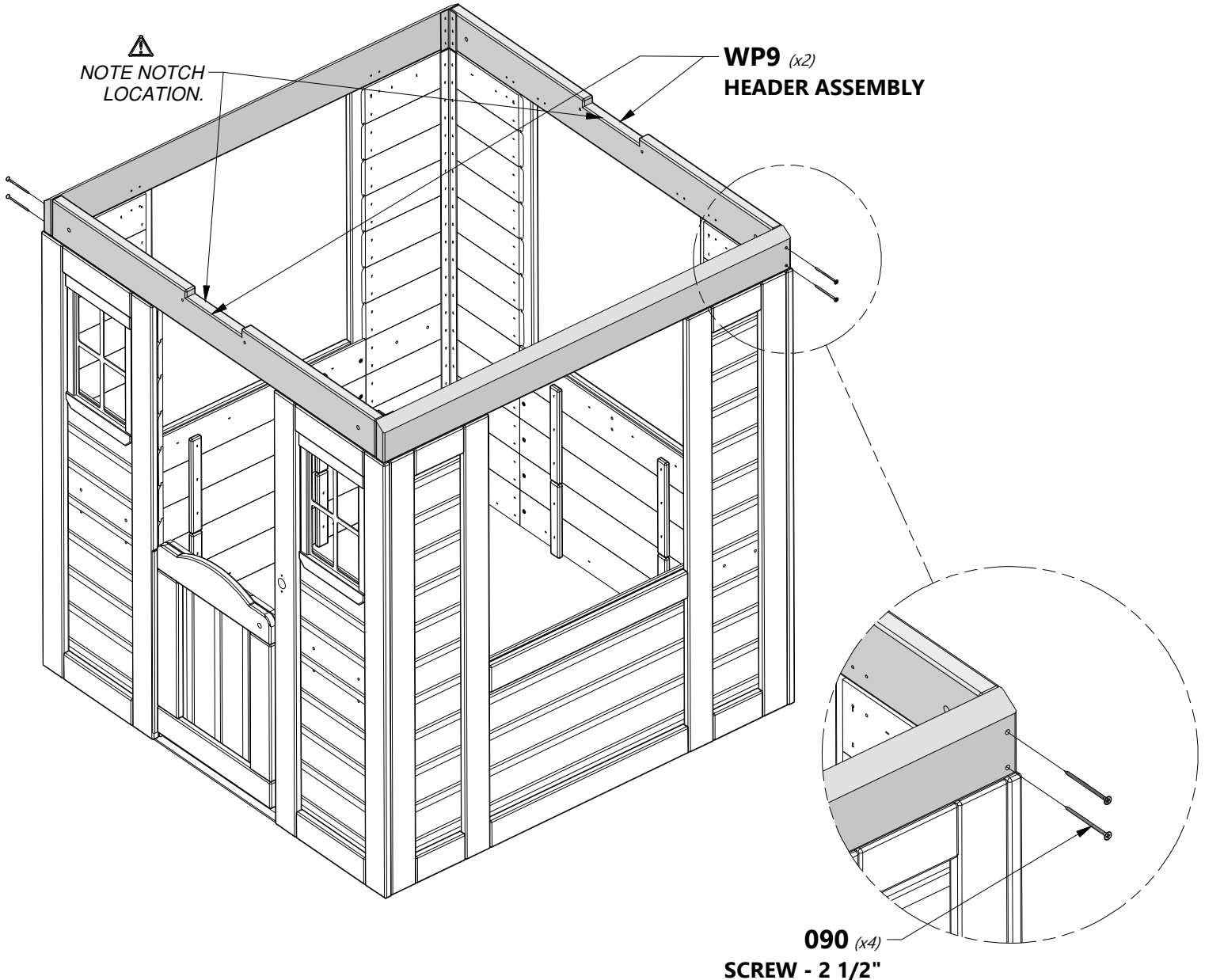

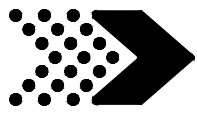

STEP 8

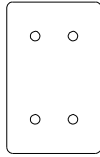

N4 | TIE STRAP - W4L17075
(x8) | 5/8"x2"x3 1/8" (16x50x80)



H100087 | SCREW PFH
(x32) | 8x1 1/4

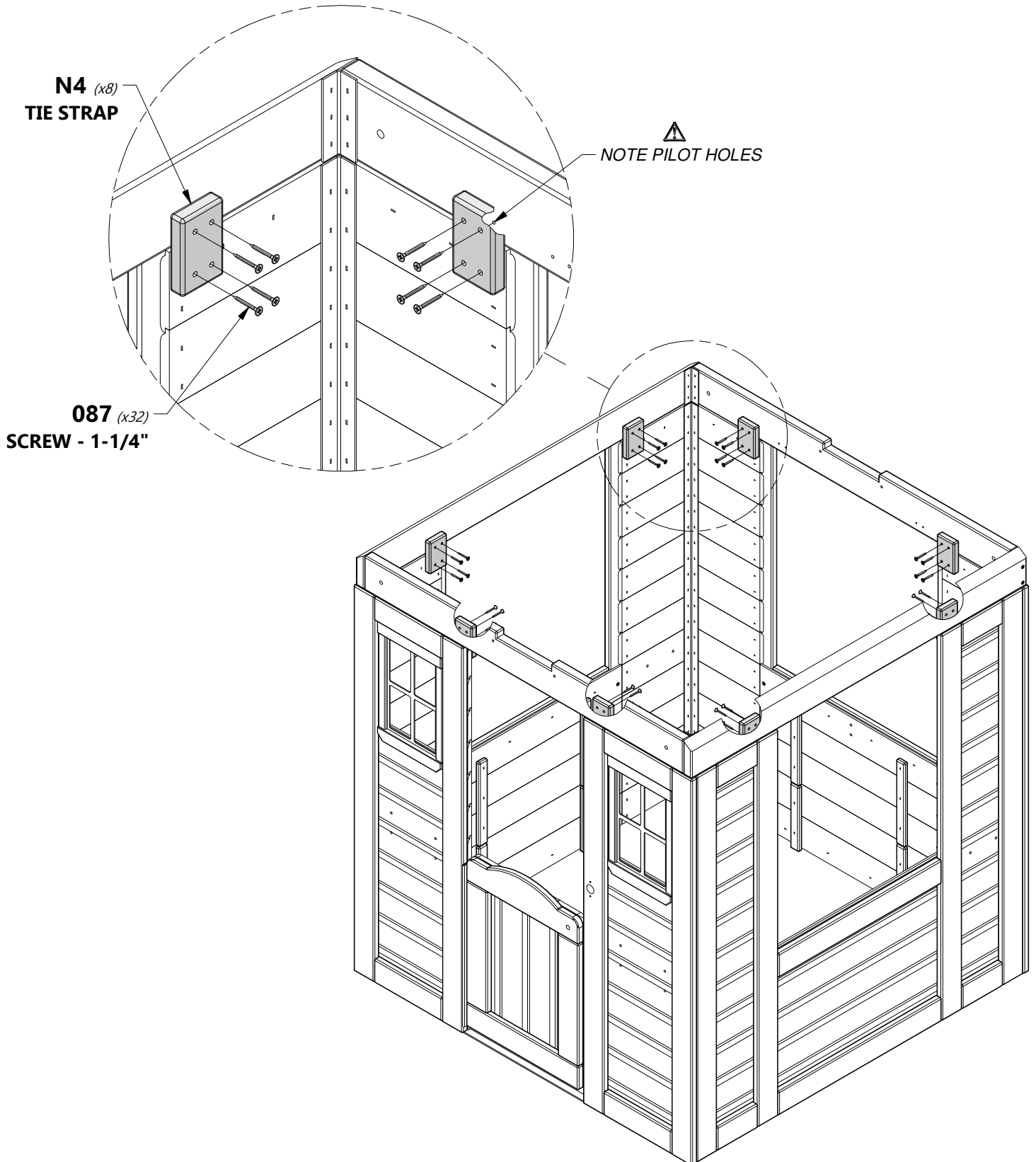

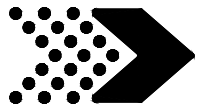

STEP 9

L1 | GABLE BOARD - W4L17070
(x4) | 5/8"x4 3/8"x25 3/8" (16x112x643)

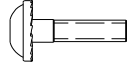

H100137 | BOLT WH
(x4) | 1/4x1



H100138 | WASHER LOCK EXT
(x4) | 6x15



H100139 | WASHER LOCK EXT
(x4) | 8x15

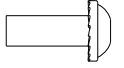

H100140 | NUT BARREL WH
(x4) | 1/4x7/8

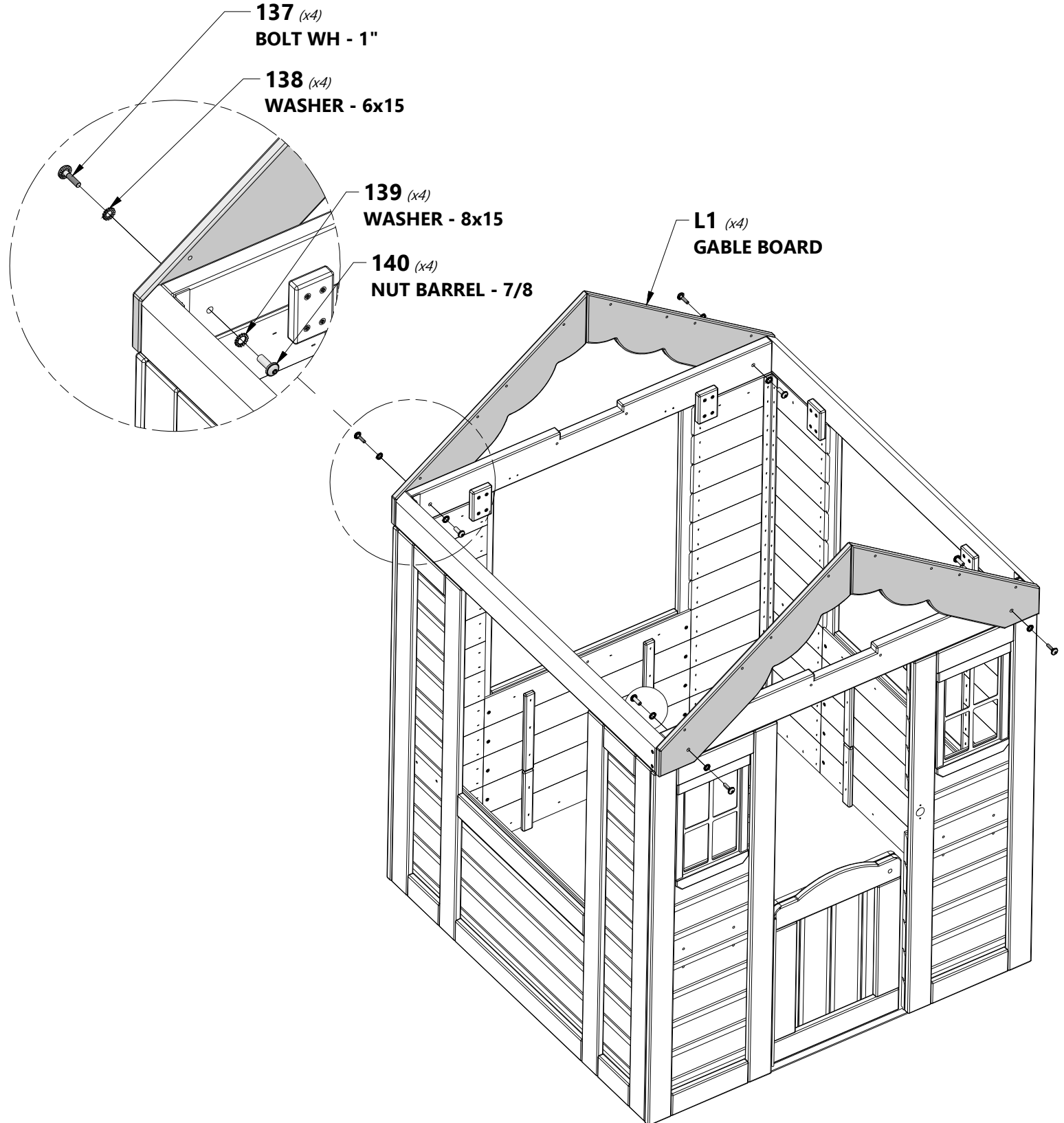

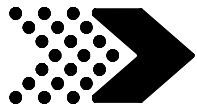

STEP 10

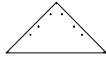

K1 | TRIANGLE SUNBURST - W4L17069
(x2) | 5/8"x5 1/4"x10 3/8" (16x134x265)



N5 | SUNBURST LEG - W4L17076
(x2) | 5/8"x2 3/8"x9 7/8" (16x60x250)



N6 | SUNBURST LEG - W4L17077
(x4) | 5/8"x2 3/8"x8 1/4" (16x60x210)



H100088 | SCREW PFH
(x20) | 8x1 1/8



H100086 | SCREW PFH
(x4) | 8x1 1/2

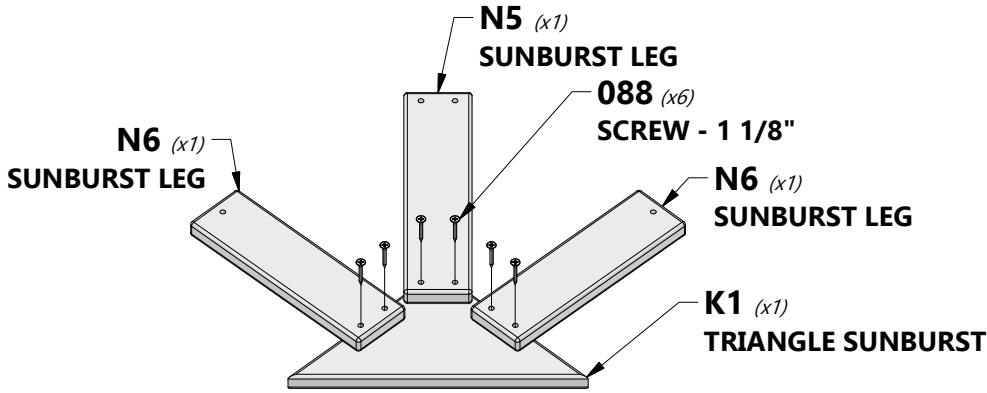

SUNBURST ASSEMBLY

⚠ NOTE: REPEAT STEP TO COMPLETE TWO SUNBURST ASSEMBLIES.

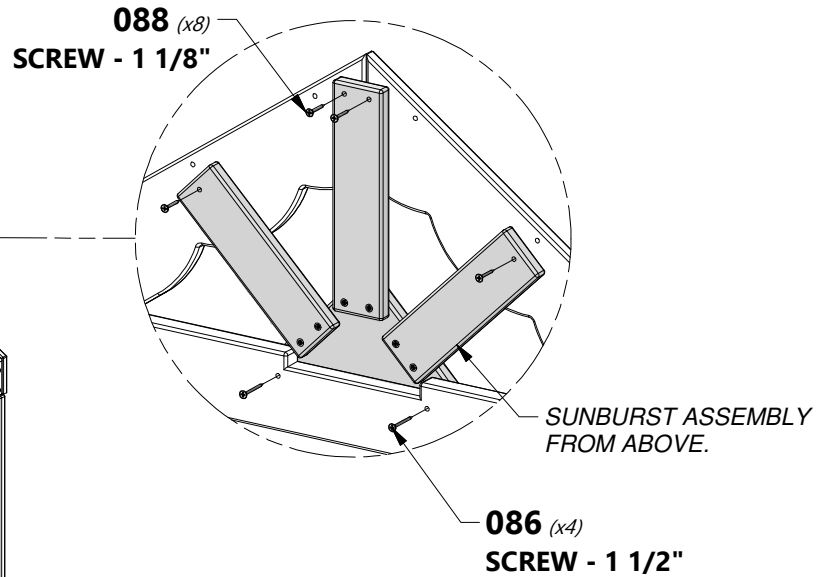
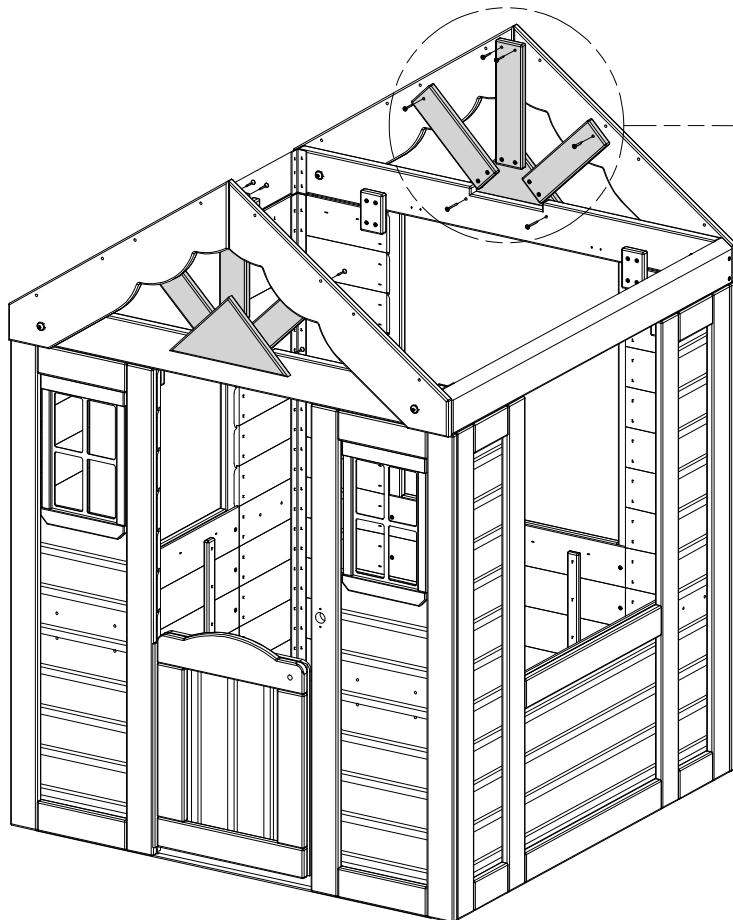

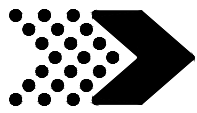

STEP 11

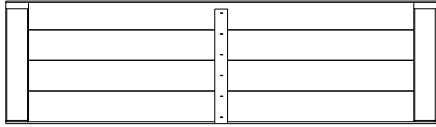

RP2 | UPPER ROOF PANEL - W2A02983
(x2) | 1 3/8"x12 3/4"x44 7/8" (35x324x1140)



H100086 | SCREW PFH
(x8) | 8x1 1/2

REPEAT ON OPPOSITE END

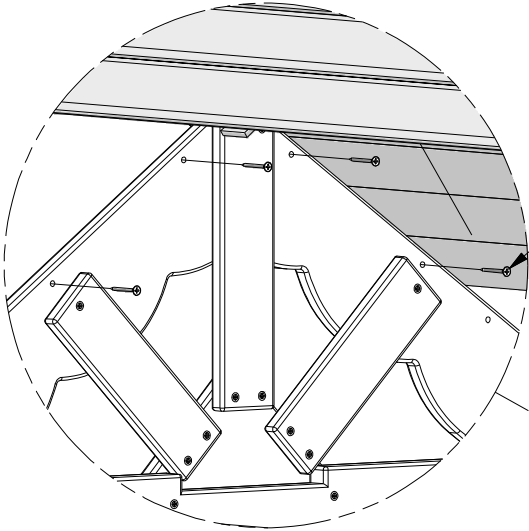

086 (x4)
SCREW - 1 1/2"

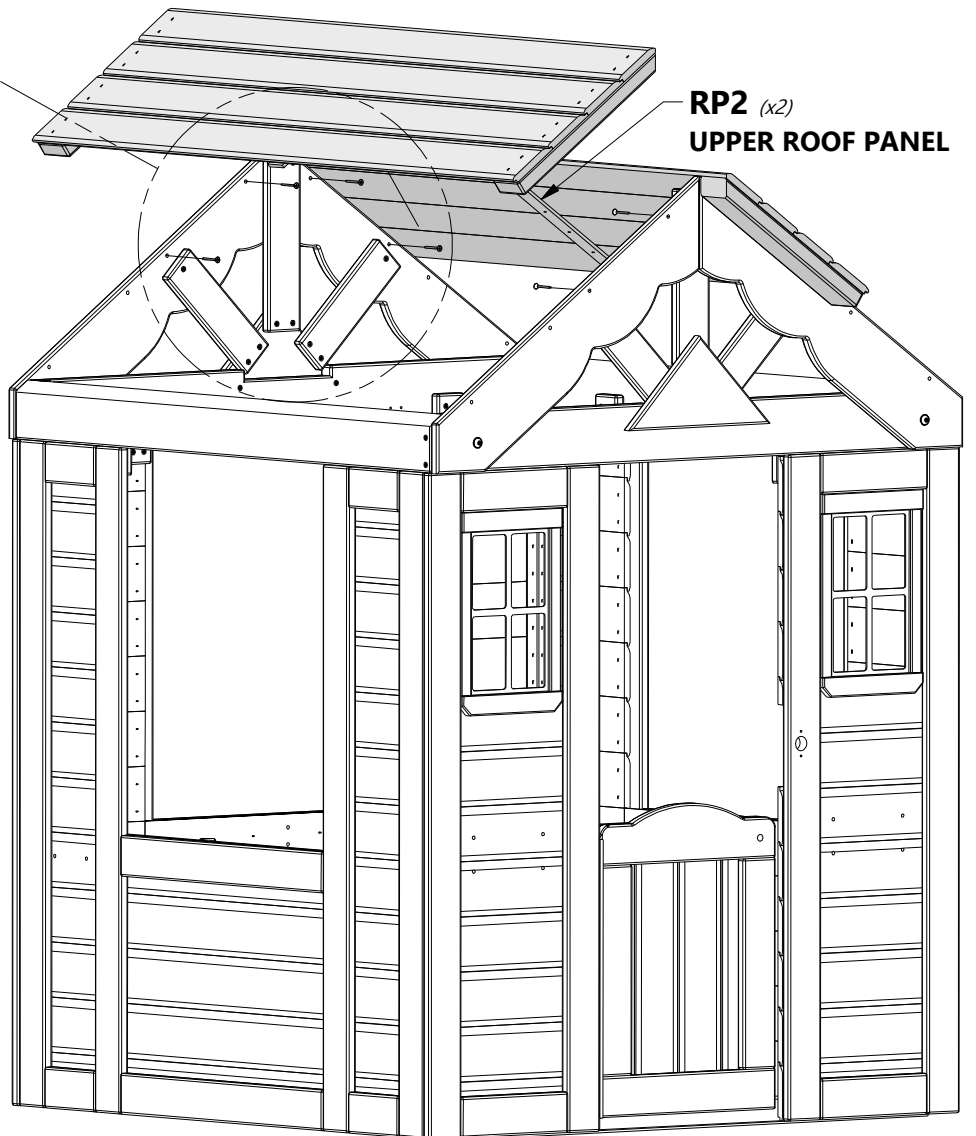

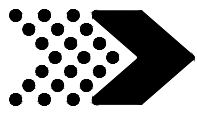

STEP 12

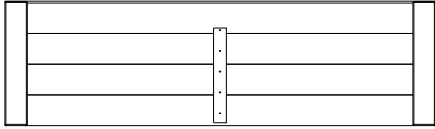

RP1 | LOWER ROOF PANEL - W2A02982
(x2) | 1 3/8"x13"x44 7/8" (35x329x1140)



H100086 | SCREW PFH
(x8) | 8x1 1/2

REPEAT ON OPPOSITE END

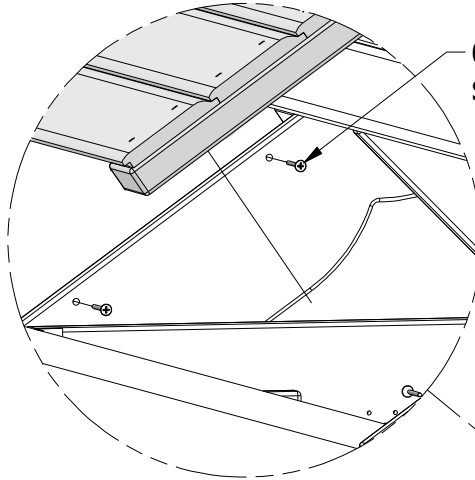

086 (x4)
SCREW - 1 1/2"

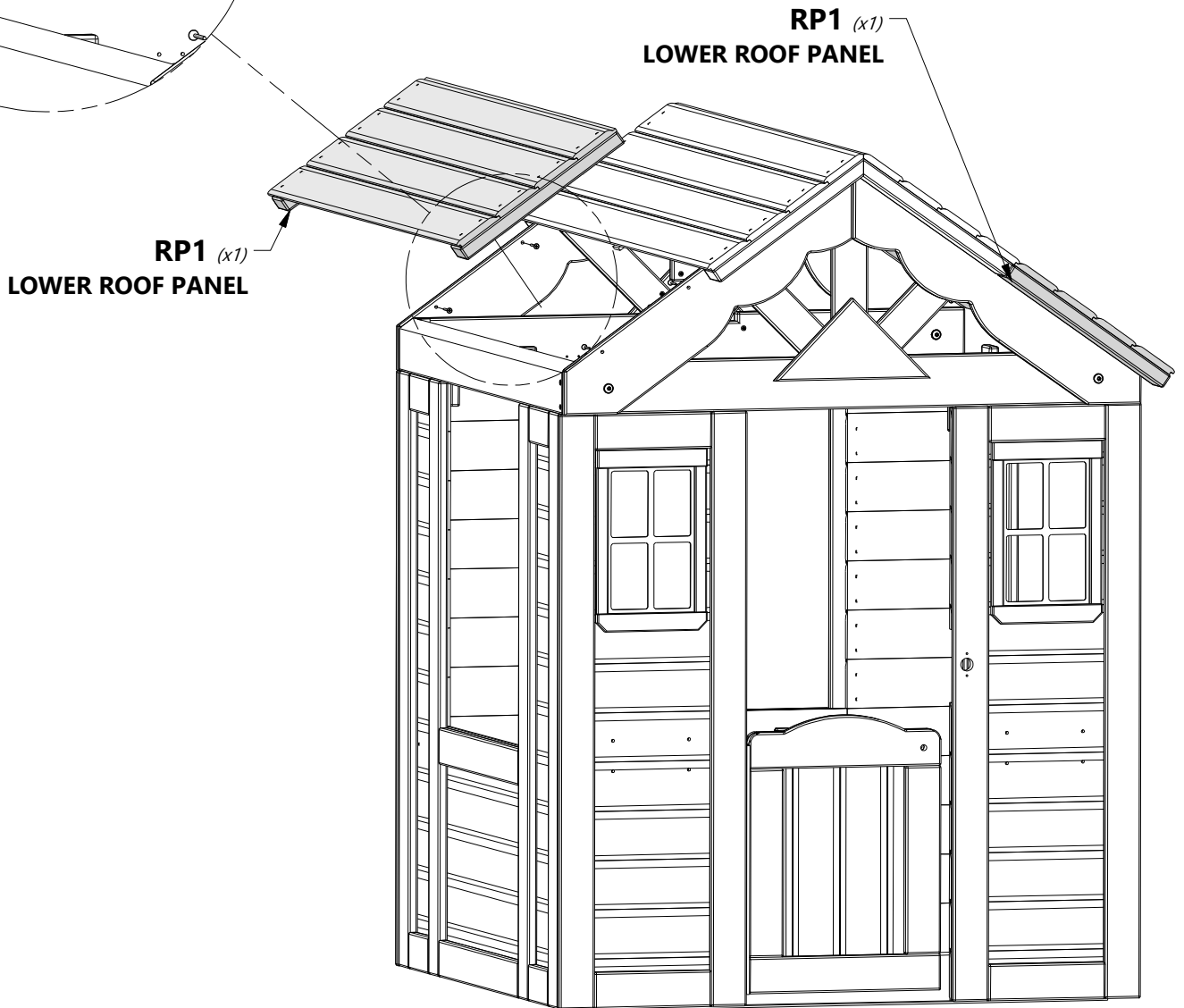

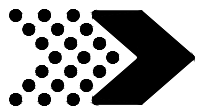

STEP 13



N1 | SIDE WINDOW SHELF - W4L17072
(x1) | 5/8"x2 3/8"x18 7/8" (16x60x479)



H100087 | SCREW PFH
(x2) | 8x1 1/4

INSIDE VIEW

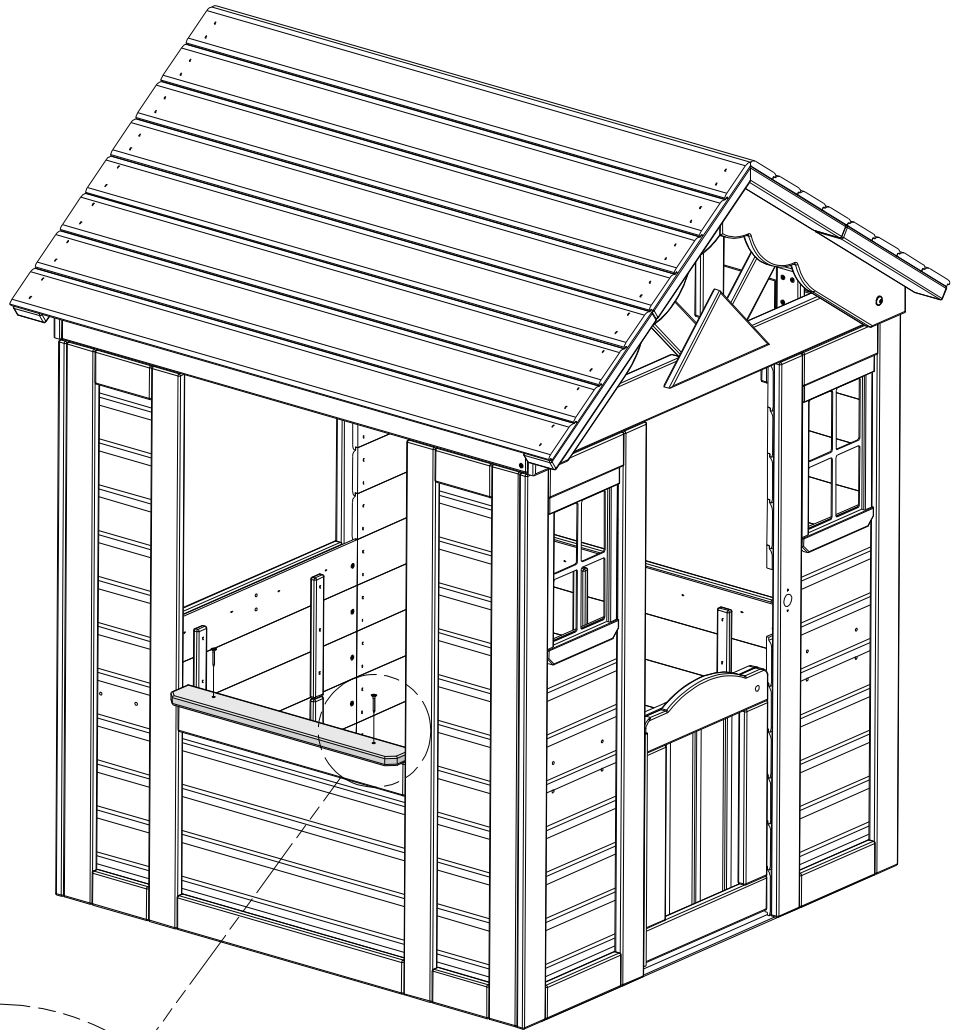
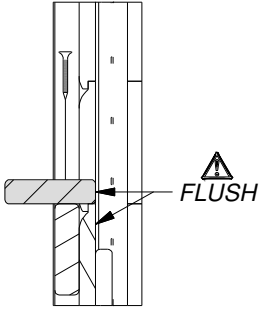

087 (x2)
SCREW - 1-1/4"

N1 (x1)
SIDE WINDOW SHELF

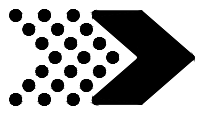

STEP 14



N2 | REAR WINDOW SHELF - W4L17073
(x1) | 5/8"x2 3/8"x19 1/8" (16x60x485)



H100087 | SCREW PFH
(x2) | 8x1 1/4

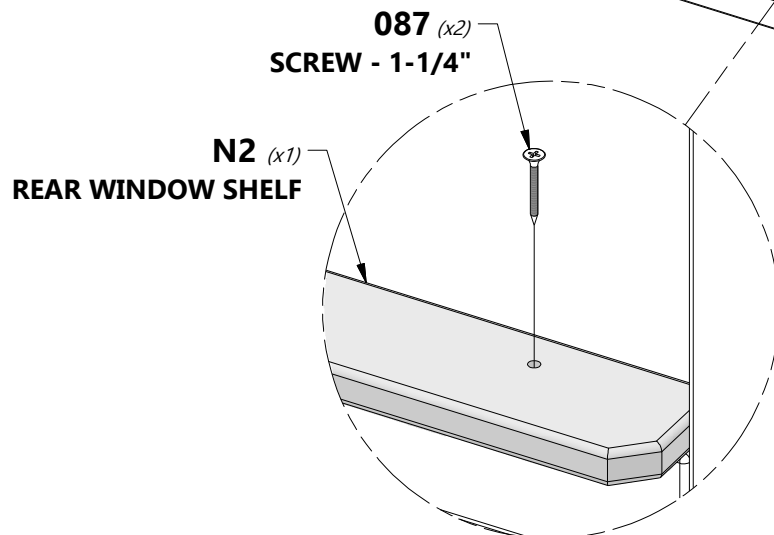
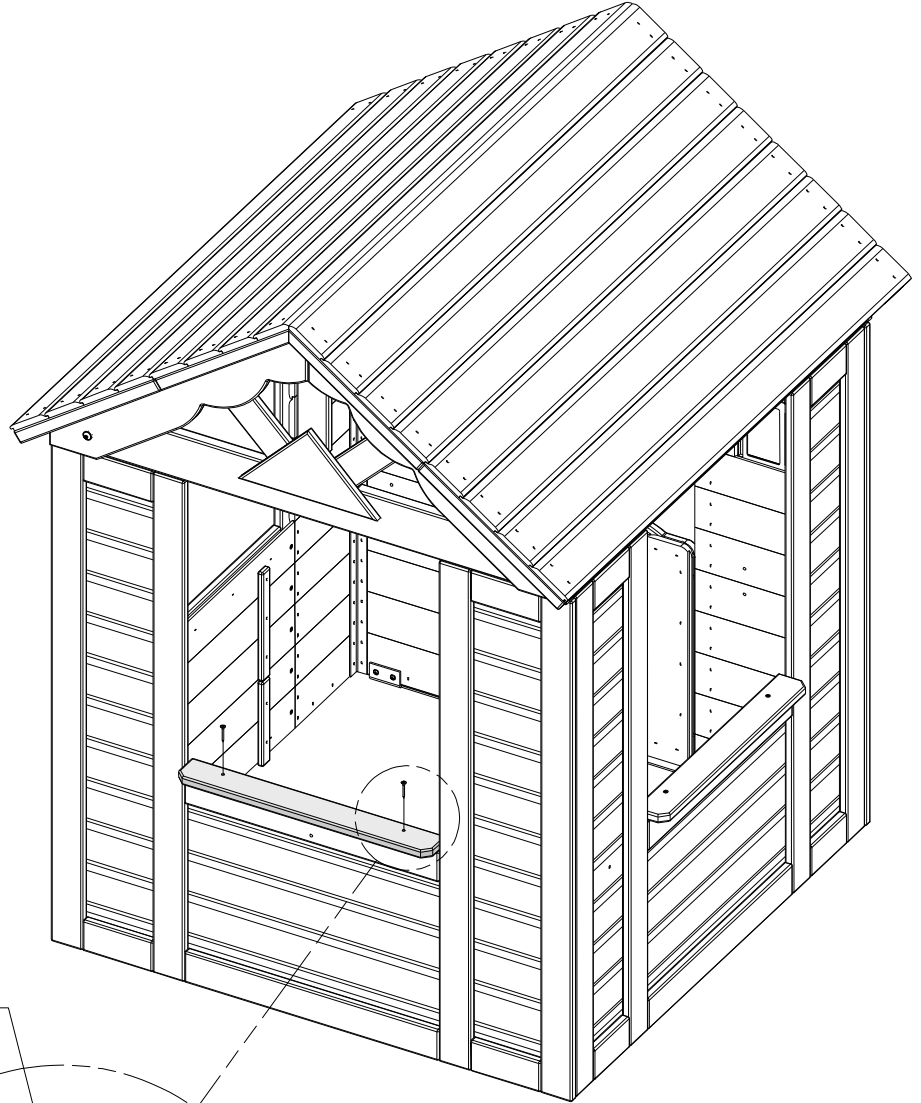
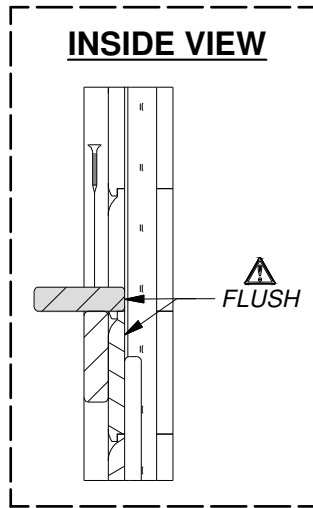

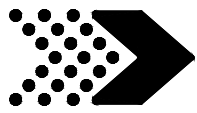

STEP 15



N1 | SIDE WINDOW SHELF - W4L17072
(x1) | 5/8"x2 3/8"x18 7/8" (16x60x479)



H100087 | SCREW PFH
(x2) | 8x1 1/4

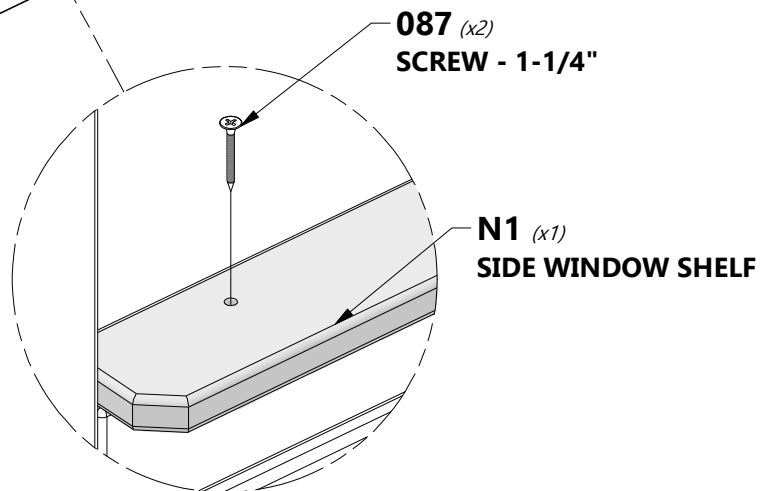
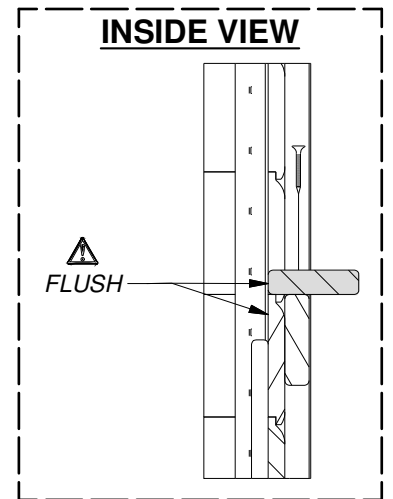
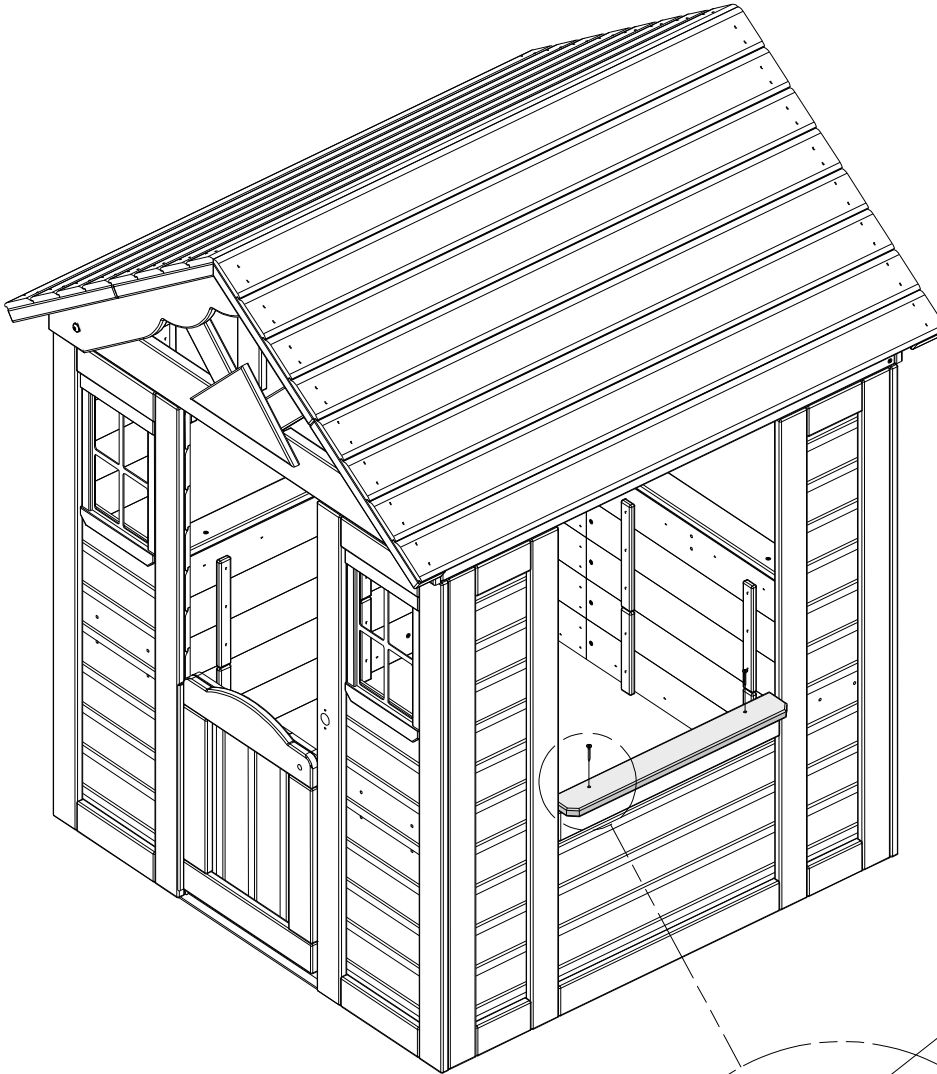

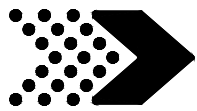

STEP 16

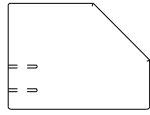

D1 | COUNTER TOP SUPPORT - W4L17067
(x1) | 1 3/8"x4 3/8"x5 7/8" (36x112x150)

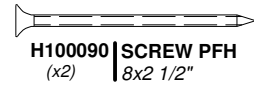

H100090 | SCREW PFH
(x2) | 8x2 1/2"

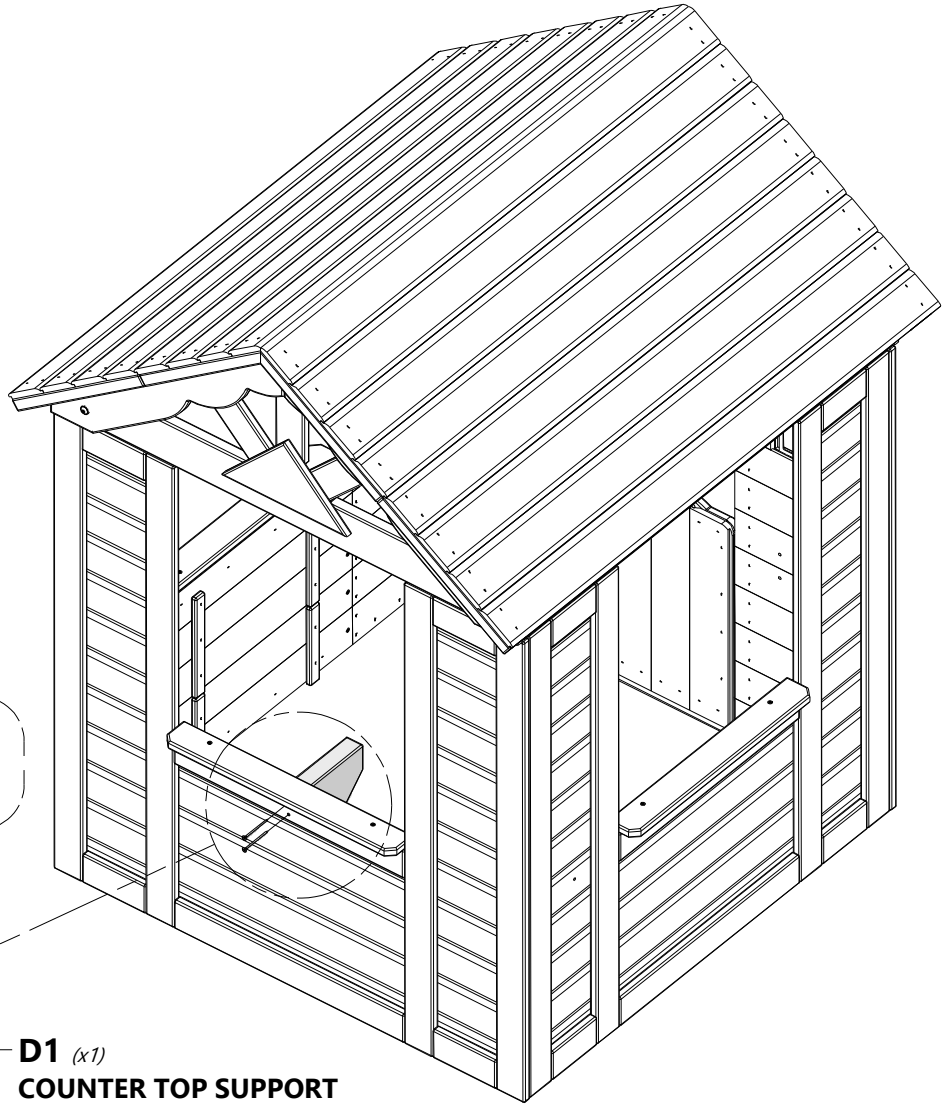

NOTE:
ALIGN PILOT HOLES IN D1 AND ASSEMBLE.

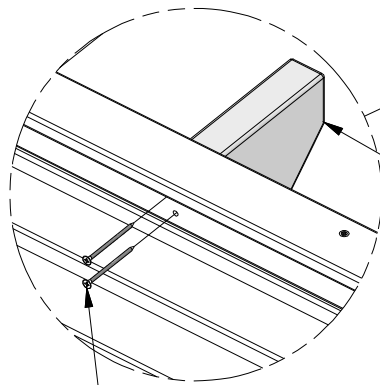

090 (x2)
SCREW - 2 1/2"

D1 (x1)
COUNTER TOP SUPPORT

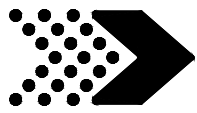

STEP 17



J1 | COUNTER TOP SUPPORT - W4L17068
(x2) | 1"x2 3/8"x5 7/8" (24x60x150)



H100087 | SCREW PFH
(x4) | 8x1 1/4

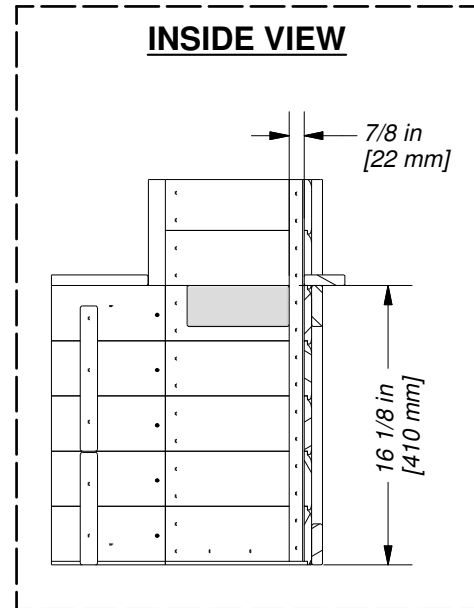
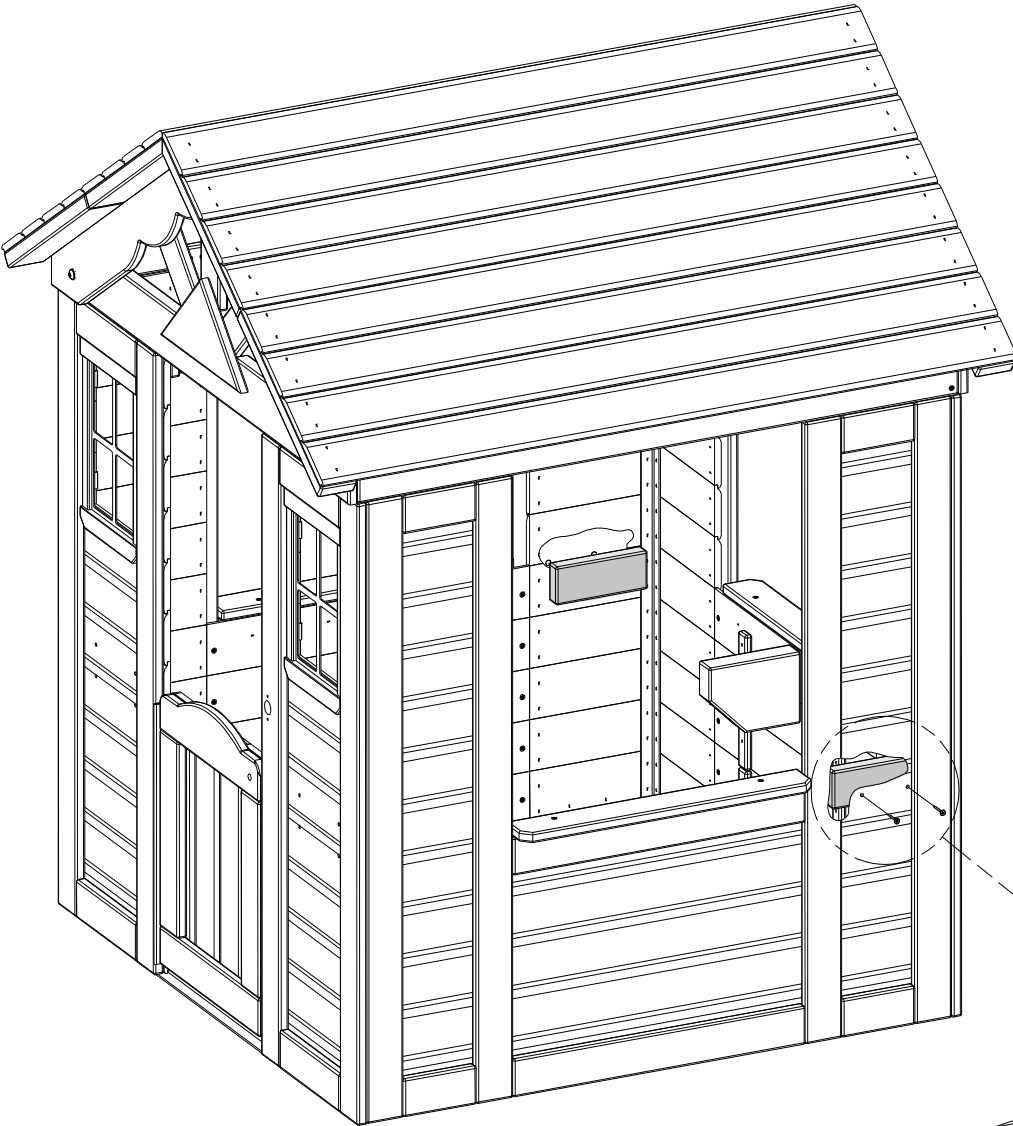

J1 (x1)
COUNTER TOP SUPPORT

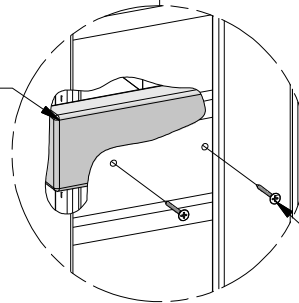

087 (x2)
SCREW - 1-1/4"

REPEAT ON OPPOSITE WALL

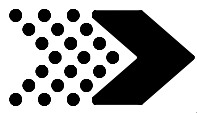

STEP 18

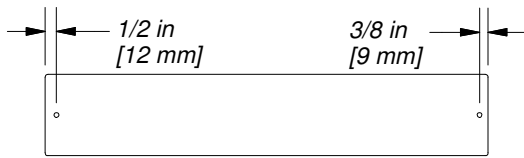

M1 | COUNTER TOP - W4L17071
(x4) | 5/8"x3 3/8"x18 1/2" (16x86x469)



H100087 | SCREW PFH
(x8) | 8x1 1/4

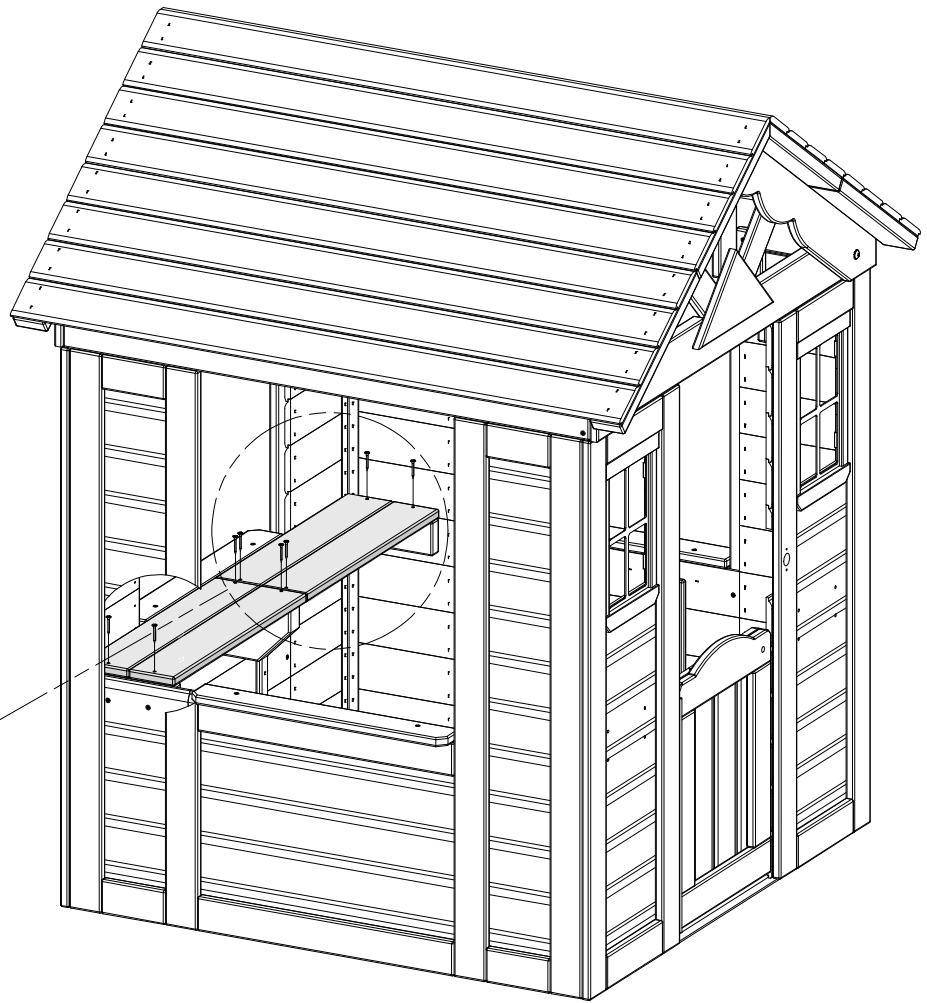
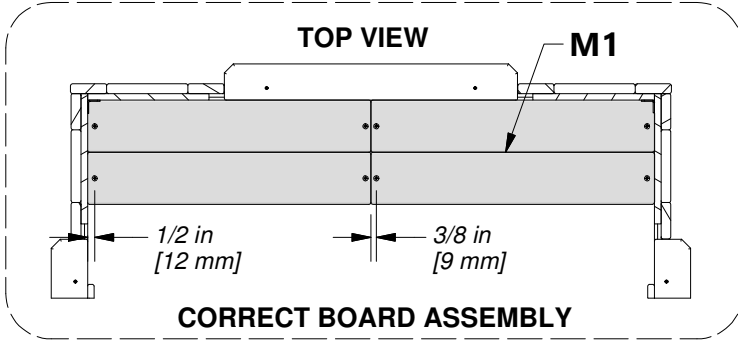

087 (x8)
SCREW - 1-1/4"

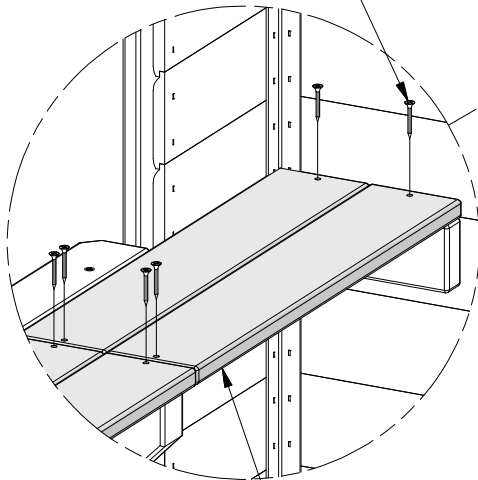

M1 (x4)
COUNTER TOP

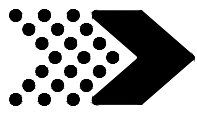

STEP 19

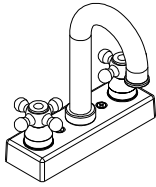

A6P00024
(x1) | **FAUCET KIT**



H100086 | **SCREW PFH**
(x2) | 8x1 1/2

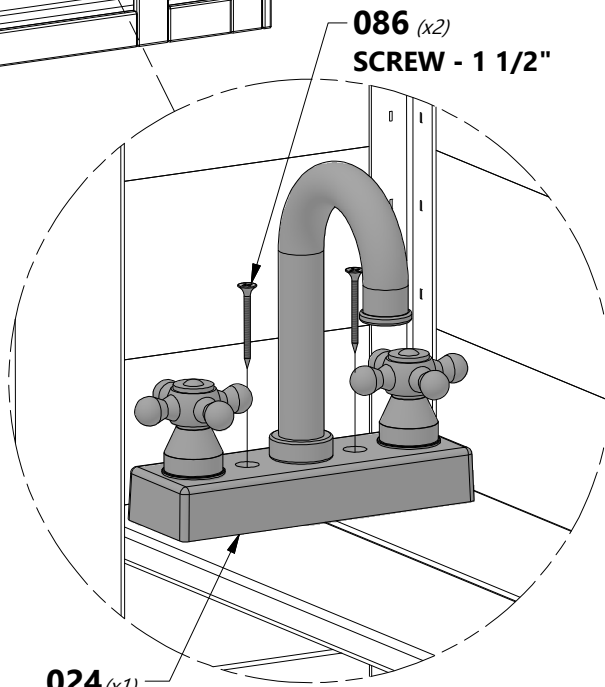
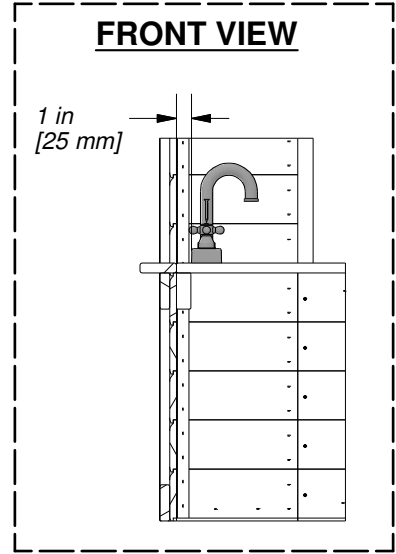
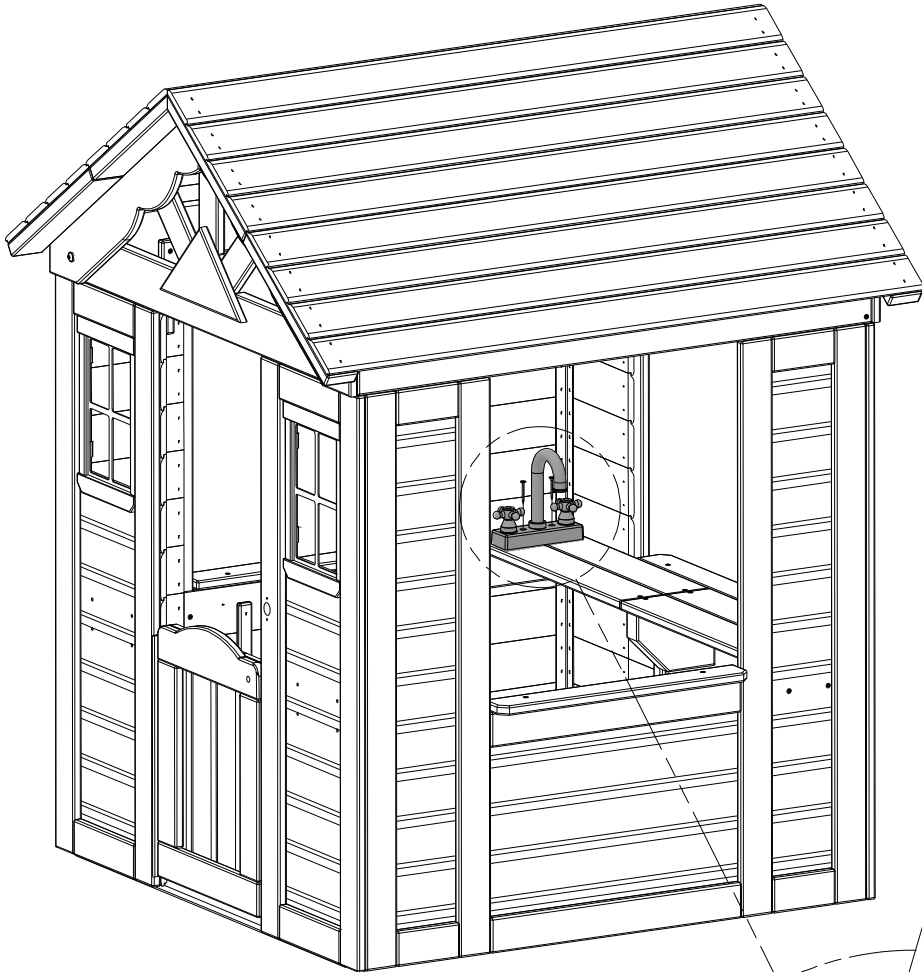

086 (x2)
SCREW - 1 1/2"

024 (x1)
FAUCET KIT

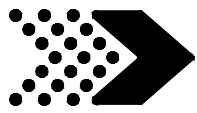

STEP 20

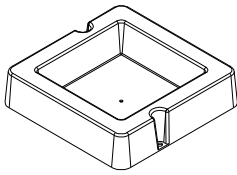

A6P00032 | SURFACE MOUNT BASIN
(x1)



H100128 | SCREW PWH
(x2) 8x5/8

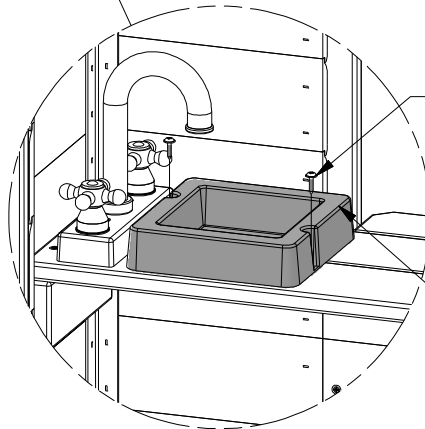
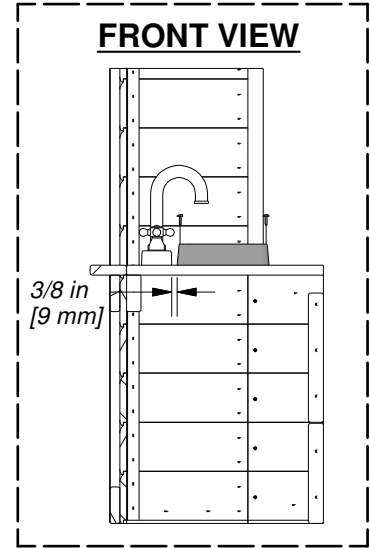
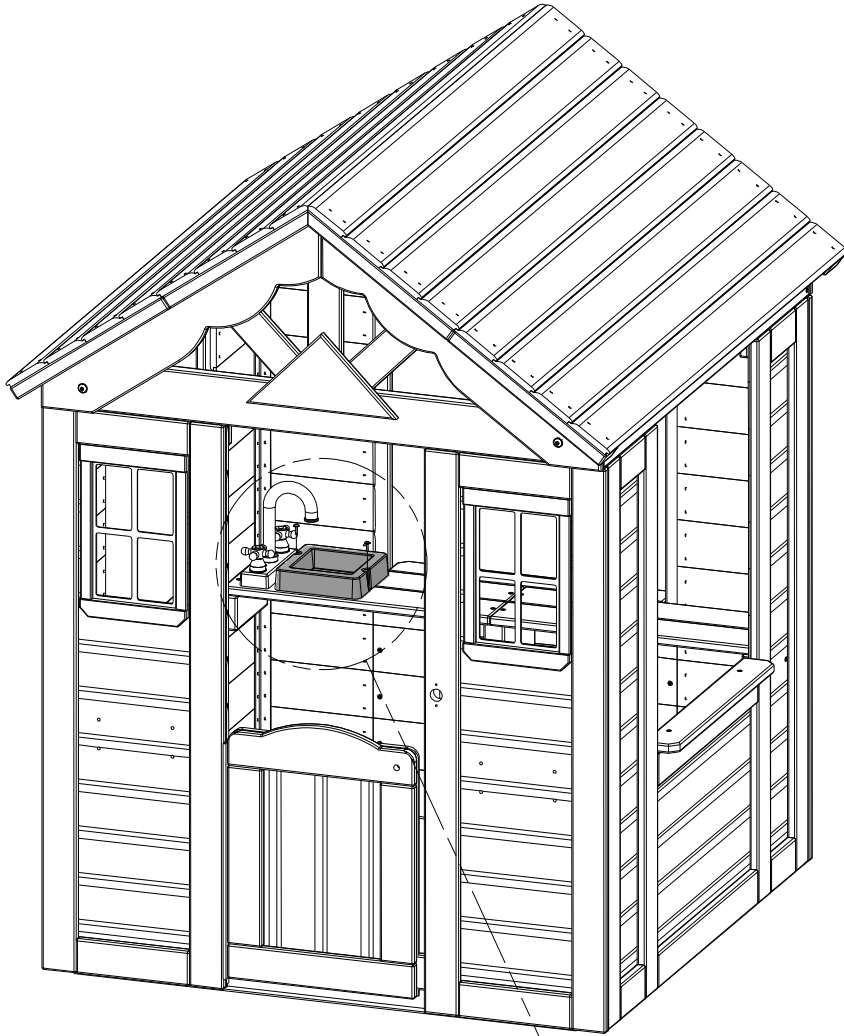

128 (x2)
SCREW - 5/8

032 (x1)
SURFACE MOUNT BASIN

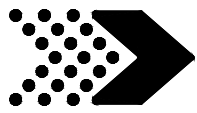

STEP 21

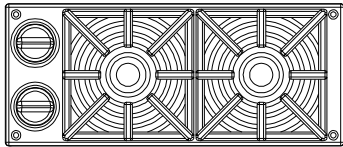

A6P00025 | STOVE KIT
(x1)



H100088 | SCREW PFH
(x4) | 8x1 1/8

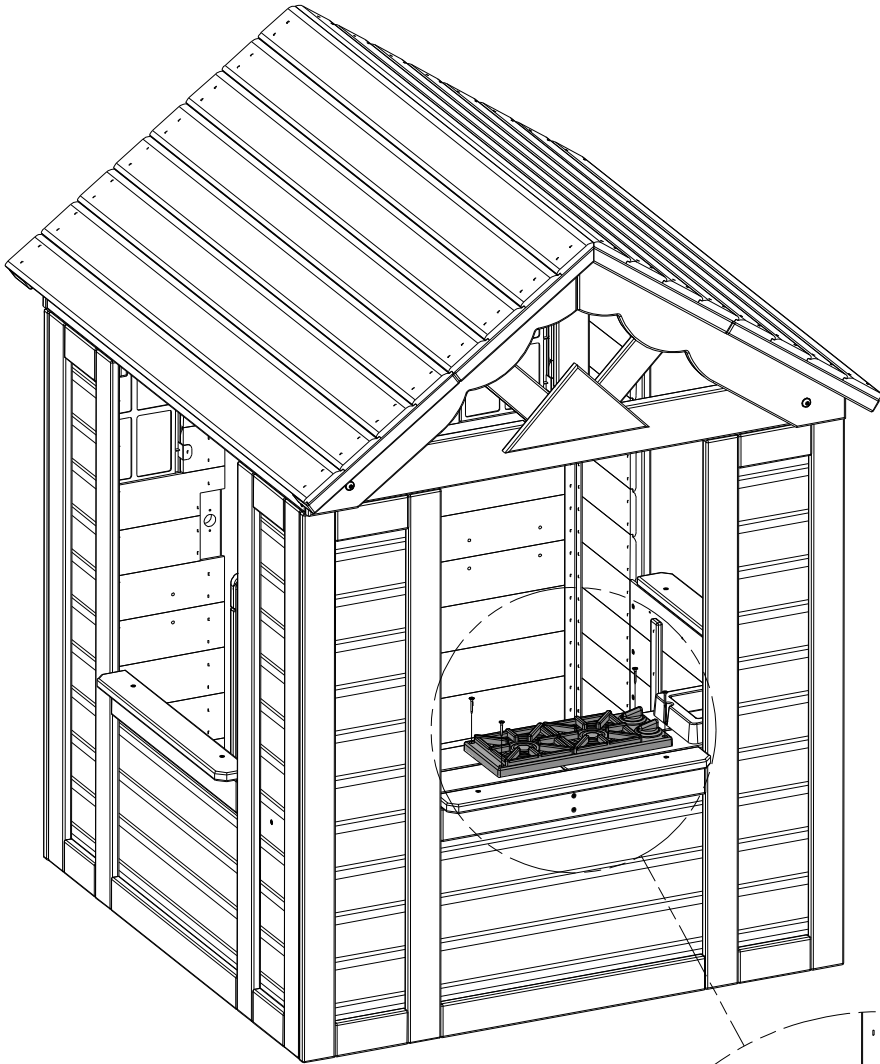

088 (x4)
SCREW - 1 1/8"

025 (x1)
STOVE KIT

1 1/8 in
[29 mm]

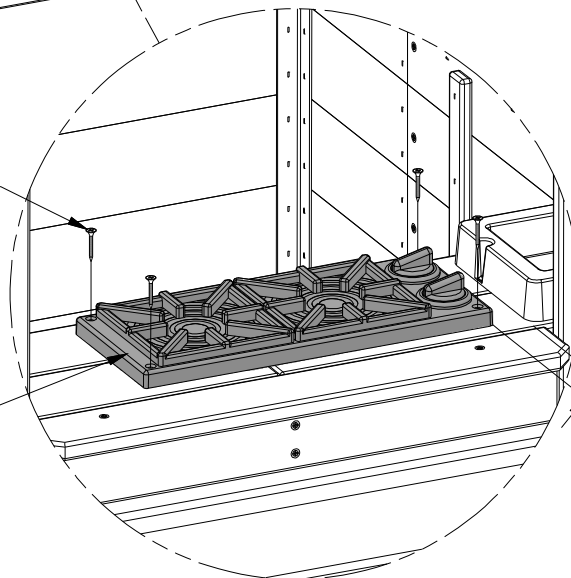

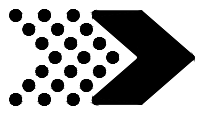

STEP 22

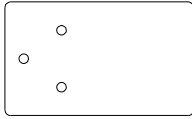

N3 | DOOR STOP - W4L17074
(x1) | 5/8"x2 3/8"x3 7/8" (16x60x100)



H100087 | SCREW PFH
(x3) | 8x1 1/4

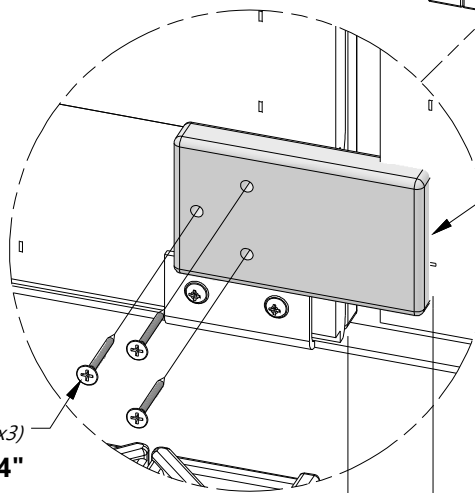
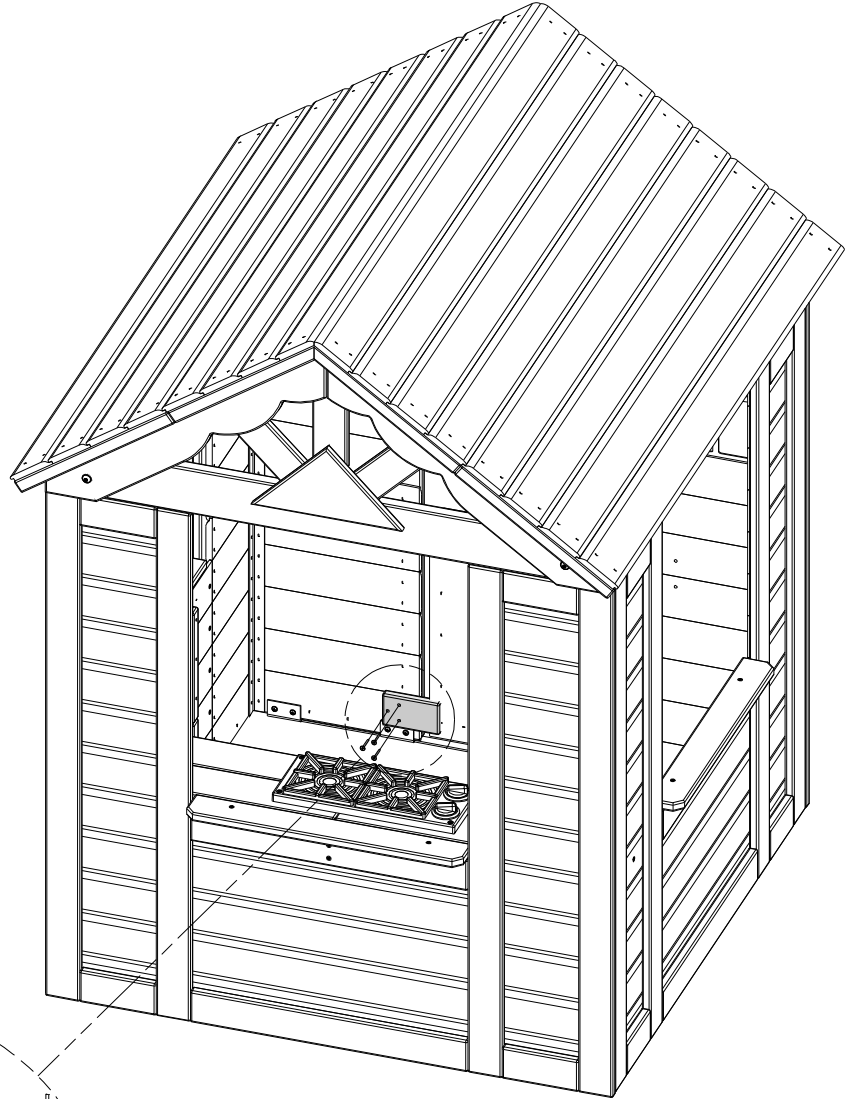

087 (x3)
SCREW - 1-1/4"

N3 (x1)
DOOR STOP

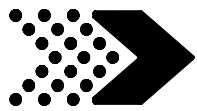

1 5/8 in
[40 mm]

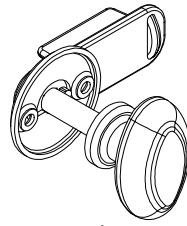

STEP 23

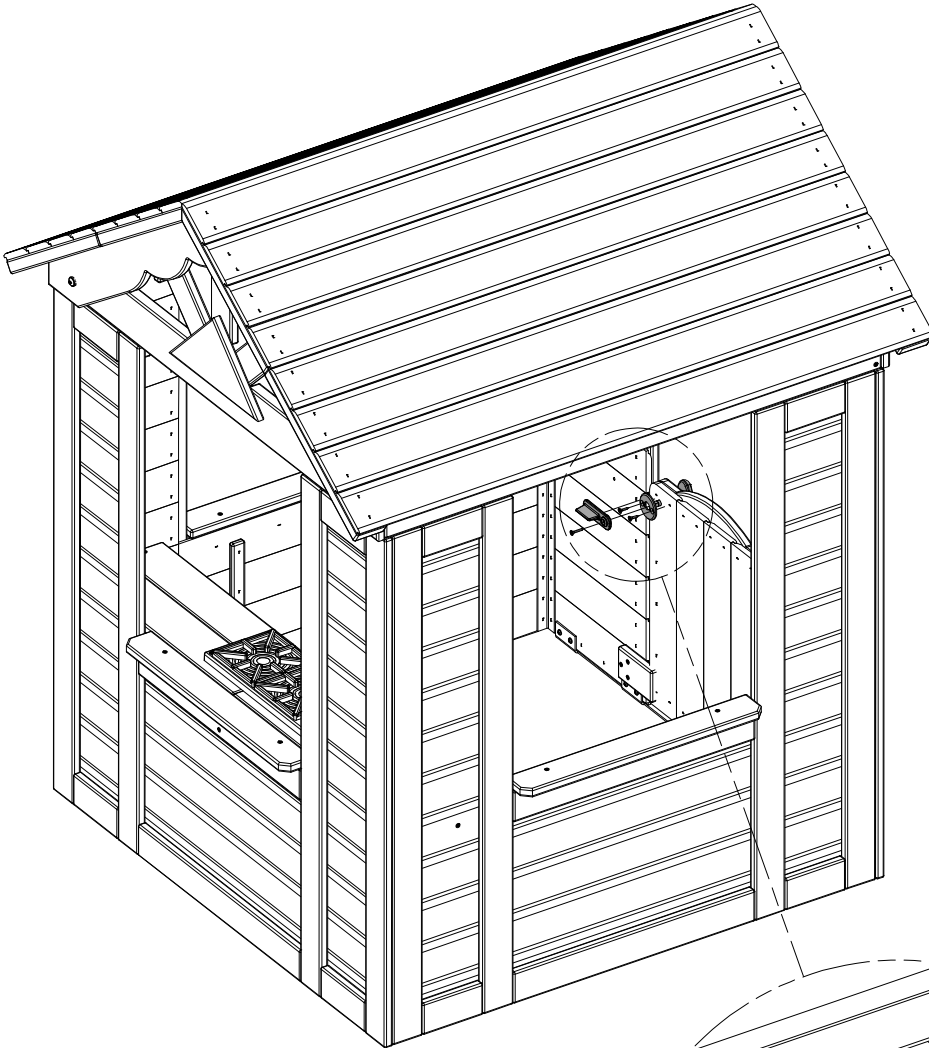

A6P00020
(x1) | **KNOB KIT**



TIP:
WHEN DOOR LATCH IS IN THE UNLOCKED POSITION IT SHOULD FACE IN THE UPWARD DIRECTION.



NOTE:
ALIGN FACE PLATE AS SHOWN BELOW THEN PRE-DRILL PILOT HOLES USING AN 1/8" [3 mm] DRILL BIT, 1/2" [12 mm] DEEP FOR HARDWARE.



NOTE ARCH IN FACE PLATE FACES UP.

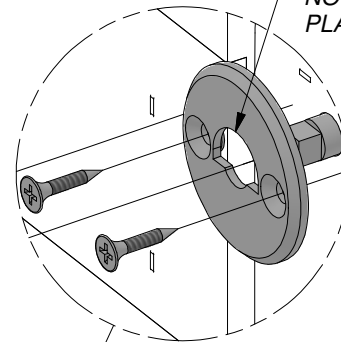

LATCH

SCREW - 1" (x1)
INCLUDED IN KNOB KIT

SCREW - 3/4" (x2)
INCLUDED IN KNOB KIT

020 (x1)
LATCHING KNOB KIT

KNOB

FACE PLATE

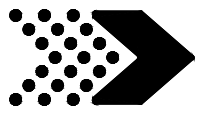

STEP 24

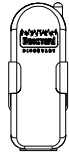

A100132 | PHONE KIT
(x1)



H100124 | SCREW PFH
(x2) 8 x 1/2

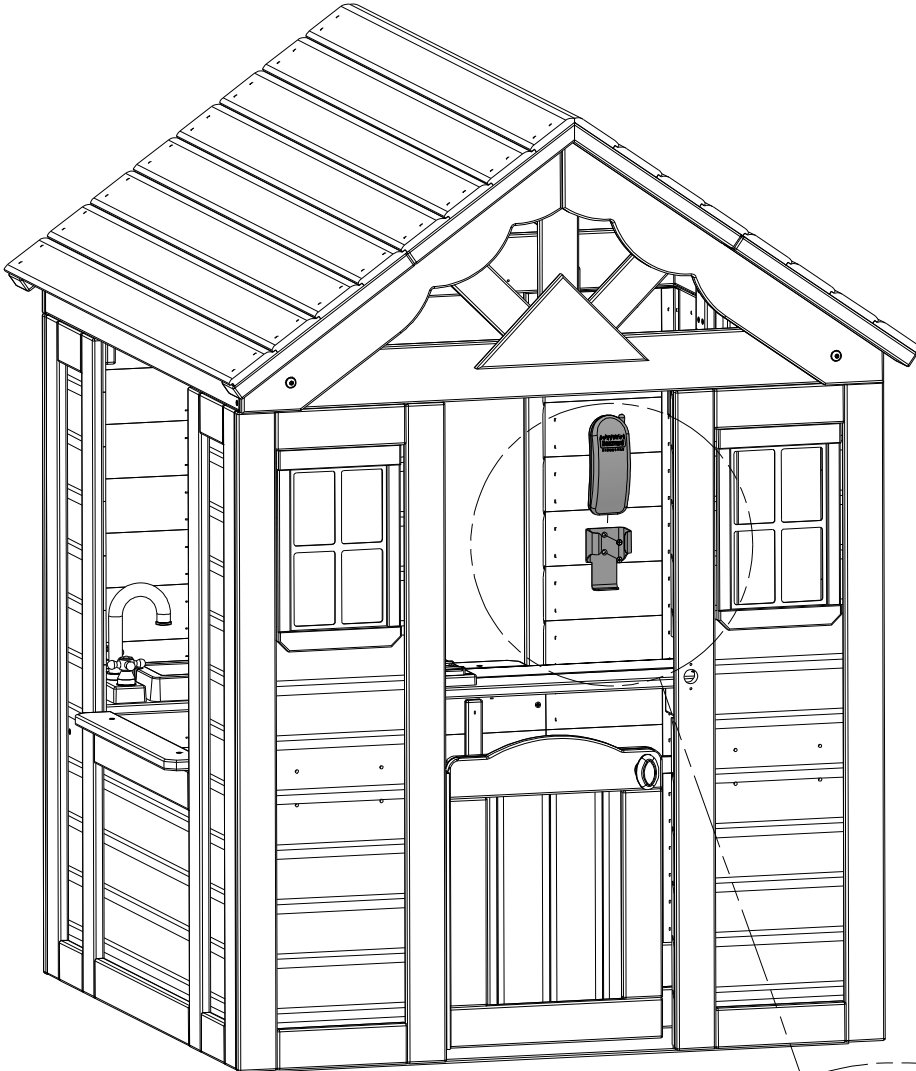

TIP:

CENTER PHONE AND MOUNT
USING THE DIMENSION BELOW
OR YOUR DESIRED LOCATION.

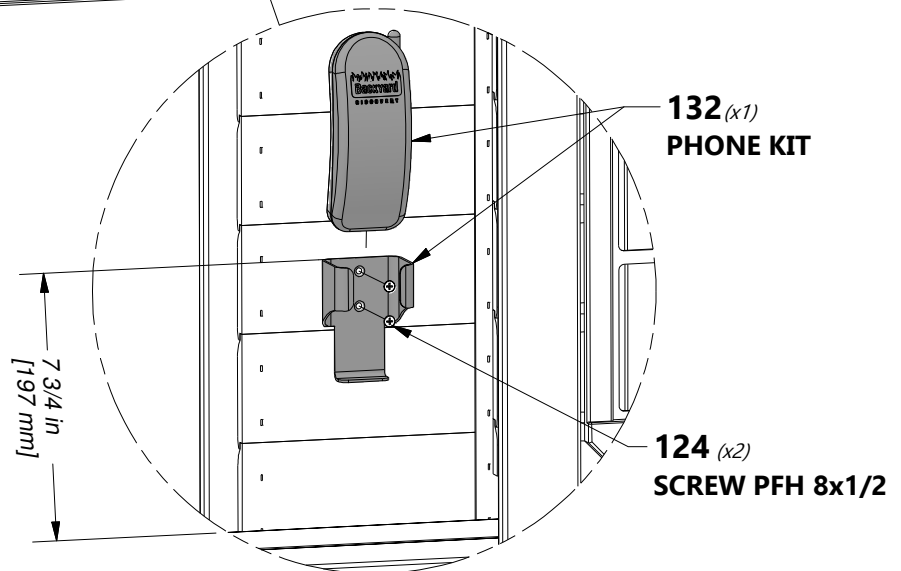

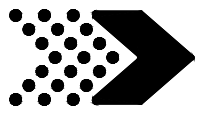

STEP 25

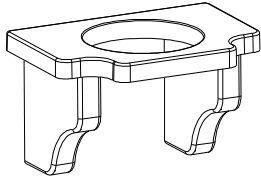

A6P00387
(x2) | **FLOWER POT HOLDER - BLK**



H100085 | **SCREW PFH**
(x8) | **8x1**

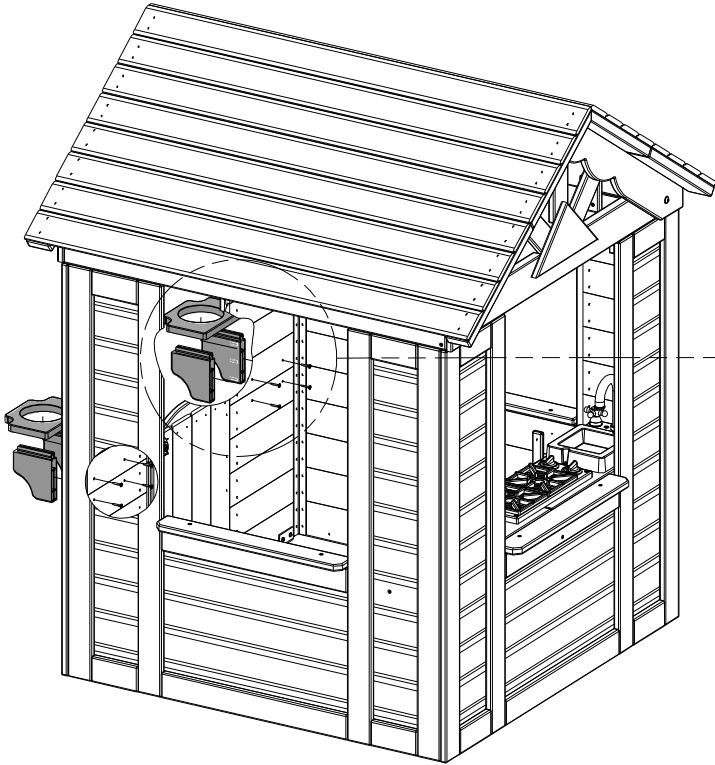

REPEAT ON OPPOSITE SIDE

387 (x1)
FLOWER POT HOLDER - BLK

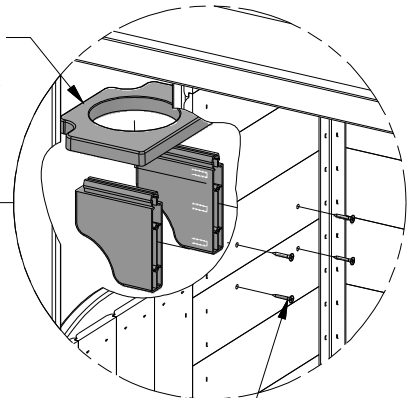

085 (x4)
SCREW - 1"

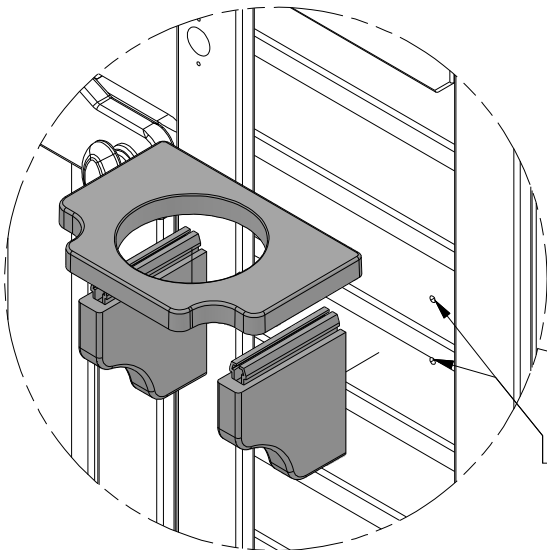

 **NOTE HOLE LOCATIONS**

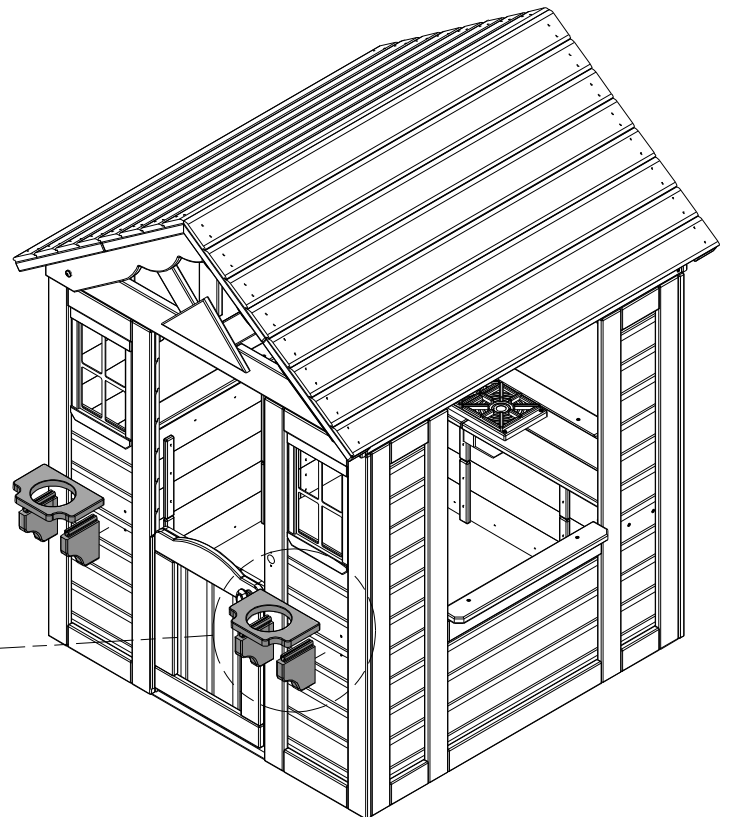

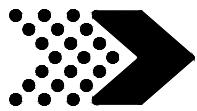

STEP 26



A4M00528 | BYD ID TAG (MEDIUM) AGES 2 TO 10
(x1)



H100361 | SCREW PWH
(x2) | 8x7/16

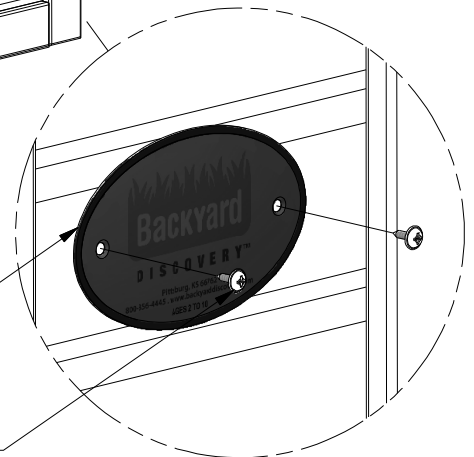
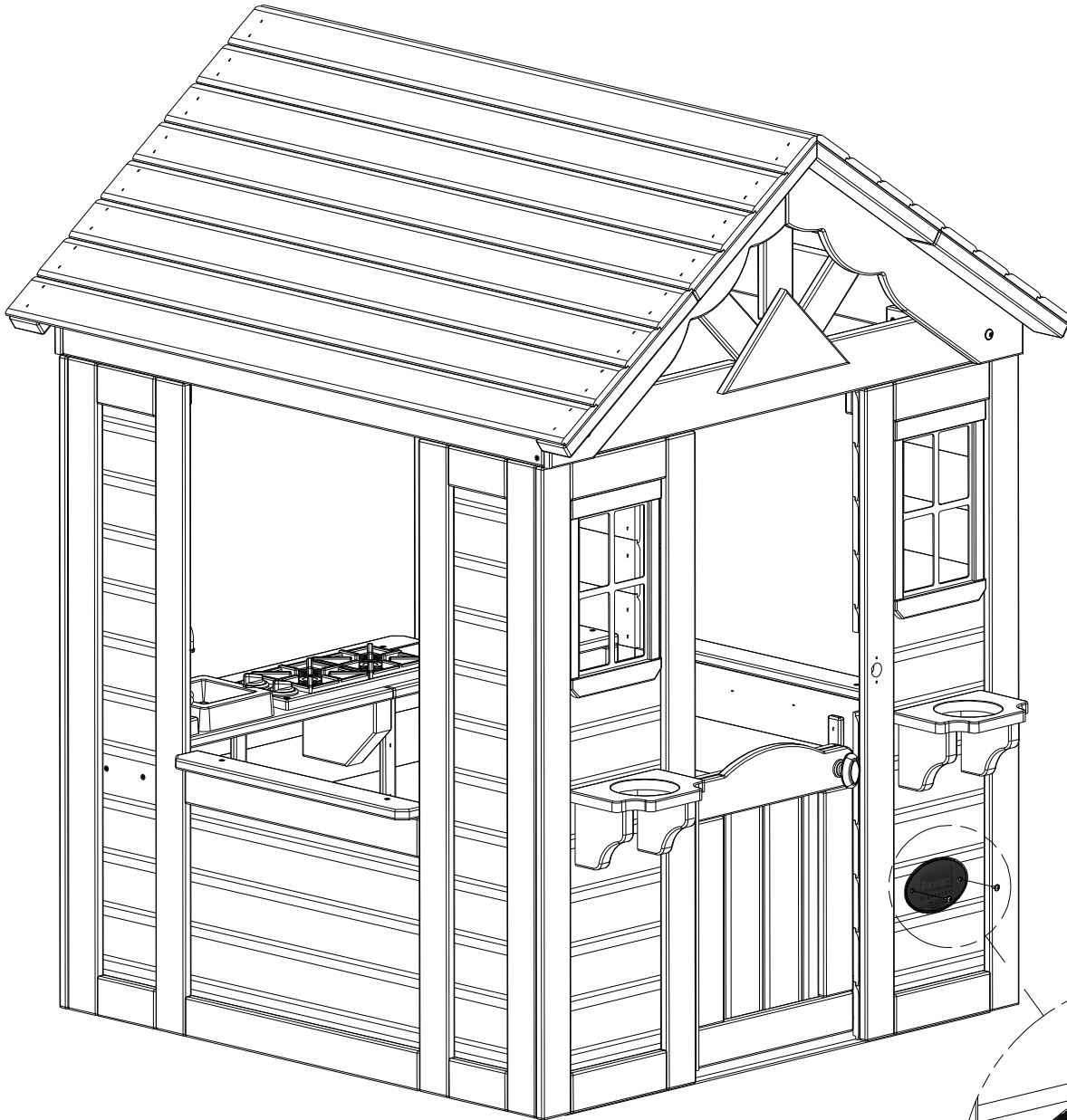

528 (x1)

BYD ID TAG (MEDIUM) AGES 2 TO 10

361 (x2)

SCREW - 7/16"

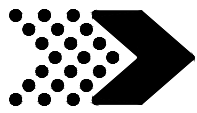

STEP 27

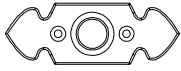

A6P00290 | DOOR BELL PLATE
(x1)

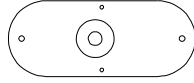

A100174 | DOOR BELL
(x1)



H100537 | SCREW PFH SD
(x2) | **8x1**



H100624 | SCREW PFH BLK
(x2) | **6x5/8**

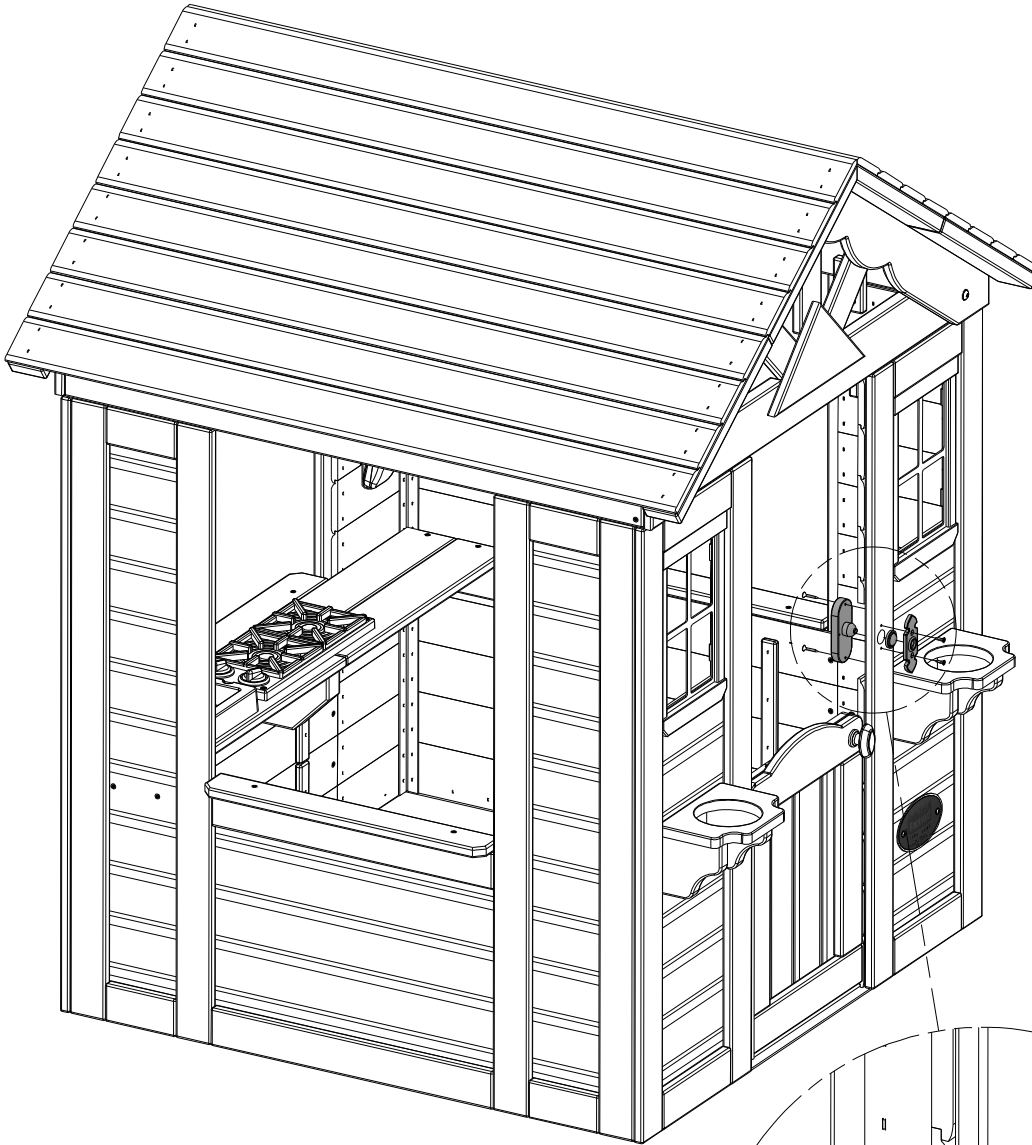

174 *(x1)*
DOOR BELL

537 *(x2)*
SCREW - 1"

 NOTE PILOT HOLES.

290 *(x1)*
DOOR BELL PLATE &
RUBBER BUTTON

624 *(x2)*
SCREW - 5/8"

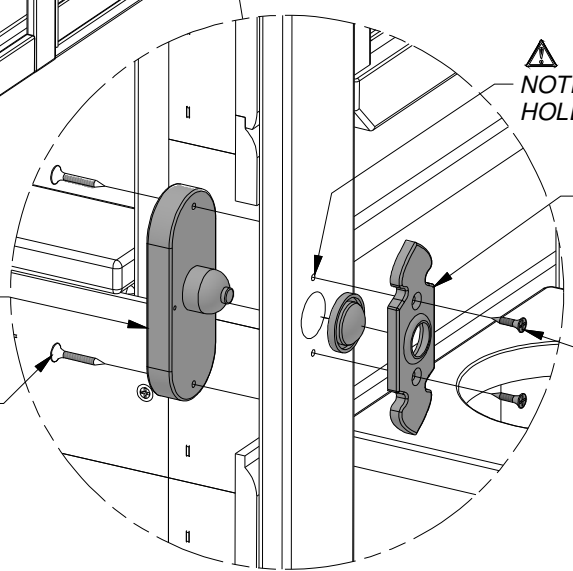



STEP 28

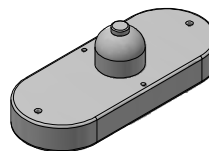

A100174
(x1) | **DOOR BELL**

NOTE:

- DO NOT MIX OLD AND NEW BATTERIES.
- DO NOT MIX ALKALINE, STANDARD (CARBON-ZINC), OR RECHARGEABLE (NI-CAD, NI-MH, ETC.) BATTERIES.
- NON-RECHARGEABLE BATTERIES ARE NOT TO BE RECHARGED.
- ONLY BATTERIES OF THE SAME OR EQUIVALENT TYPE AS RECOMMENDED ARE TO BE USED.
- BATTERIES ARE TO BE INSERTED WITH THE CORRECT POLARITY.
- EXHAUSTED BATTERIES ARE TO BE REMOVED FROM THE TOY OR IF THE TOY IS TO BE LEFT UNUSED FOR A LONG TIME.
- THE SUPPLY TERMINALS ARE NOT TO BE SHORT-CIRCUITED.

FCC LABEL

NOTE:

THIS DEVICE COMPLIES WITH PART 15 OF THE FCC RULES. OPERATION IS SUBJECT TO THE FOLLOWING TWO CONDITIONS: (1) THIS DEVICE MAY NOT CAUSE HARMFUL INTERFERENCE, (2) THIS DEVICE MUST ACCEPT ANY INTERFERENCE RECEIVED, INCLUDING INTERFERENCE THAT MAY CAUSE UNDESIRABLE OPERATION.

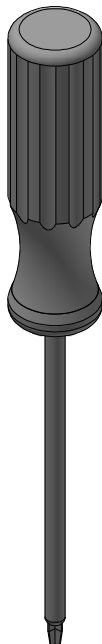

NOTE:

USING A SCREW DRIVER, REPLACE BATTERIES BY REMOVING SCREW IN BATTERY COVER, REMOVING BATTERY COVER AND FOLLOWING DIRECTIONS FOR BATTERY REPLACEMENT LOCATED ON THE BATTERY COVER.

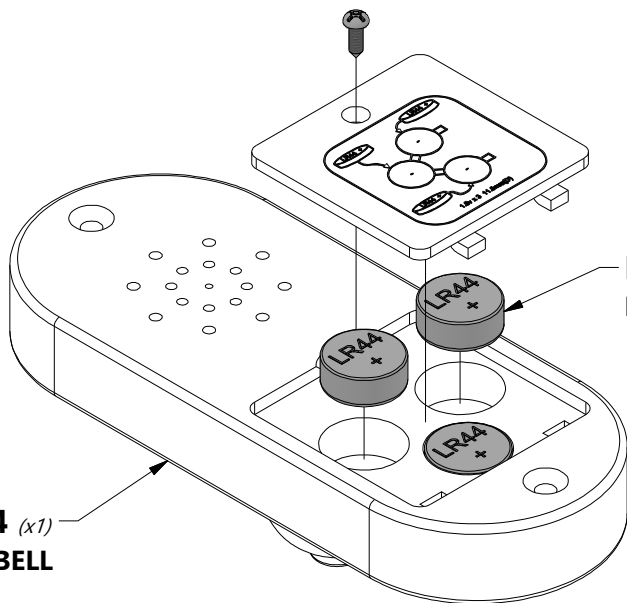

LR44 (x3)
BATTERY (INCLUDED)

174 (x1)
DOOR BELL



WARNING:

1. KEEP BATTERIES OUT OF THE REACH OF CHILDREN.
2. SWALLOWING MAY LEAD TO SERIOUS INJURY OR DEATH IN AS LITTLE AS 2 HOURS, DUE TO CHEMICAL BURNS AND POTENTIAL PERFORATION OF THE ESOPHAGUS.
3. IF YOU SUSPECT YOUR CHILD HAS SWALLOWED A BUTTON BATTERY, IMMEDIATELY SEEK URGENT MEDICAL ASSISTANCE.
4. EXAMINE DEVICES AND MAKE SURE THE BATTERY COMPARTMENT IS CORRECTLY SECURED, E.G. THAT THE SCREW OR OTHER MECHANICAL FASTENER IS TIGHTENED. DO NOT USE IF COMPARTMENT IS NOT SECURE.
5. DISPOSE OF USED BUTTON BATTERIES IMMEDIATELY AND SAFELY. FLAT BATTERIES CAN STILL BE DANGEROUS.
6. TELL OTHER OF THE RISK ASSOCIATED WITH BUTTON BATTERIES AND HOW TO KEEP THEIR CHILDREN SAFE.