

ULTRAMITE

Handheld UV Dust Mite Allergen Vacuum

Owner's Manual

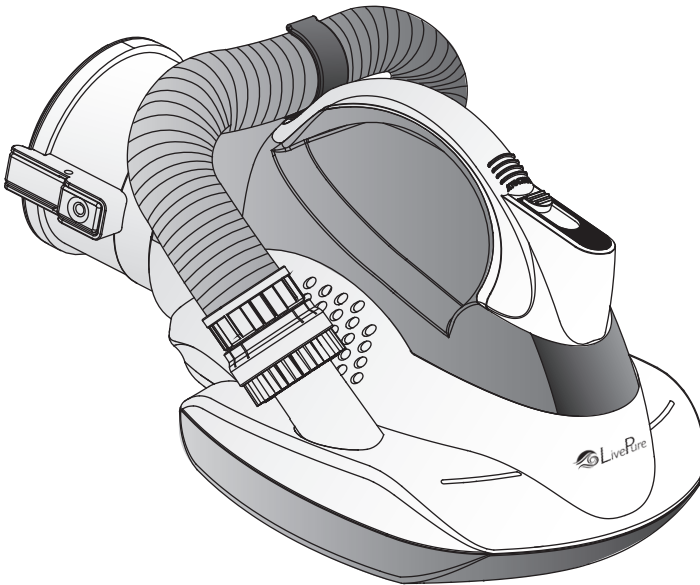

Model
LP5000DMVC

Form # LP5000DMVC-1
20180321
© 2018 ® Registered Trademark/TM Trade mark of LivePure LLC
Manufactured for LivePure LLC
All rights reserved





Getting to Know Your Vacuum

Introduction and Product Specifications..... 3
Parts and Accessories 4

Important Safety Instructions

Caution, Warning, and Instructions 5

Operation

Controls and Display 6
Cleaning Modes 7

Maintenance

Cleaning the Dust Basket 8
Filter and UV Care.....9

Troubleshooting

Common Issues and Solutions 10

Warranty

Warranty11



WARNING:
Cancer and Reproductive Harm -
www.P65Warnings.ca.gov.



Welcome!

Thank you for purchasing the LivePure™ Ultramite™ Handheld UV Dustmite Vacuum. Please read the instruction manual prior to use and follow all directions to ensure best results

Features:

- Powerful 650 Watt motor
- Cyclone technology dust collection basket - rotational movement rolls vacuumed objects and divides large from small
- HEPA filter - this vacuum contains a HEPA filter to remove particles as small as 0.3 microns, capturing the particles on the filter
- UV lamp - 253.7 nm UV wavelength bulb helps to reduce bacteria, viruses, dust mites, and eggs from the exposed surfaces
- Range Sensor - This sensor ensures that the UV lamp is activated only when within 1.2 inches (3cm) of the surface to be cleaned
- Rolling Brush System - Vacuum uses a rolling brush to remove deeply engrained dust and debris, as well as aid in removing human and pet hair.
- Fabric Protection Grill - Covers the rolling brush to keep fabric from getting caught in the brush
- Transparent Large Capacity Dust Basket - Collects up to 34.8 in³ (570 cc) and the transparent design lets you know when to empty and clean the dust basket
- Extendable Vacuum Hose - Vacuum comes with a hose mode to clean hard to reach areas. Hose can be used with or without the extendable brush for versatile cleaning
- 45° angle air discharge - air is vented out through the side of the vacuum at a 45° angle, keeping vented air away from user and from surface being cleaned

Product Specifications:

Product Name	LivePure™ Ultramite™	Disinfection	UV Lamp
Size	8.75" x 14.1" x 7.9"	Filter	HEPA Filter
Weight	6.4 lbs.	UV Control	Sensor
Color	White and black	Special Function	Vacuum Hose
Motor	Main Motor: 600W Sub Motor: 45W	Power Power Consumption	120V, 60Hz 650W
Dust Basket Capacity	570cc / 34.8 in ³	Power Cable	Length: 16.4 ft. / 5 m
Vacuum Type	Cyclone & Rolling Brush	Button Type	Slide Button

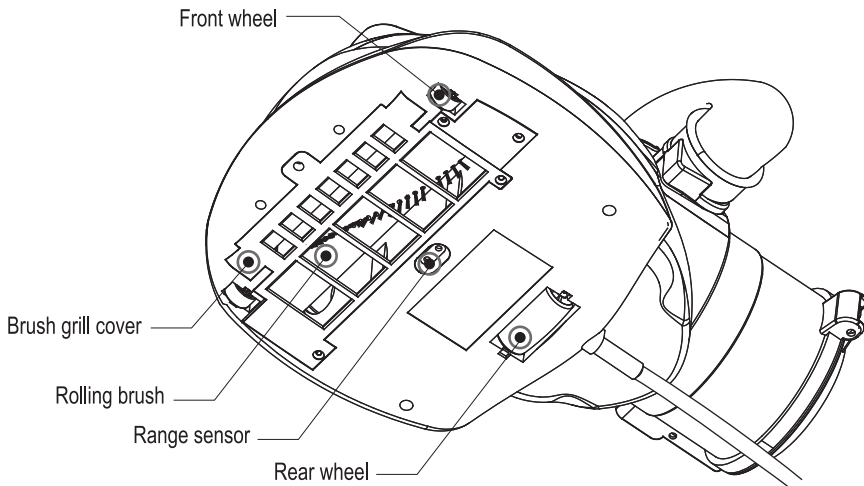
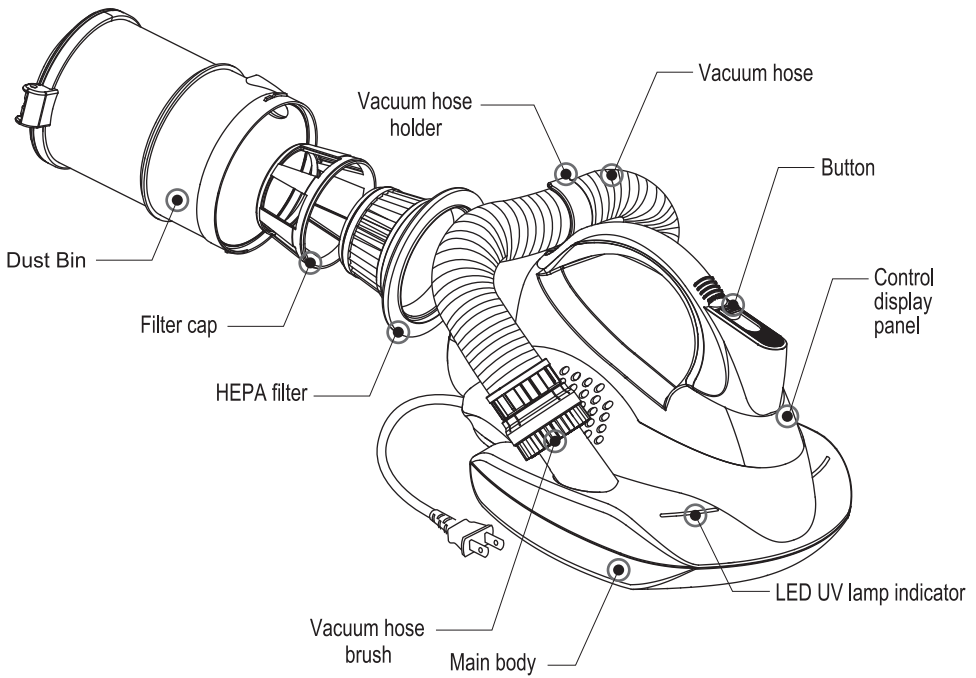

Important Safety Instructions

SAVE THESE INSTRUCTIONS

IMPORTANT: READ THESE INSTRUCTIONS CAREFULLY BEFORE ASSEMBLY AND USE. THIS PRODUCT IS INTENDED FOR HOUSEHOLD USE ONLY. IF USED COMMERCIALY, WARRANTY IS VOID. THIS PRODUCT IS INTENDED ONLY FOR USE IN THE UNITED STATES AND CANADA. USE OUTSIDE OF THE UNITED STATES OR CANADA WILL VOID THE WARRANTY.



WARNING: TO REDUCE THE RISK OF FIRE, ELECTRIC SHOCK, DAMAGE, OR INJURY:

- Fully assemble before operating.
- Operate vacuum only at voltage specified on data label on bottom of machine
- Do not leave appliance when plugged in. Unplug from outlet when not in use and before cleaning or servicing.
- Do not use outdoors or on wet surfaces.
- Not intended for use by children under age 12. Do not allow to be used as a toy. Close attention is necessary when used near children. To avoid injury or damage, keep children away from product, and do not allow children to place fingers or other objects into any openings.
- Use only as described in this manual.
- Do not use with a damaged plug or cord. If appliance is not working as it should, has been dropped, left outdoors, or dropped into water, discontinue use and call for service.
- Do not carry or pull by cord, use cord as a handle, close a door on a cord, or pull cord around sharp edges or corners. Do not place product on cord. Do not run appliance over cord. Keep cord away from heated surfaces.
- Do not unplug by pulling cord. Instead, grasp the plug firmly and pull to unplug.
- Do not handle plug or appliance with wet hands.
- Do not put any object into openings. Do not use with any opening blocked. Keep free of dust, lint, hair, and anything that may reduce air flow.
- Keep hair, loose clothing, fingers, and all parts of body away from openings and moving parts.
- Turn off all controls before unplugging.
- Do not use to pick up flammable or combustible liquids, such as gasoline or fine wood shavings, or use in areas where they may be present.
- Do not use to pick up metal pieces such as pins or screws, or any other pieces of metal.
- Do not use to pick up anything that is burning or smoking, such as cigarettes, matches, or hot ashes.
- Do not use without dirt cup and filter in place.
- Do not expose eyes or other body parts directly to UV light as UV light can be harmful to skin. UV light should not be used on plants or animals as it can cause harm.
- This product is not intended for extended vacuum use on tile, wood, or other hard flooring surfaces.
- This product is not for use with any detergents or cleaning solutions.
- When cleaning the HEPA filter, wash with water. Do not use detergent to clean filter.
- Do not use when dust bin is full.
- Do not use with a wet HEPA filter. Ensure HEPA filter is completely dry before installing and using product after cleaning.
- Do not use sharp objects to clean out the hose as they may cause damage.
- With brush roller on, do not allow cleaner to sit in one location for an extended period of time, as damage to machine or surface can result.

WARNING: TO REDUCE THE RISK OF ELECTRIC SHOCK, THIS APPLIANCE HAS A POLARIZED PLUG (ONE BLADE IS WIDER THAN THE OTHER). THIS PLUG WILL FIT IN A POLARIZED OUTLET ONLY ONE WAY. IF THE PLUG DOES NOT FIT FULLY IN THE OUTLET, REVERSE THE PLUG. IF IT STILL DOES NOT FIT, CONTACT A QUALIFIED ELECTRICIAN TO INSTALL THE PROPER OUTLET. DO NOT CHANGE THE PLUG IN ANY WAY.

Safety Warning - Please read and follow all instructions for use of this vacuum cleaner. Pay attention to these alert symbols:



Warning - you could damage property or cause injury if you do not immediately follow these instructions



Caution-You could cause the vacuum to be damaged if you do not follow these instructions

User Controls

3 Cleaning Modes:

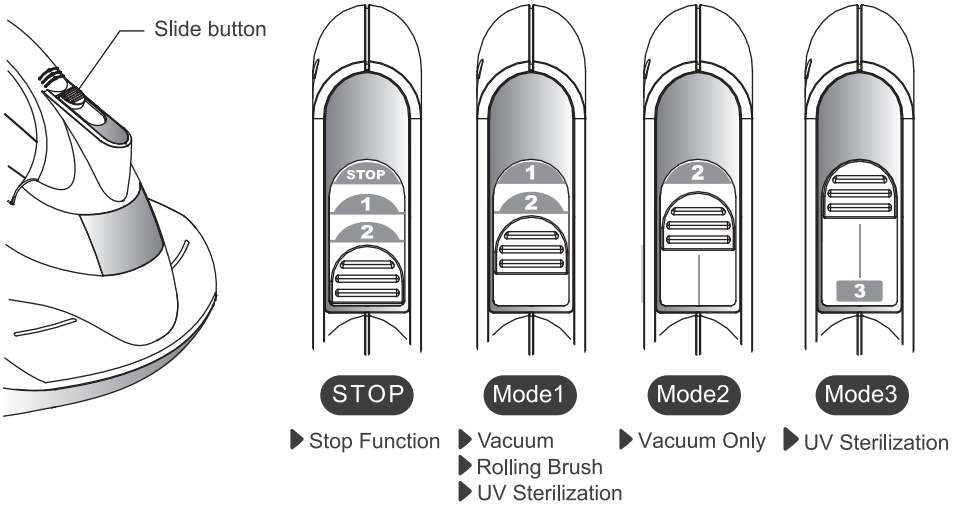

Display

Lights and Indicators:

Control Display Panel

Vacuum UV Hose

Note: Hose indicates Vacuum only.

Mode function Indication		
Vacuum	UV Sterilization	Vacuum
Vacuum & Rolling brush are working	UV lamp is working	Vacuum hose is working
Display Color : Green	Display Color : Blue	Display Color : Green

UV lamp indicator

Note Green UV lamp indicators are lit when UV is in use. Indicators are LED and not harmful.

Mode 1 : Vacuum & UV Sterilization

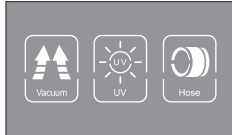
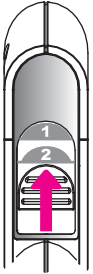

Slide the button from 'STOP' to 'Mode 1'.
You can use all functions.

▶ Vacuum + Brush Rolling + UV Sterilization

Note: Vacuum Hose must be installed to the pipe of main body on Mode1.

Mode 2 : Vacuum hose

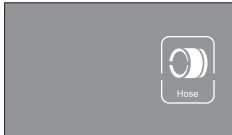
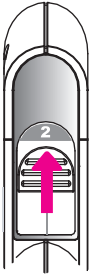

Slide the button to 'Mode 2'.
Remove hose from pipe on main body of vacuum.

▶ Vacuum hose is working

Note: Pull hose brush out during use of hose. Push brush in to reattach to body of vacuum.

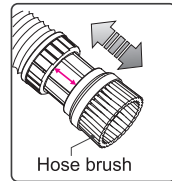
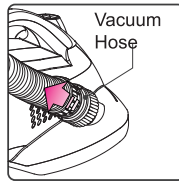

Mode 3 : UV Sterilization

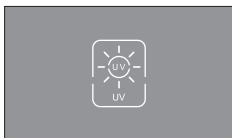
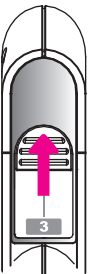

Slide the button to 'Mode 3'.
You can Sterilize.

▶ UV Sterilization

Note: Bottom surface of vacuum cleaner must be within 1.2" (3cm) of surface to activate UV light.

Remove and Replace Dust Basket:

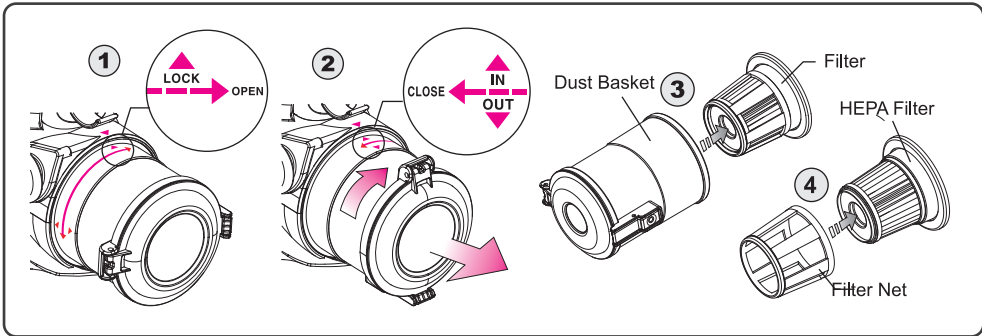

Step 1:

Check "LOCK" arrow matches with arrow on main body. Dust basket is installed correctly.

Step 2:

Turn dust basket clockwise to remove from main body.

Step 3:

HEPA filter is attached to basket by the rubber ring. Pull HEPA filter firmly to remove.

Step 4:

Remove filter net from HEPA filter.

Clean Dust Basket:

Step 1:

Empty dust from dust basket.

Step 2:

Submerge dust basket in water. Clean with mild detergent.

Step 3:

Allow to dry thoroughly before reinstalling in vacuum.

⚠ Caution

To minimize dust exposure, empty basket into trash bag while keeping bag closed as much as possible. Dispose of bag immediately.

⚠ Caution

Do not put damp or wet filters back in vacuum as this can damage vacuum.

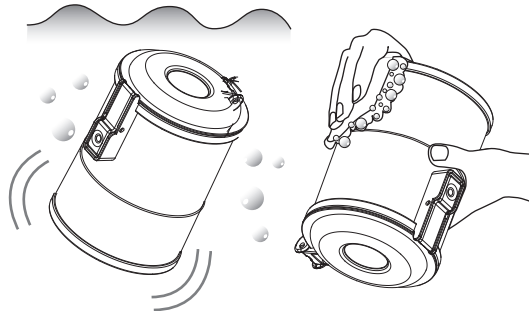

in the water

with detergent

Cleaning the HEPA Filter:

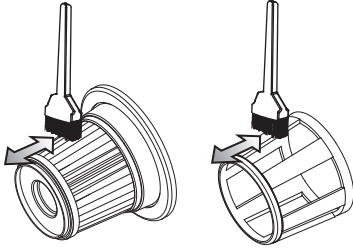

Clean with Brush

After shaking dust off the HEPA filter and filter net, use brush to clean.

Note

Filters can be replaced if needed in cases where filter is too dirty or has an odor that normal cleaning cannot remove.

Changing the UV Lamp:

Step 1: Make sure unit is unplugged.

Step 2: Remove screw and brush grill cover.

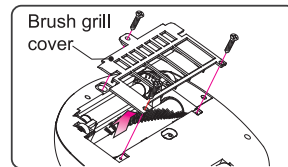

Step 3: Place thumbs on ends of bulb, roll bulb toward rear of unit until prongs are visible. Remove lamp, replace with new bulb, roll back into locked position.

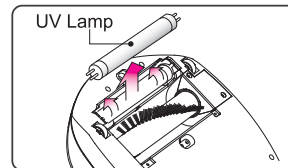

Cleaning Rolling Brush:

Clean rolling brush with vacuum hose. You may remove grill cover for more effective cleaning.

Cleaning Vacuum Hose:

Step 1: Turn hose clockwise to remove from body.

Step 2: Turn hose clockwise to remove brush from end of hose.

Step 3: Clean hose and brush with water. Let dry completely before reassembling.

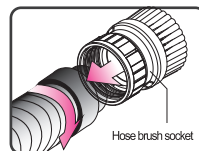
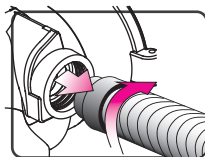

Problem: No power, no display.

Solution:

1. Check that vacuum is plugged in.
2. Check power to outlet.
3. Check circuit breaker for tripped circuit.
4. Call for service.

Problem: Vacuum emits odor.

Solution:

1. New unit may have an odor from manufacturing process. This is normal and odor should be gone after 5-10 uses.
2. HEPA filter may be dirty. Clean HEPA filter.

Problem: Green UV lamp indicator doesn't light.

Solution:

1. Check cleaning mode. If in mode 2 or off, UV light will not activate.
2. UV light may be expired. Change UV light.
3. Check UV lamp installation for proper placement.
4. Check distance between UV lamp sensor and surface to clean. UV lamp will not activate if more than 1.2 inches from object.

Problem: Rolling brush does not work.

Solution:

1. Check cleaning mode. Brush roller operates only in cleaning mode 1.
2. Check roller for foreign objects. Remove debris and foreign objects from roller brush area.

Problem: Weak or no suction.

Solution:

1. Check cleaning mode. Vacuum must be in mode 1 or 2 for vacuum function.
2. Check to ensure hose is properly attached. Reattach if needed.
3. Check hose for debris. Remove hose and unclog if needed.
4. Check filter for debris. If HEPA filter is clogged clean filter and net.
5. Check dust basket installation and adjust if needed.

Problem: Unit shuts off after extended use.

Solution:

1. Check and clean HEPA filter if clogged.
2. Temperature sensor detects motor is too warm. Allow vacuum to rest for 2 hours, then you can resume use.



Warranty

2 Year Limited Guarantee

The LivePure company, Inc. makes the following warranty to the original residential user or consumer purchaser of the Ultramite™ Allergen Vacuum:

If any part of The Ultramite™ Allergen Vacuum fails during the first 1 (one) year from the date of purchase due to a defect in material or workmanship, we will provide a replacement part free of charge.

If no replacement part can be provided, we will replace your vacuum.

If the vacuum motor fails within the first 2 (two) years from the date of purchase due to a defect in workmanship or material, we will replace, or, at our option, repair the unit free of charge at our nearest service center. You will be responsible for all parts and labor costs after this period.

IF THE ORIGINAL RESIDENTIAL USER OR CONSUMER PURCHASER CEASES TO OWN THE ULTRAMITE™ ALLERGEN VACUUM, THIS WARRANTY AND ANY IMPLIED WARRANTY WHICH THEN REMAINS IN EFFECT, INCLUDING BUT NOT LIMITED TO ANY IMPLIED WARRANTY OF MERCHANTABILITY OR FITNESS FOR A PARTICULAR PURPOSE, ARE VOIDED. THIS WARRANTY IS IN LIEU OF ALL OTHER EXPRESS WARRANTIES. THE DURATION OF ANY IMPLIED WARRANTY, INCLUDING BUT NOT LIMITED TO ANY IMPLIED WARRANTY OF MERCHANTABILITY OR FITNESS FOR A PARTICULAR PURPOSE IS EXPRESSLY LIMITED TO THE PERIOD OF THE EXPRESS WARRANTY SET FORTH ABOVE.

This warranty is voided if your Ultramite™ Allergen Vacuum is not purchased and used in the USA or Canada.

This warranty excludes and does not cover defects, malfunctions, or failures of the vacuum which were caused by repairs by persons not authorized by us, use of parts, or accessories not authorized by us, mishandling, modifications, or damage to the vacuum while in your possession, or unreasonable use, including failure to provide reasonable and necessary maintenance. This warranty does not cover vacuums used in commercial applications. There are no express or implied warranties as to commercial purchasers or users.

Technical Support: If you have any additional questions or problem with your LivePure Vacuum, please call the Customer Service Center toll-free: USA/Canada:888-855-5426. Hours of operation are from 8:00 am to 6:00 pm EST. You may also contact us over the Internet at: www.livepureshop.com.

Technical Support:

If you have any additional questions or problem with your LivePure Air Purifier, please call the Customer Service Center toll-free:

USA& Canada: 888-855-5426

HOURS OF OPERATION ARE MONDAY-FRIDAY
8:00AM-6:00PM EST, YOU MAY ALSO CONTACT US
OVER THE INTERNET AT www.livepureshop.com

Replacement Filters and Parts:

Replacement filters may be ordered by visiting our website at www.livepureshop.com . You may also call our Customer Service Center at 888-855-5426.

