

ASSEMBLY INSTRUCTION

LEFT/RIGHT REVERSIBLE SLEEPER CORNER SOFA

ASSEMBLY TIPS:







1. Take out hardware from box and sort by size.
2. Please check to see that all hardware and parts are present prior to start of assembly.
3. Please follow attached instruction in the same sequence as numbered to assure fast & easy assembly.

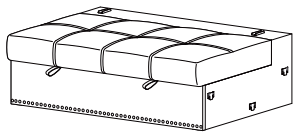
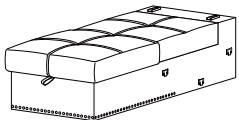
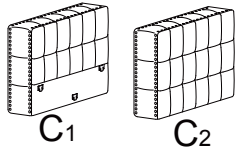
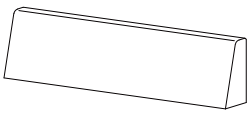
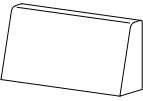
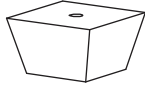
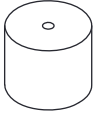
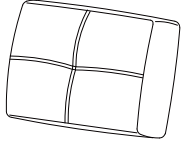

warning!

1. Don't attempt to repair or modify parts that are broken or defective. Please contact the store immediately.
2. This product is for home use only and not intended for commercial establishment.

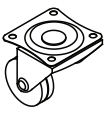
PARTS IDENTIFICATION

A	 SOFA FRAME	1pc	B	 CHAISE FRAME	1pc
C	 C1 C2 ARMREST	2pcs	D	 BACKREST (FOR SOFA)	1pc
E	 BACKREST (FOR CHAISE)	1pc	F	 LEGS	6pcs
G	 LEGS	6pcs	H	 BACK CUSHION	3pcs
I	 SCREWS	6pcs	J	 BOLTS	6pcs
K	 ALLEN KEY	1pc	L	 CASTER	2pcs
M	 SCREW 20mm (FOR PULL OUT BED)	8pcs			

STEP1:

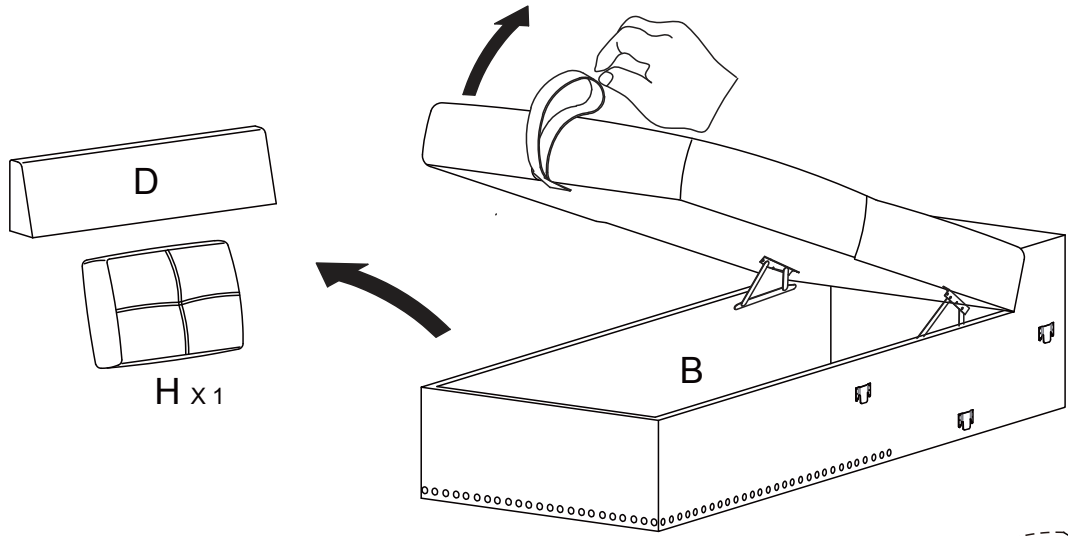

STEP2:

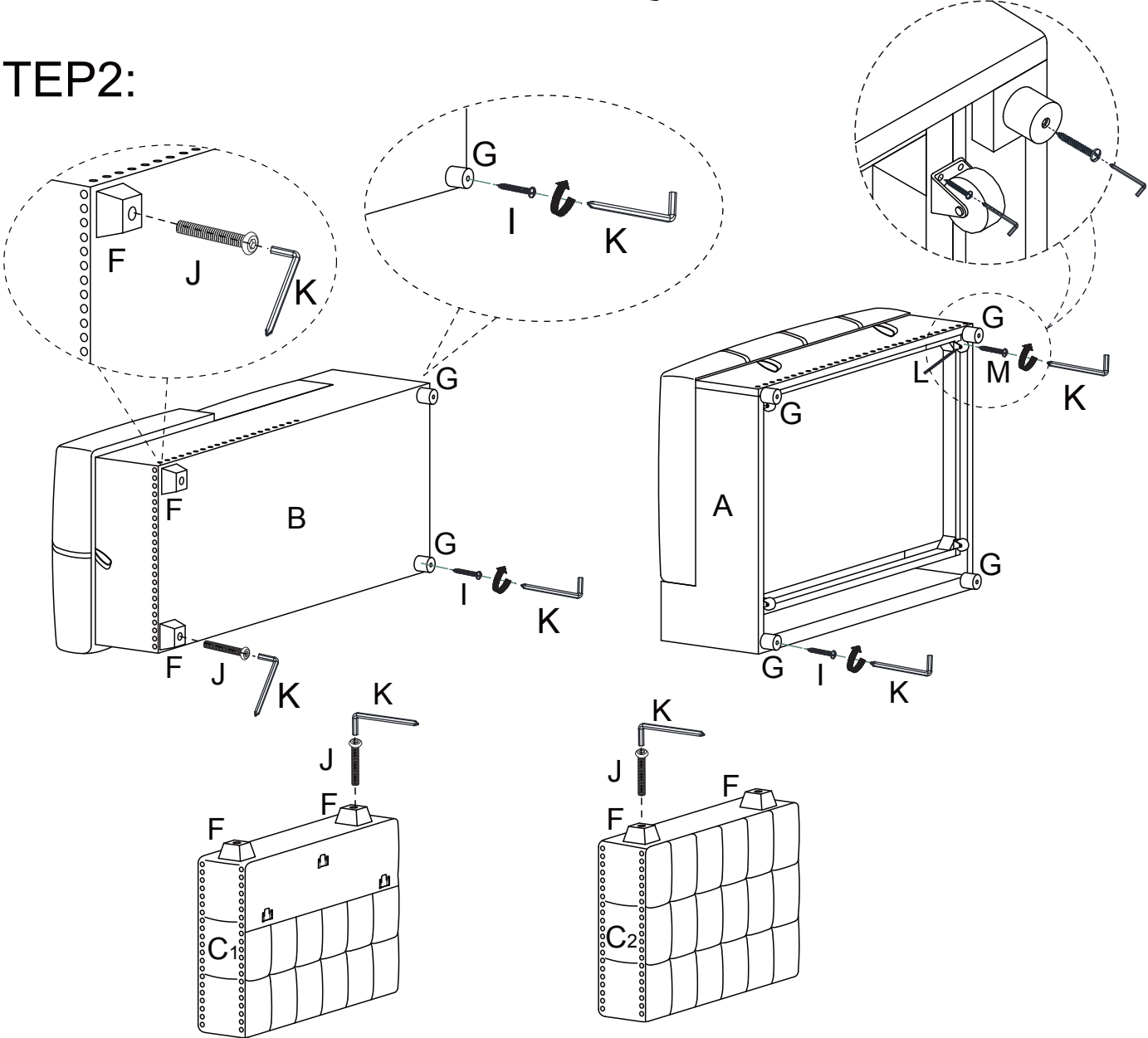

STEP3:

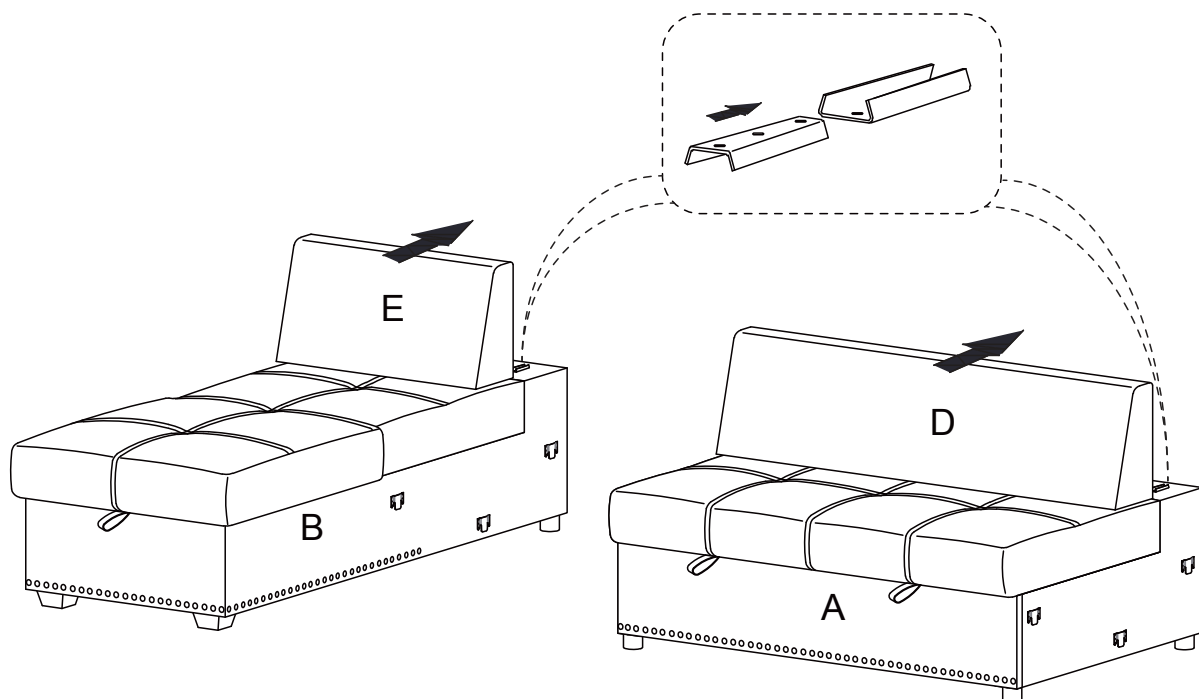

STEP4:

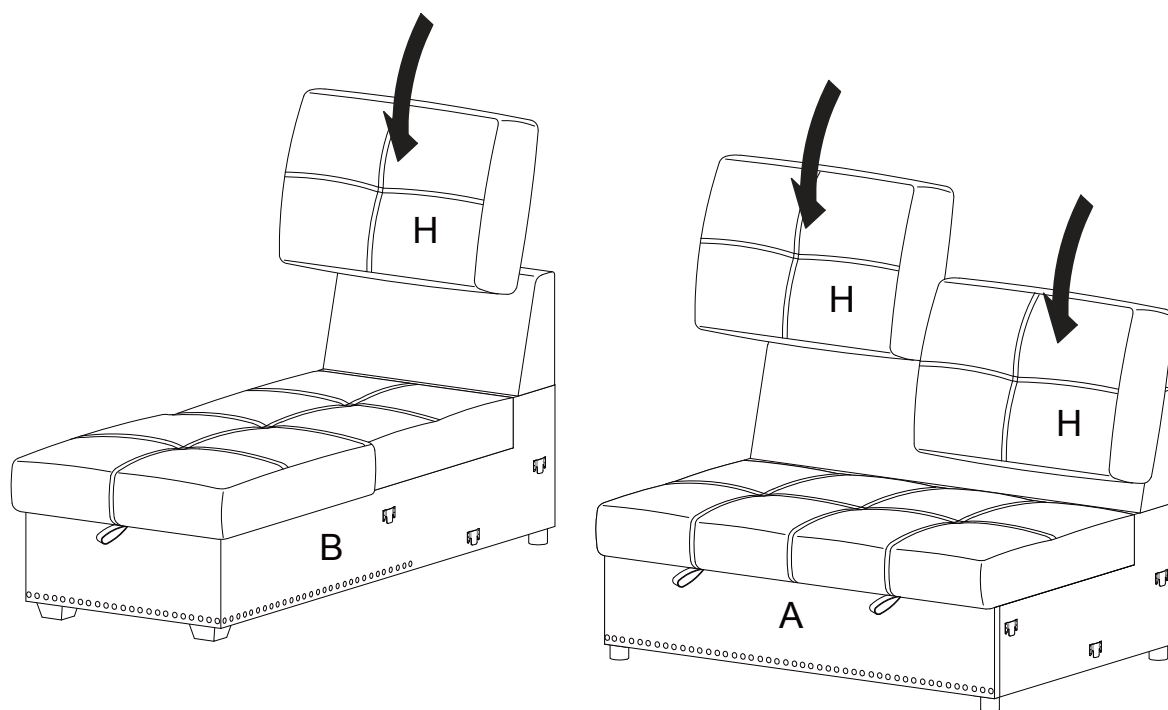

RIGHT SOFA & LEFT CHAISE

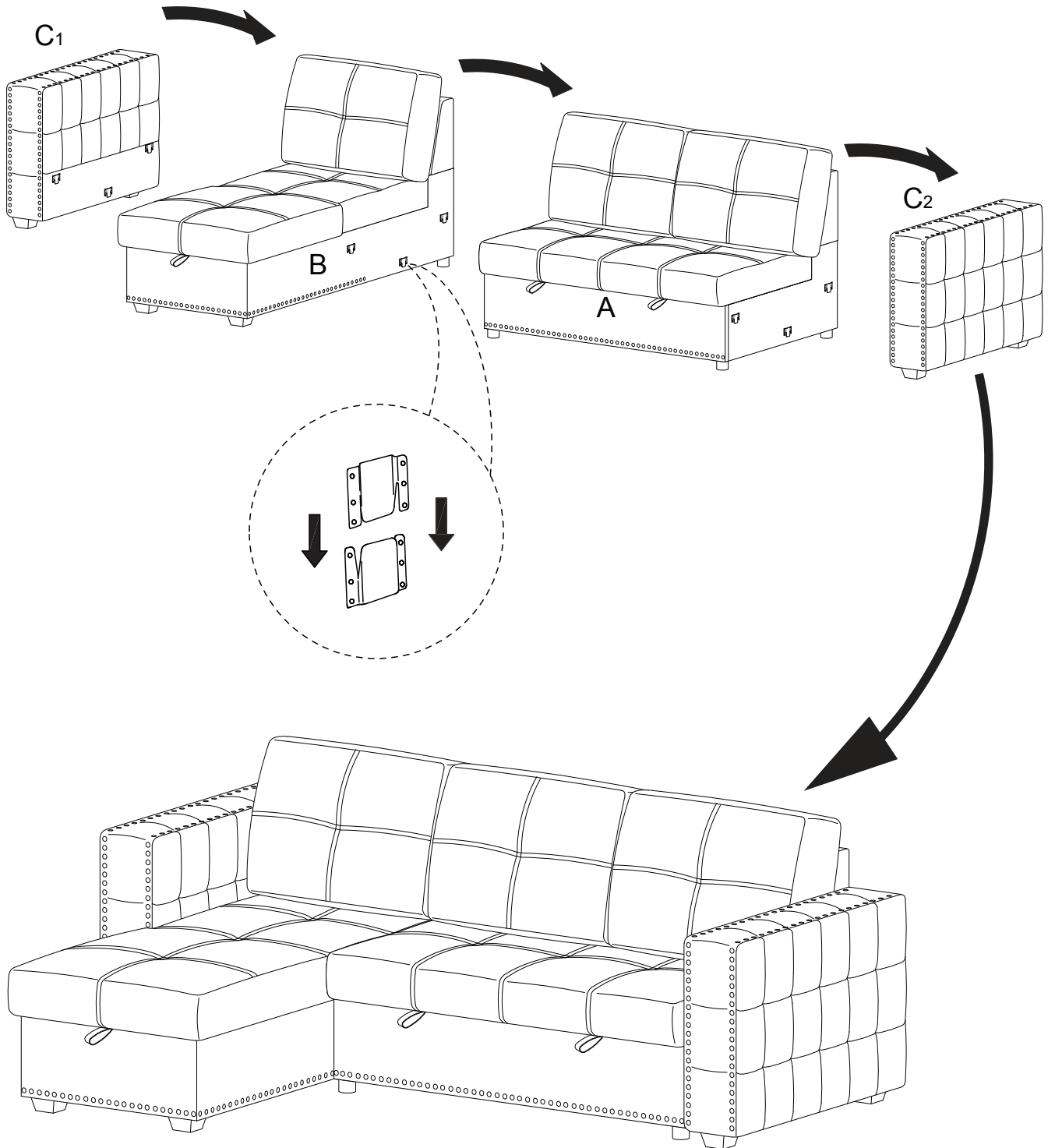

LEFT SOFA & RIGHT CHAISE

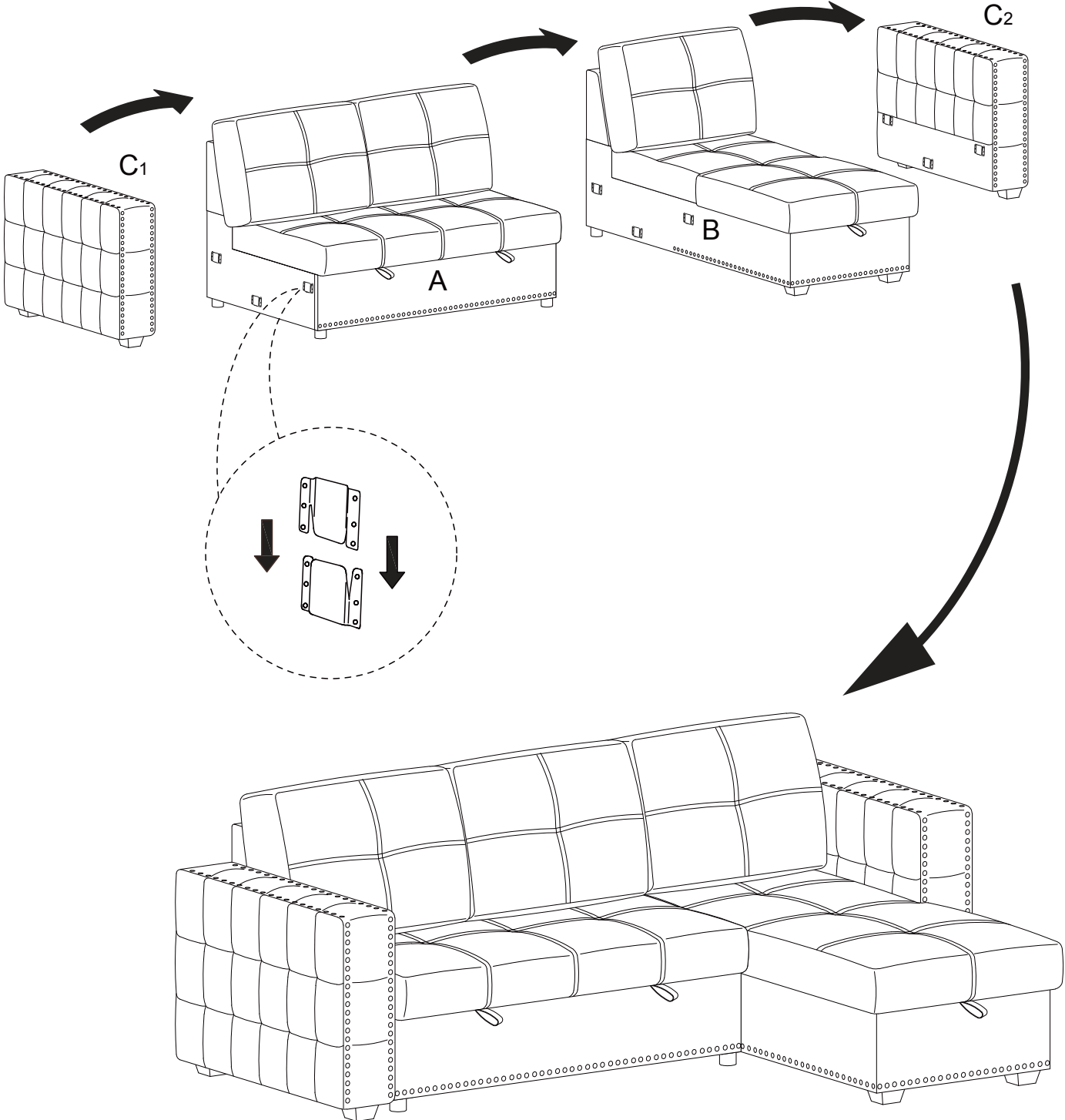

STEP5:

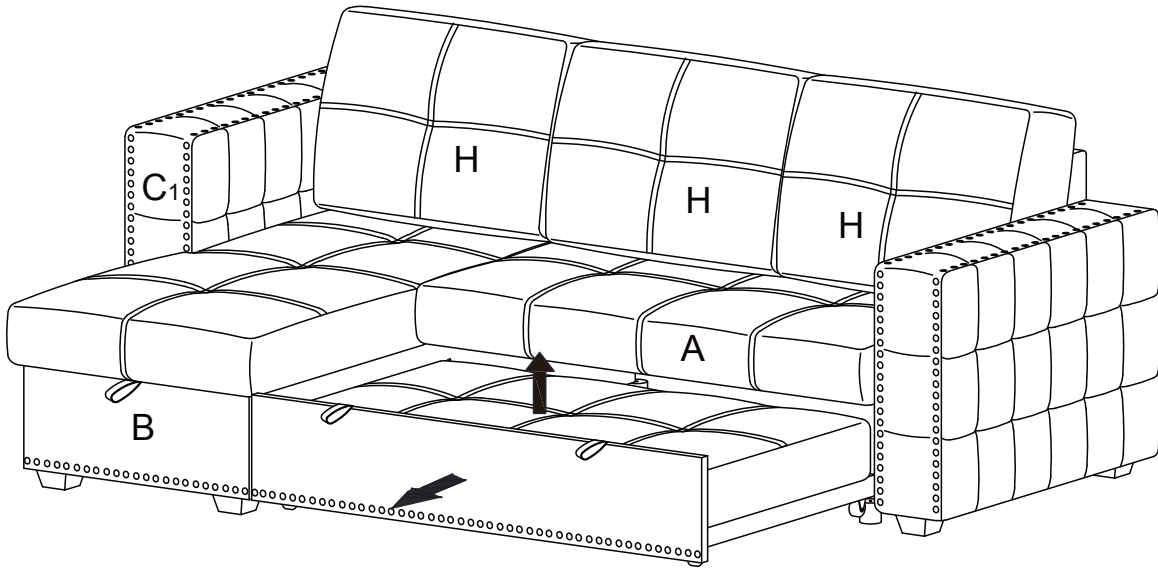

STEP6:

