

# **HICFM**

## **OWNER'S MANUAL**

### **30" TILTING PEDESTAL FAN**

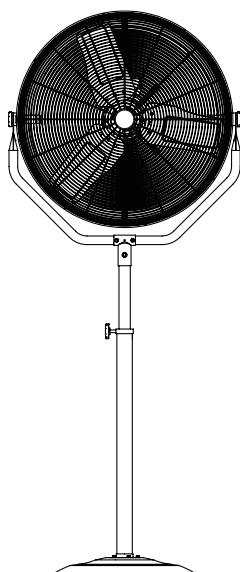

**ITEM NO.: FAN-P30T**

**120V / 60Hz, 1.95A**

**READ & SAVE THESE INSTRUCTIONS**

Questions, problems, missing parts? Before returning the product,

please e-mail our customer service by

**[hicfm@outlook.com](mailto:hicfm@outlook.com)**

## SAFETY INFORMATION

### WARNING

1. Read and save these instructions. Do not operate fan unless you have read these instructions.
2. Unplug the fan before moving it or performing maintenance. Do not touch the fan when your hands are wet.
3. Those who are not qualified electricians should not disassemble, repair or rebuild the fan.
4. Unplug the fan when it is not in use.
5. DO NOT unplug the fan by pulling the cable cord. Unplug by holding the plug and pulling.
6. DO NOT use the fan when there is damage to the cable cord or plug. If the supply cord is damaged, it has to be replaced by the manufacturer, its service agent or similarly qualified persons.
7. To Reduce The Risk Of Fire, Electric Shock Or Injury To Persons, Do Not Use Replacement Parts That Have Not Been Recommended By The Manufacturer (e.g. Parts Made At Home Using A 3D Printer).
8. DO NOT use the fan close to fires.
9. DO NOT insert your hand or other objects into the grille or the movable parts.
10. To reduce the risk of fire or electric shock, do not use this fan with any solid-state speed control device.
11. DO NOT use this fan outdoors, this fan is designed for indoor use only.
12. To Reduce The Risk Of Fire Or Electric Shock Do Not Use With An Extension Cord.

### CAUTION

1. Unplug the fan from the socket and clean it with a soft cloth.
2. DO NOT immerse the fan.
3. Fit the guard onto fan before starting up the fan.
4. This fan is not intended for use by people (including children) with reduced physical, sensory or mental capabilities or lack of experience and knowledge unless they have been given supervision or instruction concerning use of the fan by a person responsible for their safety. Supervise children to ensure they do not play with the fan.

## ASSEMBLY INSTRUCTION

1. Remove the base from the fan head by removing the screws.

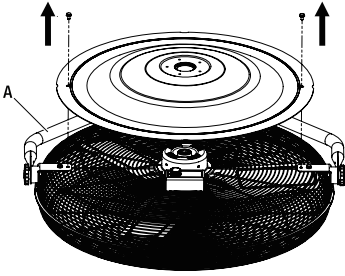

2. Loosen the height adjusting knob on the standing pole. Then pull the upper portion of the standing pole to the desired height and re-tighten the adjusting knob.

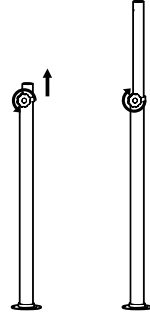

3. Insert the spring into the bottom of the standing pole. Then attach the standing pole to the base using the screws.

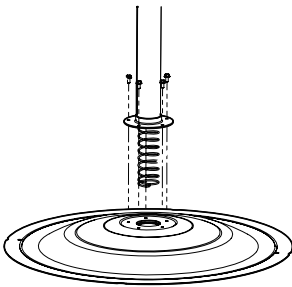

4. Place the fan head on top of the standing pole and secure in place using the long bolt and nut.

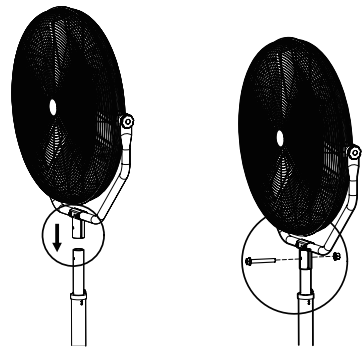

## OPERATION INSTRUCTION

1. Place the fan on a safe, flat surface where it can not fall or be pulled by the cord.
2. Adjust the desired speed by rotating the switch knob at the back of fan.  
0 Stop      1 Low      2 Medium      3 High

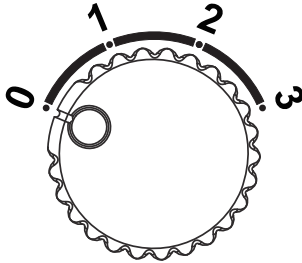

3. To adjust the angle of the fan head, loosen the two fan head knobs, tilt the fan head to the desired angle, and re-tighten the fan head knobs.

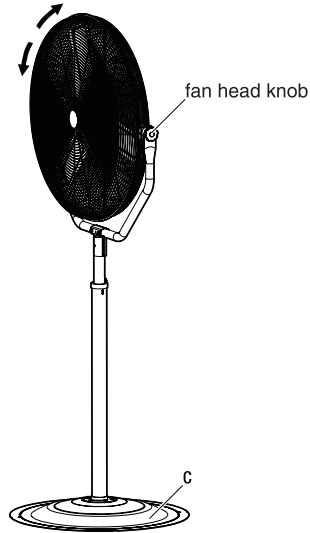

## **CARE AND MAINTENANCE**

Unplug the appliance before cleaning. Don't use any water for cleaning metal surfaces. Slightly moisten a cloth and then wipe off the surfaces of the fan. In order to remove dust from the grill, use a vacuum cleaner or remove the front grill by removing the securing screws on the edge of the grill. After cleaning, remount the grill. After doing this, fasten the screws on the edge of the grill.

## **1-YEAR LIMITED WARRANTY**

The manufacturer warrants this product to be free from manufacturing defects in the material and workmanship under normal use for a period of one year after the date of purchase by the original purchaser.

This warranty does not cover transit damages. This warranty does not apply to damages from accident, misuse, alteration of any kind to the fan or where the connected voltage is more than above the nameplate voltage. This warranty does not apply to the finish on any portion of the product. Servicing performed by unauthorized persons shall render the warranty invalid. The warranty is not responsible for damages of any kind, including accident and consequential damages. Some states do not allow the exclusion or limitation of the incidental or consequential damages, so the above exclusion or limitation may not apply to you. This warranty gives you specific legal rights, and you may also have other rights which vary from state to state.

## REPLACEMENT PARTS LIST

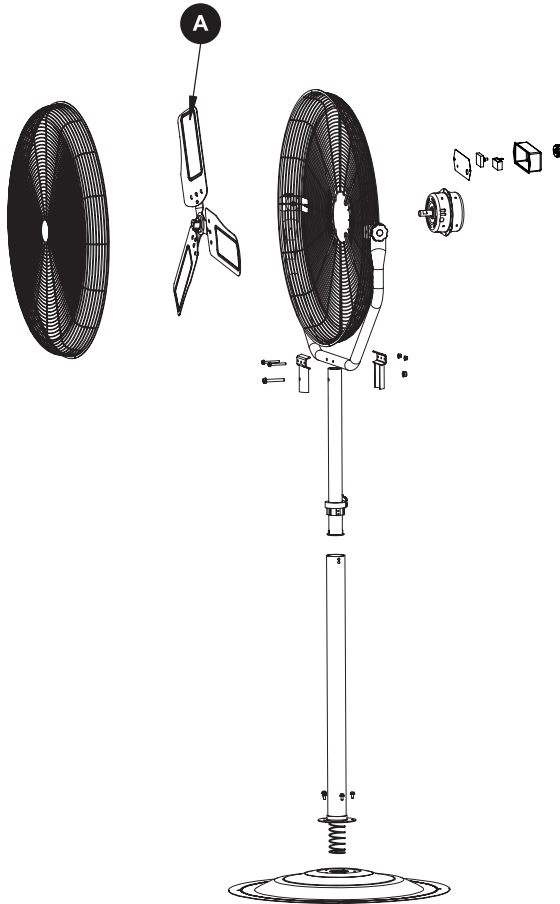

PART	DESCRIPTION	PART #
A	Blade	FAN-P30T