

OREGON®

**CHAINSAW PARTS
& ACCESSORIES**

SAW CHAIN REPLACEMENT PARTS GUIDE

Oregon® premium parts work with all major chainsaw brands.

**3 WAYS TO
FIND YOUR
REPLACEMENT
CHAIN**



GOLD ID LINK

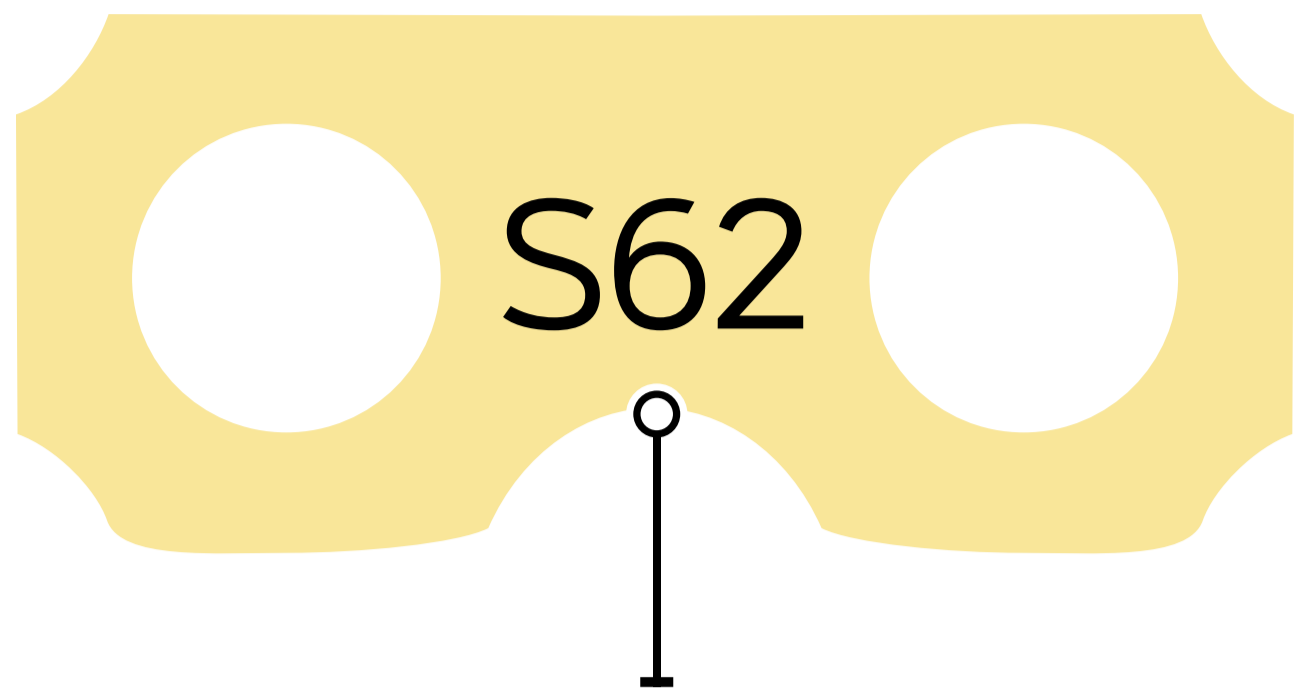

REPLACEMENT PART NUMBER

If the chain you are replacing is an Oregon® product, there may be a Gold ID Link indicating the replacement part number.

The Oregon® part number is boldly displayed in the red field on packaging.



BRAND & MODEL NO.

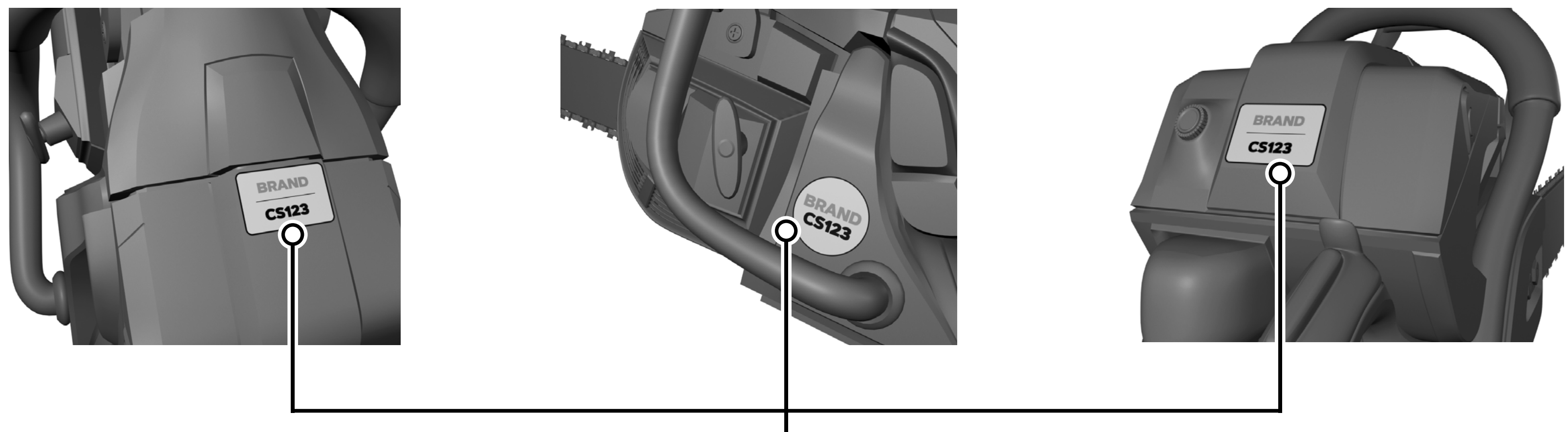

BRAND & MODEL NO. CAN BE FOUND ON SAW

BRAND INDEX

BLACK+DECKER®	HOMELITE®	REMINGTON®
BLUE MAX®	HUSQVARNA®	RYOBI®
CHICAGO ELECTRIC®	JOHN DEERE®	SENIX®
CORONA® CLIPPER	JONSERED®	SHINDAIWA®
CRAFTSMAN®	KOBALT®	SKIL®
CUB CADET®	MAKITA®	SOLO®
DAYTON®	MCCULLOCH®	STIHL®
DEWALT®	MILWAUKEE®	SUN JOE®
DOLMAR®	OLEO-MAC®	TANAKA®
EARTHQUAKE®	OREGON®	TORO®
EARTHWISE®	PARTNER®	TROY-BILT®
ECHO®	PIONEER®	WEN / WAGNER®
EFCO® - EMAX®	POULAN®	WESTERN AUTO®
EGO®	POULAN PRO®	WORX®
GREENWORKS®	POWERHORSE®	YARDWORKS®
HITACHI®	REDMAX®	

1

STEP 1

Find your brand in the chainsaw brand index.

STEP 2

Locate your chainsaw model under your brand. Your Oregon® replacement saw chain number is in red.

STEP 3

Confirm bar length and drive link count.

(SELECTOR CHART EXAMPLE)

ECHO®	OREGON® SAW CHAIN PART NO.	BAR LENGTH	DRIVE LINKS	GAUGE	PITCH	OF BAR C PA
CS-620P, CS-620PW, CS-451, CS-452, CS-500EVL, CS-510EVL, CS-590, CS-60, CS-600P, CS-601, CS-602, CS-60S, CS-650, CS-660, CS-670, CS-6700, CS-680, CS-701, CS-702, CS-706, CS-750, CS-8000, CS-T610	D60	16"	60	.050"	3/8"	27
	D66	18"	66	.050"	3/8"	30
	D70	20"	70	.050"	3/8"	27
	D81	24"	81	.050"	3/8"	39
DCS-5000-18C2	S62	18"	62	.050"	3/8"	39

2

3



BAR LENGTH

To find your length, just measure exposed bar.

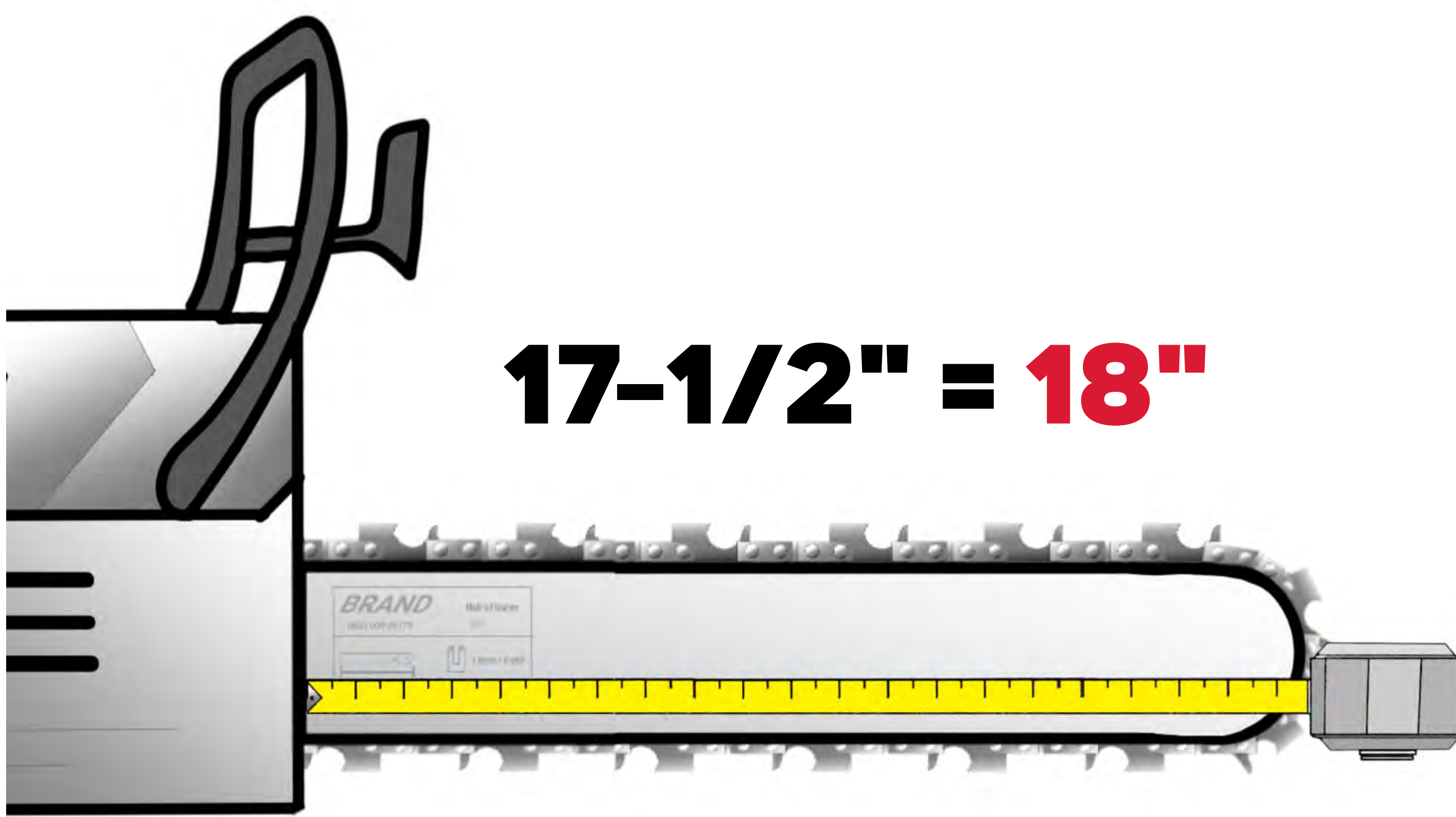

Round up to nearest even number.

DRIVE LINK COUNT

To find the number of drive links, count all the links on chain loop.

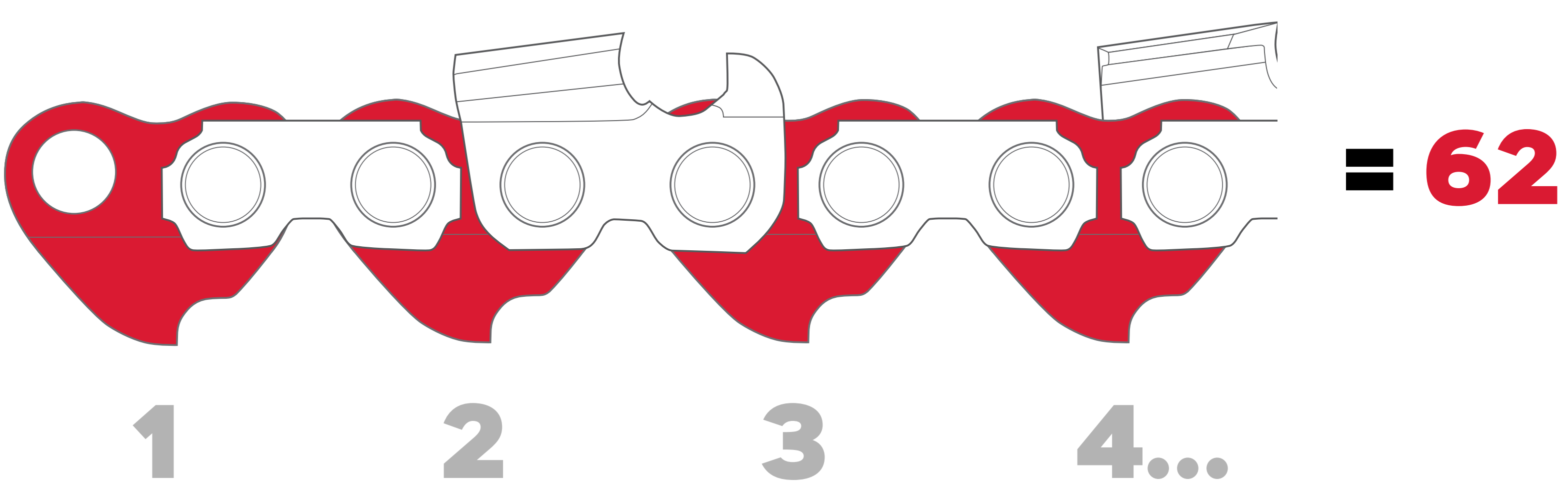

DRIVE LINK STAMP

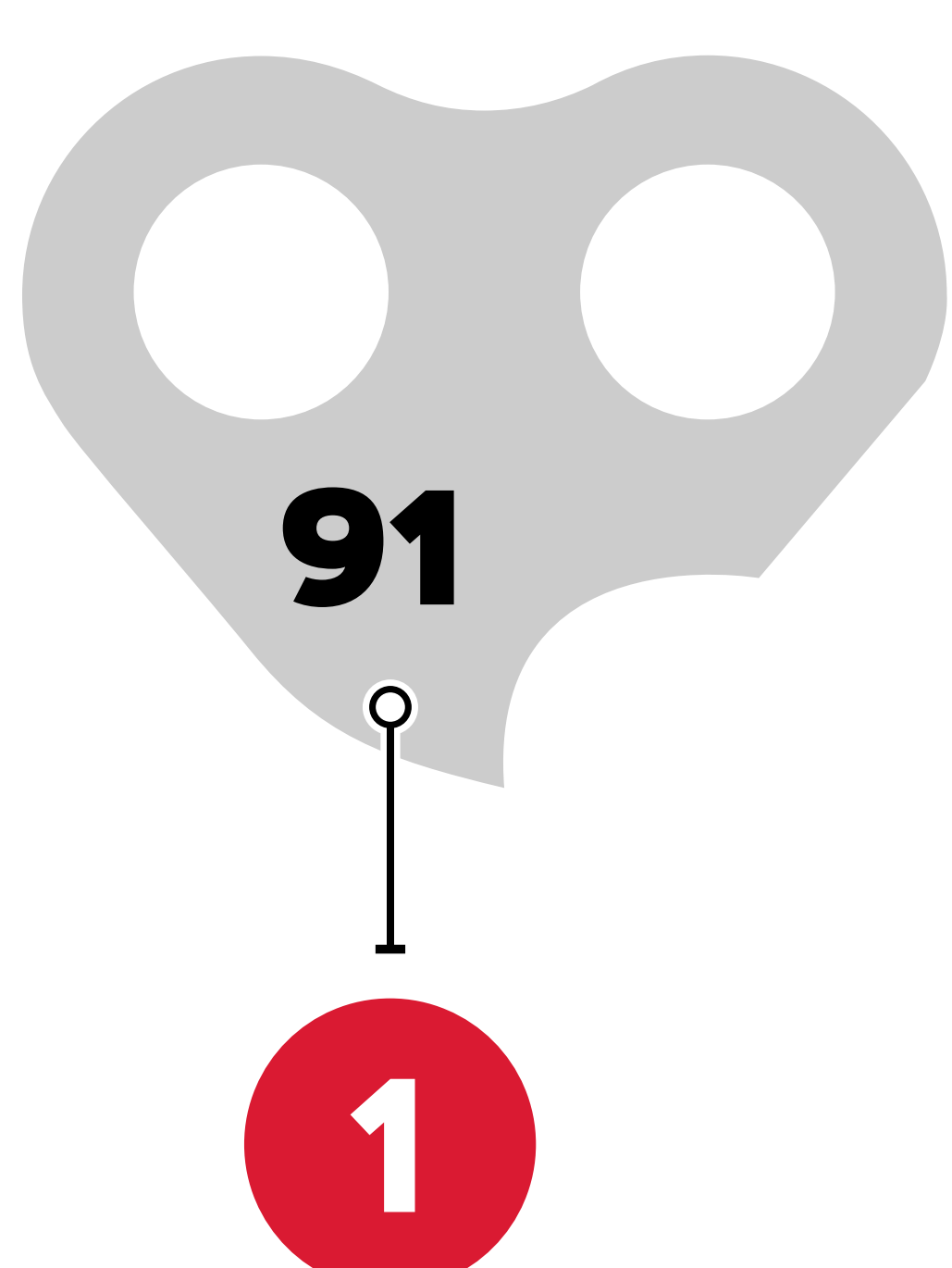

STEP 1:

Locate the drive link stamp on your old chain.

STEP 2:

Find your chain brand and your drive link stamped number in the chart below. Your Oregon® saw chain letter is in red.

STEP 3:

Count your drive links.

2

OREGON®

91 = S, T

3

COUNT YOUR DRIVE LINKS

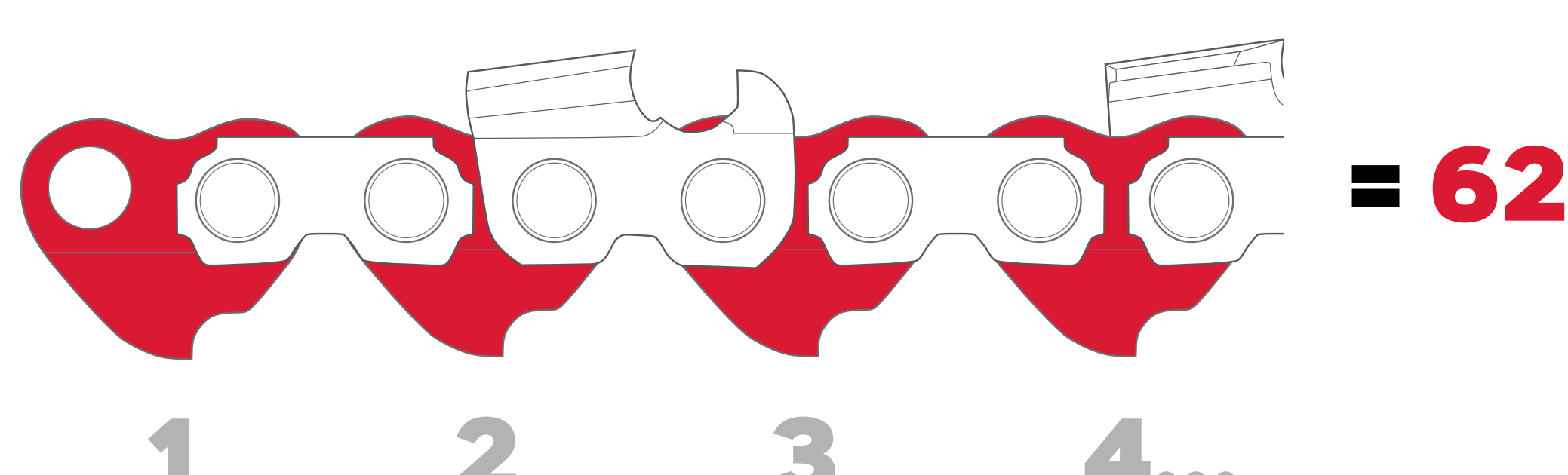

S + 62 = S62



OREGON®		
20 =	H, Q	
21 =	J	
22 =	L, V	
25 =	A	
33 =	H, Q	
34 =	J	
35 =	L, V	
72 =	B, D, E	
73 =	P	
76 =	B, D, E	
80 =	N	
90 =	R	
91 =	S, T	
95 =	G, M	

POWERCARE®		
1A =	R	
1B =	S, T	
2B =	H, Q	
2C =	J	
2D =	L, V	
3B =	B, D, E	
3C =	P	
7B =	H, Q	
7C =	J	
7D =	L, V	
8B =	B, D, E	
8C =	P	
G3 =	H, Q	
H3 =	B, D, E	
R1 =	R	
R3 =	S, T	

HUSQVARNA®			
00 =	A	42 =	P
21 =	J	46 =	B, D, E
22 =	H, Q	47 =	B, D, E
23 =	H, Q	48 =	P
25 =	J	49 =	P
26 =	L, V	51 =	B, D, E
28 =	L, V	54 =	P
30 =	G, M	55 =	P
35 =	S, T	80 =	B, D, E
36 =	S, T	81 =	P
37 =	H, Q, S, T	82 =	B, D, E
38 =	J, R		

STIHL® CUTTER STAMP REQUIRED FOR STIHL® MATCH-UP		
3	1/4	= A
1	6	= R
3	2	= H, Q
5	2	= J
6	2	= L, V
3	3	= B, D, E
5	3	= P
3	6	= S, T



DOLMAR®	
082 =	H, Q
085 =	J
086 =	J
092 =	S, T
099 =	P
290 =	R
484 =	G, M
486 =	H, Q
496 =	B, D, E
786 =	L, V



CARLTON®	
A1 =	B, D, E
A2 =	P
E1 =	A
K1 =	G, H, M, Q
K2 =	J
K3 =	L, V
N1 =	S, T
N4 =	R



BRAND INDEX



BLACK+DECKER®	OREGON® SAW CHAIN PART NO. LOW KICKBACK	OREGON® SAW CHAIN PART NO. PRO	BAR LENGTH	DRIVE LINKS	GAUGE	PITCH	OREGON® BAR/CHAIN COMBO PART NO.	SAW CHAIN PART NO.	BAR/CHAIN COMBO PART NO.
ALLIGATOR LP 1000, LLP120	—	A42	6"	42	.050"	1/4"	—	1005489218	—
BECS601	S40	—	10"	40	.050"	3/8" LP	—	1006891567	—
BECS600	S52	—	14"	52	.050"	3/8" LP	—	1006797675	—
PP610	S40	—	10"	40	.050"	3/8" LP	—	1006891567	—
LOG HOG, LH1600	S56	—	16"	56	.050"	3/8" LP	—	1006608508	—
		T56	16"	56	.050"	3/8" LP	—	1003903695	—
CS1216	S57	—	16"	57	.050"	3/8" LP	—	638443	—
		T57	16"	57	.050"	3/8" LP	—	1003903690	—
CS1518	S62	—	18"	62	.050"	3/8" LP	39272	1006608653	1006891528
		T62	18"	62	.050"	3/8" LP	—	1003903688	—
CCS818, NPP2018, LCS120, LPP120	R34	—	8"	34	.043"	3/8" LP	—	1006891568	—
LCS1020, LCS1020B	R40	—	10"	40	.043"	3/8" LP	—	1006891540	—
LCS1240	R45	—	12"	45	.043"	3/8" LP	—	1006891533	—
BLUE MAX	OREGON® SAW CHAIN PART NO. LOW KICKBACK	OREGON® SAW CHAIN PART NO. PRO	BAR LENGTH	DRIVE LINKS	GAUGE	PITCH	OREGON® BAR/CHAIN COMBO PART NO.	SAW CHAIN PART NO.	BAR/CHAIN COMBO PART NO.
MENCS18 (SILVER STEEL G4500)	—	J72	18"	72	.058"	.325"	—	1001229308	—
CHICAGO ELECTRIC®	OREGON® SAW CHAIN PART NO. LOW KICKBACK	OREGON® SAW CHAIN PART NO. PRO	BAR LENGTH	DRIVE LINKS	GAUGE	PITCH	OREGON® BAR/CHAIN COMBO PART NO.	SAW CHAIN PART NO.	BAR/CHAIN COMBO PART NO.
67255	S52	—	14"	52	.050"	3/8" LP	27856	1006797675	1006891534
		T52	14"	52	.050"	3/8" LP	—	1003903685	—
POLE SAW									
68862	S33	—	8"	33	.050"	3/8" LP	—	1006891544	—
CORONA® CLIPPER	OREGON® SAW CHAIN PART NO. LOW KICKBACK	OREGON® SAW CHAIN PART NO. PRO	BAR LENGTH	DRIVE LINKS	GAUGE	PITCH	OREGON® BAR/CHAIN COMBO PART NO.	SAW CHAIN PART NO.	BAR/CHAIN COMBO PART NO.
POLE SAW									
TP 400	S40	—	10" 12"	40	.050"	3/8" LP	—	1006891567	—
	S45	—	10" 12"	45	.050"	3/8" LP	—	1006891552	—
CRAFTSMAN®	OREGON® SAW CHAIN PART NO. LOW KICKBACK	OREGON® SAW CHAIN PART NO. PRO	BAR LENGTH	DRIVE LINKS	GAUGE	PITCH	OREGON® BAR/CHAIN COMBO PART NO.	SAW CHAIN PART NO.	BAR/CHAIN COMBO PART NO.
172.740500, S145, CMXGSAMNN4214, CMECS614	S52	—	14"	52	.050"	3/8" LP	27856	1006797675	1006891534
		T52	14"	52	.050"	3/8" LP	—	1003903685	—
172.34120	S63	—	18"	63	.050"	3/8" LP	—	1001229379	—
CMECS600, S160, CMXGSAMNN4216	S56	—	16"	56	.050"	3/8" LP	27857	1006608508	1006891576
		T56	16"	56	.050"	3/8" LP	—	1003903695	—
CMXGSAMY421S, S180, CMXGSAMCX4218	S62	—	18"	62	.050"	3/8" LP	39272	1006608653	1006891528
		T62	18"	62	.050"	3/8" LP	—	1003903688	—
CMXGSAMY462S	H78	—	20"	78	.050"	.325"	577330	1006797707	1006680591
		Q78	20"	78	.050"	.325"	—	—	—
MODEL NUMBERS BEGINNING WITH PREFIX 316.-									
34107	S55	—	16"	55	.050"	3/8" LP	—	1006891531	—
		T55	16"	55	.050"	3/8" LP	—	1003903702	—
38188	H72	—	18"	72	.050"	.325"	—	1006797688	—
		Q72	18"	72	.050"	.325"	—	—	—
35022	H78	—	20"	78	.050"	.325"	577330	1006797707	1006680591
		Q78	20"	78	.050"	.325"	—	—	—
35084, 35085 Ⓢ INDICATES NARROW KERF.	—	M72 Ⓢ	18"	72	.050"	.325"	584408	1006891541	1003907263
38070	S57	—	16"	57	.050"	3/8" LP	—	638443	—
		T57	16"	57	.050"	3/8" LP	—	1003903690	—
MODEL NUMBERS BEGINNING WITH PREFIX 358.-									
3407, 3411, 3412, 3425, 3445, 3455, 3476, 34094, 34101, 34102, 34104, 34106, 34108, 34109, 34111, 34114, 34115, 34116, 34117, 34118, 34124, 34140, 34150, 34180, 34181, 34190, 34195, 35006, 35008, 35018, 35024, 35026, 35027, 35028, 35036, 35037, 35038, 35044, 35046, 35048, 35056, 35058, 35060, 35066, 35067, 35080, 35081, 35082, 35083, 35087, 35088, 35093, 35099, 35104, 35106, 35108, 35114, 35115, 35116, 35117, 35118, 35134, 35136, 35138, 35144, 35145, 35146, 35148, 35156, 35158, 35160, 35161, 35170, 35171, 35180, 35181, 35182, 35190, 35191, 35198, 35202, 35203, 35205, 35206, 35207, 35215, 35216, 35218, 35231, 35235, 35238, 35263, 35266, 35267, 35268, 35269, 35270, 35273, 35280, 35281, 35283, 35363, 35366, 35367, 35504, 35505, 35506, 35508, 35512, 35514, 35515, 35516, 35618, 35623, 35624, 35718, 35723, 35736, 35802, 36010, 36012, 36013, 36015, 36017, 36018, 36026, 36028, 36036, 36038, 36068, 36069, 36080, 36082, 36083, 36085, 36087, 36088, 36218, 38160, 38170, CMXGSAMNN4214, CMXGSAMNN4216	S40	—	10"	40	.050"	3/8" LP	—	1006891567	—
	S45	—	12"	45	.050"	3/8" LP	27792	1006891552	1005490840
	S52	—	14"	52	.050"	3/8" LP	27856	1006797675	1006891534
		T52	14"	52	.050"	3/8" LP	—	1003903685	—
	S56	—	16"	56	.050"	3/8" LP	27857	1006608508	1006891576
		T56	16"	56	.050"	3/8" LP	—	1003903695	—
	S62	—	18"	62	.050"	3/8" LP	39272	1006608653	1006891528
		T62	18"	62	.050"	3/8" LP	—	1003903688	—
34119	S55	—	16"	55	.050"	3/8" LP	—	1006891531	—
		T55	16"	55	.050"	3/8" LP	—	1003903702	—
35618, 35623, 35238, 41CY4218793	S62	—	18"	62	.050"	3/8" LP	39272	1006608653	1006891528
		T62	18"	62	.050"	3/8" LP	—	1003903688	—
35212, 35483, 35487, 35608, 35609, 35690, 35885, 35887, 35889	D60	—	16"	60	.050"	3/8"	27851	1004774736	1004806822
	B60, E60	—	16"	60	.050"	3/8"	—	1003903698	—
	D66	—	18"	66	.050"	3/8"	30159	1001250428	1005490837
	B66, E66	—	18"	66	.050"	3/8"	—	1003903699	—
	D70	—	20"	70	.050"	3/8"	27850	1001229297	1003907271
	B70, E70	—	20"	70	.050"	3/8"	—	1006891572	—
	D81	—	24"	81	.050"	3/8"	—	1001229306	—
35098 ‡ CHOOSE THE REPLACEMENT PARTS IN THIS LINE ONLY IF THE ORIGINAL GUIDE BAR ON YOUR SAW HAS BEEN REPLACED WITH AN OREGON REPLACEMENT GUIDE BAR AT THIS LENGTH.	D70	—	20"	70	.050"	3/8"	—	1001229297	—
	B70, E70	—	20"	70	.050"	3/8"	—	1006891572	—
	D72	—	20" ‡	72	.050"	3/8"	584818	1006608716	1005490838
	B72, E72	—	20" ‡	72	.050"	3/8"	—	1006891543	—
35607, 35119, 35628	H72	—	18"	72	.050"	.325"	36892	1006797688	1003907269
	Q72	—	18"	72	.050"	.325"	—	—	—
35020, 35021, 35120, 35121, 35492, 35633, CMXGSAMY462S	H78	—	20"	78	.050"	.325"	37977	1006797707	1006891535
	Q78	—	20"	78	.050"	.325"	—	—	—
38180 Ⓢ INDICATES NARROW KERF.	—	M72 Ⓢ	18"	72	.050"	.325"	584408	1006891541	1003907263
38200 Ⓢ INDICATES NARROW KERF.	—	M80 Ⓢ	20"	80	.050"	.325"	—	1006891575	—
POLE SAW									
CMCCSP20M1	R34	—	8"	34	.043"	3/8" LP	—	1006891568	—
151.74326	S33	—	8"	33	.050"	3/8" LP	—	1006891544	—
43983, 172.43983, CMCCS610D1, CMXGJAMD25PS	S40	—	10"	40	.050"	3/8" LP	—	1006891567	—
79240, 79245, 79246	R34	—	8"	34	.043"	3/8" LP	—	1006891568	—
	R40	—	10"	40	.043"	3/8" LP	—	1006891540	—
CORDLESS ELECTRIC									
98946	S45	—	12"	45	.050"	3/8" LP	27792	1006891552	1005490840
34130, 34131	R40	—	10"	40	.043"	3/8" LP	—	1006891540	—
98023, CMCCS620, CMCCS620M1	R45	—	12"	45	.043"	3/8" LP	—	1006891533	—
CMCCS660, CMCCS660E1, CMECS660, CMECS660E1	R56	—	16"	56	.043"	3/8" LP	—	1006608707	—
CORDED ELECTRIC									
CMECSP610	S40	—	10"	40	.050"	3/8" LP	—	1006891567	—
CMECS614	S52	—	14"	52	.050"	3/8" LP	27856	1006797675	1006891534
		T52	14"	52	.050"	3/8" LP	—	1003903685	—
CMECS600	S56	—	16"	56	.050"	3/8" LP	27857	1006608508	1006891576
		T56	16"	56	.050"	3/8" LP	—	1003903695	—

CUB CADET®			OREGON® SAW CHAIN PART NO. LOW KICKBACK	OREGON® SAW CHAIN PART NO. PRO	BAR LENGTH	DRIVE LINKS	GAUGE	PITCH	OREGON® BAR/CHAIN COMBO PART NO.	SAW CHAIN PART NO.	BAR/CHAIN COMBO PART NO.
CS3916 <small>† CHOOSE THE REPLACEMENT PARTS IN THIS LINE ONLY IF THE ORIGINAL GUIDE BAR ON YOUR SAW HAS BEEN REPLACED WITH AN OREGON REPLACEMENT GUIDE BAR AT THIS LENGTH.</small>		S52		14"	52	.050"	3/8" LP	27856		1006797675	1006891534
			T52	14"	52	.050"	3/8" LP	—		1003903685	—
		S56		16" †	56	.050"	3/8" LP	27857		1006608508	1006891576
			T56	16" †	56	.050"	3/8" LP	—		1003903695	—
		S57		16"	57	.050"	3/8" LP	—		638443	—
				T57	16"	57	.050"	3/8" LP	—		1003903690
CS5018, CS5220		H66		16"	66	.050"	.325"	—		1004774734	—
			Q66	16"	66	.050"	.325"	—		—	—
		H72		18"	72	.050"	.325"	—		1006797688	—
			Q72	18"	72	.050"	.325"	—		—	—
		H78		20"	78	.050"	.325"	577330		1006797707	1006680591
			Q78	20"	78	.050"	.325"	—		—	—
CS5720		D68		18"	68	.050"	3/8"	510124		1000579263	—
			B68, E68	18"	68	.050"	3/8"	—		1003903697	—
		D72		20"	72	.050"	3/8"	584818		1006608716	1005490838
			B72, E72	20"	72	.050"	3/8"	—		1006891543	—
		D84		24"	84	.050"	3/8"	—		—	—
		B84, E84	24"	84	.050"	3/8"	—		1006891539	—	
POLE SAW											
PS26		R40	—	10"	40	.043"	3/8" LP	—		1006891540	—
DAYTON			OREGON® SAW CHAIN PART NO. LOW KICKBACK	OREGON® SAW CHAIN PART NO. PRO	BAR LENGTH	DRIVE LINKS	GAUGE	PITCH	OREGON® BAR/CHAIN COMBO PART NO.	SAW CHAIN PART NO.	BAR/CHAIN COMBO PART NO.
2Z753, 2Z760, 2Z970, 4Z022, 4Z023, 4Z109, 4Z573, 4Z971, 4Z972, 6Z284, 6Z823		S40	—	10"	40	.050"	3/8" LP	—		1006891567	—
		S45	—	12"	45	.050"	3/8" LP	27792		1006891552	1005490840
		S52		14"	52	.050"	3/8" LP	27856		1006797675	1006891534
			T52	14"	52	.050"	3/8" LP	—		1003903685	—
		S56		16"	56	.050"	3/8" LP	27857		1006608508	1006891576
			T56	16"	56	.050"	3/8" LP	—		1003903695	—
		S62		18"	60	.050"	3/8" LP	39272		1006608653	1006891528
		T62	18"	60	.050"	3/8" LP	—		1003903688	—	
2Z462, 2Z462A, 2Z463, 2Z561, 2Z971, 4Z251, 4Z251A, 4Z252, 4Z397, 4Z973, 6Z826, 7Z627		D60		16"	60	.050"	3/8"	27851		1004774736	1004806822
			B60, E60	16"	60	.050"	3/8"	—		1003903698	—
		D66		18"	66	.050"	3/8"	30159		1001250428	1005490837
			B66, E66	18"	66	.050"	3/8"	—		1003903699	—
		D70		20"	70	.050"	3/8"	27850		1001229297	1003907271
			B70, E70	20"	70	.050"	3/8"	—		1006891572	—
		D72		21"	72	.050"	3/8"	—		1006608716	—
			B72, E72	21"	72	.050"	3/8"	—		1006891543	—
	D81	—	24"	81	.050"	3/8"	—		1001229306	—	
DEWALT®			OREGON® SAW CHAIN PART NO. LOW KICKBACK	OREGON® SAW CHAIN PART NO. PRO	BAR LENGTH	DRIVE LINKS	GAUGE	PITCH	OREGON® BAR/CHAIN COMBO PART NO.	SAW CHAIN PART NO.	BAR/CHAIN COMBO PART NO.
DCCS690M1, DCCS690B, DCCS690H1, DCCS690X1		R56	—	16"	56	.043"	3/8" LP	623000		1006608707	1006891558
DCCS620B, DCCS620P1		R45	—	12"	45	.043"	3/8" LP	—		1006891533	—
DOLMAR®			OREGON® SAW CHAIN PART NO. LOW KICKBACK	OREGON® SAW CHAIN PART NO. PRO	BAR LENGTH	DRIVE LINKS	GAUGE	PITCH	OREGON® BAR/CHAIN COMBO PART NO.	SAW CHAIN PART NO.	BAR/CHAIN COMBO PART NO.
ES171, ES173, PS32, PS3300TH, PS34, PS341, PS3410 TH, PS3410TH TLC, PS35, PS350, PS401, PS420, PS45		S52		14"	52	.050"	3/8" LP	27856		1006797675	1006891534
			T52	14"	52	.050"	3/8" LP	—		1003903685	—
		S56		16"	56	.050"	3/8" LP	27857		1006608508	1006891576
		T56	16"	56	.050"	3/8" LP	—		1003903695	—	
109*, 110*, 111*, 112*, 113*, 114*, 116*, 116SI*, 117*, 119*, 120*, PS-460*, PS-510*, PS-540*, PS-5100S*, PS-5105*, PS-5105H*, PS-6100*, PS-6100H*		H66		16"	66	.050"	.325"	—		1004774734	—
			Q66	16"	66	.050"	.325"	—		—	—
		H72		18"	72	.050"	.325"	—		1006797688	—
			Q72	18"	72	.050"	.325"	—		—	—
		—	J64	15"	64	.058"	.325"	—		1005489220	—
		—	J66	16"	66	.058"	.325"	—		—	—
		—	J72	18"	72	.058"	.325"	—		1001229308	—
		D60		16"	60	.050"	3/8"	—		1004774736	—
			B60, E60	16"	60	.050"	3/8"	—		1003903698	—
		D68		18"	68	.050"	3/8"	510124		1000579263	—
			B68, E68	18"	68	.050"	3/8"	—		1003903697	—
		D72		20"	72	.050"	3/8"	584271		1006608716	1004806825
			B72, E72	20"	72	.050"	3/8"	—		1006891543	—
		D84		24"	84	.050"	3/8"	—		—	—
		B84, E84	24"	84	.050"	3/8"	—		1006891539	—	
	P60	—	16"	60	.058"	3/8"	—		—	—	
PS-6800I†		D60		16"	60	.050"	3/8"	—		1004774736	—
			B60, E60	16"	60	.050"	3/8"	—		1003903698	—
		D68		18"	68	.050"	3/8"	510124		1000579263	—
			B68, E68	18"	68	.050"	3/8"	—		1003903697	—
		D72		20"	72	.050"	3/8"	584271		1006608716	1004806825
			B72, E72	20"	72	.050"	3/8"	—		1006891543	—
		D84		24"	84	.050"	3/8"	—		—	—
		B84, E84	24"	84	.050"	3/8"	—		1006891539	—	
	P60	—	16"	60	.058"	3/8"	—		—	—	
PS-6400, PS-6400H, PS-6400W, PS-7300, PS-7300H, PS-7300W, PS-7310, PS-7310H, PS-7900, PS-7900H, PS-7900W, PS-7910, PS-7910H, PS-7910W, PS-7910XD, PS-9000, PS-9010		D72		20"	72	.050"	3/8"	—		1006608716	—
			B72, E72	20"	72	.050"	3/8"	—		1006891543	—
		D84		24"	84	.050"	3/8"	—		—	—
			B84, E84	24"	84	.050"	3/8"	—		1006891539	—
EARTHQUAKE®			OREGON® SAW CHAIN PART NO. LOW KICKBACK	OREGON® SAW CHAIN PART NO. PRO	BAR LENGTH	DRIVE LINKS	GAUGE	PITCH	OREGON® BAR/CHAIN COMBO PART NO.	SAW CHAIN PART NO.	BAR/CHAIN COMBO PART NO.
CS3816, CS4116, CS3814		S52		14"	52	.050"	3/8" LP	27856		1006797675	1006891534
			T52	14"	52	.050"	3/8" LP	—		1003903685	—
		S56		16"	56	.050"	3/8" LP	27857		1006608508	1006891576
			T56	16"	56	.050"	3/8" LP	—		1003903695	—
		S62		18"	62	.050"	3/8" LP	39272		1006608653	1006891528
		T62	18"	62	.050"	3/8" LP	—		1003903688	—	
CS4518, CS4518B		S62		18"	62	.050"	3/8" LP	—		1006608653	—
			T62	18"	62	.050"	3/8" LP	—		1003903688	—
EARTHWISE™			OREGON® SAW CHAIN PART NO. LOW KICKBACK	OREGON® SAW CHAIN PART NO. PRO	BAR LENGTH	DRIVE LINKS	GAUGE	PITCH	OREGON® BAR/CHAIN COMBO PART NO.	SAW CHAIN PART NO.	BAR/CHAIN COMBO PART NO.
CCS 30008, CPS40108, CVPS41008, LPS40208, NVPS42108, PS40008		S33	—	8"	33	.050"	3/8" LP	—		1006891544	—
CPS40110, LCS32010, LPS4210, PS40010		S40	—	10"	40	.050"	3/8" LP	—		1006891567	—
LCS32413		S45	—	12"	45	.050"	3/8" LP	27792		1006891552	1005490840
CS30014, LCS34014, LCS35814, YT4729		S45	—	12"	45	.050"	3/8" LP	27792		1006891552	1005490840
		S52		14"	52	.050"	3/8" LP	27856		1006797675	1006891534
			T52	14"	52	.050"	3/8" LP	—		1003903685	—
MIL-KW-305		S53	—	14"	53	.050"	3/8" LP	—		1003903706	—
CS30016, CS30116		S57		14"	57	.050"	3/8" LP	—		638443	—
			T57	14"	57	.050"	3/8" LP	—		1003903690	—

EGO™	OREGON® SAW CHAIN PART NO. LOW KICKBACK	OREGON® SAW CHAIN PART NO. PRO	BAR LENGTH	DRIVE LINKS	GAUGE	PITCH	OREGON® BAR/CHAIN COMBO PART NO.	 SAW CHAIN PART NO.	 BAR/CHAIN COMBO PART NO.
MPS1000	R40	—	10"	40	.043"	3/8" LP	—	1006891540	—
CS1400, CS1401	R52	—	14"	52	.043"	3/8" LP	27856	1006891537	1006891534
CS1804	S62	—	18"	62	.050"	3/8" LP	39272	1006608653	1006891528
	—	T62	18"	62	.050"	3/8" LP	—	1003903688	—

GREENWORKS®	OREGON® SAW CHAIN PART NO. LOW KICKBACK	OREGON® SAW CHAIN PART NO. PRO	BAR LENGTH	DRIVE LINKS	GAUGE	PITCH	OREGON® BAR/CHAIN COMBO PART NO.	 SAW CHAIN PART NO.	 BAR/CHAIN COMBO PART NO.
POLE SAW									
GLPS80210	A58	—	10"	58	.050"	1/4"	—	—	—
1400102 24V LI-ION, 20192 6.5A, 20302 40V G-MAX, 20352 24V LI-ION, 20612 20V LI-ION, 20672 40V G-MAX, PSPH40B00	S33	—	8"	33	.050"	3/8" LP	—	1006891544	—
20062 7A 2-IN-1, 20362 24V LI-ION, 2000102 24V LI-ION, 20V LI-ION, PSCS06B00	S40	—	10"	40	.050"	3/8" LP	—	1006891567	—
20202 40V G-MAX, 20262 40V G-MAX, 20292 40V G-MAX, 20082 40V, 20297 40V G-MAX	S45	—	12"	45	.050"	3/8" LP	27792	1006891552	1005490840
20012 9A ELECTRIC 20222 9A ELECTRIC	S52	—	14"	52	.050"	3/8" LP	27856	1006797675	1006891534
	—	T52	14"	52	.050"	3/8" LP	—	1003903685	—
20022 12A, 20232 12A, CS60L00, CS60L210, 2002802, CS60L212	S56	—	16"	56	.050"	3/8" LP	27857	1006608508	1006891576
	—	T56	16"	56	.050"	3/8" LP	—	1003903695	—
GCS80420, GCS80421, 200002 80V	S62	—	18"	62	.050"	3/8" LP	39272	1006608653	1006891528
	—	T62	18"	62	.050"	3/8" LP	—	1003903688	—
20032 13A, 20332 14.5	S63	—	18"	63	.050"	3/8" LP	—	1001229379	—
20152 DIGIPRO 40V, 20312 DIGIPRO G-MAX 40V, 20322 DIGIPRO G-MAX 40V	R56	—	16"	56	.043"	3/8" LP	623000	1006608707	1006891558

HITACHI	OREGON® SAW CHAIN PART NO. LOW KICKBACK	OREGON® SAW CHAIN PART NO. PRO	BAR LENGTH	DRIVE LINKS	GAUGE	PITCH	OREGON® BAR/CHAIN COMBO PART NO.	 SAW CHAIN PART NO.	 BAR/CHAIN COMBO PART NO.
CS36DLP4	S45	—	12"	45	.050"	3/8" LP	27792	1006891552	1005490840
CS33ET14, CS33EB16	S52	—	14"	52	.050"	3/8" LP	27856	1006797675	1006891534
	—	T52	14"	52	.050"	3/8" LP	—	1003903685	—
	S57	—	16"	57	.050"	3/8" LP	—	638443	—
	—	T57	16"	57	.050"	3/8" LP	—	1003903690	—
CS40EA18 <small>Ⓜ INDICATES NARROW KERF.</small>	—	M72 Ⓜ	18"	72	.050"	.325"	—	1006891541	—
CS51EAP <small>Ⓜ INDICATES NARROW KERF.</small>	H78	—	20"	78	.050"	.325"	37977	1006797707	1006891535
	—	Q78	20"	78	.050"	.325"	—	—	—
	—	M66 Ⓜ	16"	66	.050"	.325"	—	1006891545	—
	—	M72 Ⓜ	18"	72	.050"	.325"	—	1006891541	—

HOMELITE®	OREGON® SAW CHAIN PART NO. LOW KICKBACK	OREGON® SAW CHAIN PART NO. PRO	BAR LENGTH	DRIVE LINKS	GAUGE	PITCH	OREGON® BAR/CHAIN COMBO PART NO.	 SAW CHAIN PART NO.	 BAR/CHAIN COMBO PART NO.
20, 20AV, 23, 23AV, 3300, 3314, 3316, 3318, 3350, 3550, 3800, 3850, PS33, RANGER, UT0901A, UT10510, UT10514, UT10516, UT10517, UT10530, UT10530A, UT10540, UT10542, UT10544, UT10546, UT10548, UT10549, UT10560, UT10562, UT10564, UT10566, UT10568, UT10569, UT10580, UT10582, UT10584, UT10586, UT10588, UT10589, UT10640, UT10660, UT10680, UT10901, UT10926, UT10947A, UT10947D, UT43100, UT43102, UT43103, UT43104, UT43120, UT43122, ZR10540, ZR10560, ZR10580	S52	—	14"	52	.050"	3/8" LP	27856	1006797675	1006891534
	—	T52	14"	52	.050"	3/8" LP	—	1003903685	—
	S56	—	16"	56	.050"	3/8" LP	27857	1006608508	1006891576
	—	T56	16"	56	.050"	3/8" LP	—	1003903695	—
	S62	—	18"	62	.050"	3/8" LP	39272	1006608653	1006891528
	—	T62	18"	62	.050"	3/8" LP	—	1003903688	—
EL12, EL14, EL16	S45	—	12"	45	.050"	3/8" LP	—	1006891552	—
	S50	—	14"	50	.050"	3/8" LP	—	1006891547	—
	—	T50	14"	50	.050"	3/8" LP	—	1003903703	—
	S56	—	16"	56	.050"	3/8" LP	—	1006608508	—
	—	T50	16"	56	.050"	3/8" LP	—	1003903703	—
180, 190, 192, 200, 200 ELECTRIC, 245 (BEFORE XE339), BANDIT, CLASSIC 192, LITTLE RED, LX30, SUPER 2, SUPER 2CC, VI SUPER 2, XEL-14, XEL, XL, XL 2 (AFTER SERIAL # 5042001), XL-10, XL-14, XL-16, XL2CC	S48	—	12"	48	.050"	3/8" LP	—	1004774731	—
	S53	—	14"	53	.050"	3/8" LP	27859	1003903706	1004806828
	S59	—	16"	59	.050"	3/8" LP	30141	1003903701	1004806826
	S64	—	18"	64	.050"	3/8" LP	—	1004774729	—
245 (AFTER XE339), 252, 300	H67	—	16"	67	.050"	.325"	—	1005489221	—
	H73	—	18"	73	.050"	.325"	—	1004774735	—
130, 150, 150AO, 250, 300, 340, BIG RED, EZ 250, EZ SERIES, MINI SL, SUPER EZAO, V-15 MINI, S6, XL 76, XL 100 SERIES	D59	—	16"	59	.050"	3/8"	29571	1004774730	1003907273
	D70	—	20"	70	.050"	3/8"	—	1001229297	—
	—	B70, E70	20"	70	.050"	3/8"	—	1006891572	—
25, 27, 4100, 4150, 4500, 4550, SUPER 240, TIMBERMAN, UT10518, UT10519, UT10520, UT10522, UT10550, UT10552, UT10526, UT10927A, UT10942A, UT10946A, ZR10518, ZR10520, ZR10522	H66	—	16"	66	.050"	.325"	—	1004774734	—
	—	Q66	16"	66	.050"	.325"	—	—	—
	H72	—	18"	72	.050"	.325"	36892	1006797688	1003907269
	—	Q72	18"	72	.050"	.325"	—	—	—
	H78	—	20"	78	.050"	.325"	37977	1006797707	—
	—	Q78	20"	78	.050"	.325"	—	—	—

POLE SAW									
UT15520A EXACTFIT	R40	—	10"	40	.043"	3/8" LP	—	1006891540	—

HUSQVARNA®	OREGON® SAW CHAIN PART NO. LOW KICKBACK	OREGON® SAW CHAIN PART NO. PRO	BAR LENGTH	DRIVE LINKS	GAUGE	PITCH	OREGON® BAR/CHAIN COMBO PART NO.	SAW CHAIN PART NO.	BAR/CHAIN COMBO PART NO.
	34, 35, 37, 335, 325P4, 325P5X, 326P4, 326P5X, 334T, 316E, 1400, 1600, EL 316, T435, T540	S45	—	12"	45	.050"	3/8" LP	—	1006891552
S52		—	14"	52	.050"	3/8" LP	—	1006797675	—
—		T52	14"	52	.050"	3/8" LP	—	1003903685	—
S56		—	16"	56	.050"	3/8" LP	—	1006608508	—
—		T56	16"	56	.050"	3/8" LP	—	1003903695	—
65, 66, 70, 77, 181, 185, 260, 266, 268, 272, 281, 285, 288, 288XP, 298*, 365, 371, 372, 372XP, 372XPG, 372XPW, 380, 385XP, 390XP*, 390XPG*, 390XPW*, 394*, 395*, 395XPW*, 465 RANCHER, 480, 562XP, 565, 570, 572XP, 572XPG, 575XP, 575XPG, 575XPW, 576XP AUTO TUNE, 576XPW, 1100*, 2100*, 2101*, 3120*	D60	—	16"	60	.050"	3/8"	—	1004774736	—
	—	B60, E60	16"	60	.050"	3/8"	—	1003903698	—
	D68	—	18"	68	.050"	3/8"	—	1000579263	—
	—	B68, E68	18"	68	.050"	3/8"	—	1003903697	—
	D72	—	20"	72	.050"	3/8"	—	1006608716	—
	—	B72, E72	20"	72	.050"	3/8"	—	1006891543	—
	D84	—	24"	84	.050"	3/8"	—	—	—
	—	B84, E84	24"	84	.050"	3/8"	—	1006891539	—
	P60	—	16"	60	.058"	3/8"	—	—	—
	—	—	—	—	—	—	—	—	—
336*, 338XPT*, 339XPT*	S45	—	12"	45	.050"	3/8" LP	—	1006891552	—
	S52	—	14"	52	.050"	3/8" LP	—	1006797675	—
	—	T52	14"	52	.050"	3/8" LP	—	1003903685	—
	S56	—	16"	56	.050"	3/8" LP	—	1006608508	—
	—	T56	16"	56	.050"	3/8" LP	—	1003903695	—
	—	J66	16"	66	.058"	.325"	—	—	—
	—	J72	18"	72	.058"	.325"	—	1001229308	—
	H66	—	16"	66	.050"	.325"	—	1004774734	—
	—	Q66	16"	66	.050"	.325"	—	—	—
	H72	—	18"	72	.050"	.325"	—	1006797688	—
	—	Q72	18"	72	.050"	.325"	—	—	—
	—	M66 Ⓞ	16"	66	.050"	.325"	584410	1006891545	1003907264
	—	M72 Ⓞ	18"	72	.050"	.325"	584408	1006891541	1003907263
55 RANCHER*, 254*, 254XP*, 257*, 261*, 262*, 262XP*, 357XP*, 359*, 362*, 362XP*, 455 RANCHER*, 460 RANCHER*, 555*, 560XP*, 560XPG*	D60	—	16"	60	.050"	3/8"	—	1004774736	—
	—	B60, E60	16"	60	.050"	3/8"	—	1003903698	—
	D68	—	18"	68	.050"	3/8"	510124	1000579263	—
	—	B68, E68	18"	68	.050"	3/8"	—	1003903697	—
	D72	—	20"	72	.050"	3/8"	584271	1006608716	1004806825
	—	B72, E72	20"	72	.050"	3/8"	—	1006891543	—
	D84	—	24"	84	.050"	3/8"	—	—	—
	—	B84, E84	24"	84	.050"	3/8"	—	1006891539	—
	P60	—	16"	60	.058"	3/8"	—	—	—
	—	J66	16"	66	.058"	.325"	—	—	—
	—	J72	18"	72	.058"	.325"	—	1001229308	—
	—	J78	20"	78	.058"	.325"	—	1004774728	—
	H66	—	16"	66	.050"	.325"	—	1004774734	—
	—	Q66	16"	66	.050"	.325"	—	—	—
	H72	—	18"	72	.050"	.325"	—	1006797688	—
	—	Q72	18"	72	.050"	.325"	—	—	—
	H78	—	20"	78	.050"	.325"	—	1006797707	—
	—	Q78	20"	78	.050"	.325"	—	—	—
—	M66 Ⓞ	16"	66	.050"	.325"	584410	1006891545	1003907264	
—	M72 Ⓞ	18"	72	.050"	.325"	584408	1006891541	1003907263	
—	M78 Ⓞ	20"	78	.050"	.325"	—	1005489217	—	
—	M80 Ⓞ	20"	80	.050"	.325"	—	1006891575	—	
120I, 120 MARK II	S52	—	14"	52	.050"	3/8" LP	—	1006797675	—
	—	T52	14"	52	.050"	3/8" LP	—	1003903685	—
436LI, 536LI XP, T536LI XP	R40	—	10"	40	.043"	3/8" LP	—	1006891540	—
	R45	—	12"	45	.043"	3/8" LP	—	1006891533	—
	R52	—	14"	52	.043"	3/8" LP	—	1006891537	—
536LIP4, 536LIP5	S40	—	10"	40	.050"	3/8" LP	—	1006891567	—
136*, 137, 141*, 142*, 235*, 235E*, 240*, 240E*	R56	—	16"	56	.043"	3/8" LP	—	1006608707	—
	S52	—	14"	52	.050"	3/8" LP	27856	1006797675	1006891534
	—	T52	14"	52	.050"	3/8" LP	—	1003903685	—
	S56	—	16"	56	.050"	3/8" LP	27857	1006608508	1006891576
	—	T56	16"	56	.050"	3/8" LP	—	1003903695	—
	S62	—	18"	62	.050"	3/8" LP	39272	1006608653	1006891528
	—	T62	18"	62	.050"	3/8" LP	—	1003903688	—
	—	J66	16"	66	.058"	.325"	—	—	—
	—	J72	18"	72	.058"	.325"	—	1001229308	—
	—	J78	20"	78	.058"	.325"	—	1004774728	—
	H66	—	16"	66	.050"	.325"	—	1004774734	—
	—	Q66	16"	66	.050"	.325"	—	—	—
	H72	—	18"	72	.050"	.325"	—	1006797688	—
	—	Q72	18"	72	.050"	.325"	—	—	—
	H78	—	20"	78	.050"	.325"	—	1006797707	—
—	Q78	20"	78	.050"	.325"	—	—	—	
—	M66 Ⓞ	16"	66	.050"	.325"	—	1006891545	—	
—	M72 Ⓞ	18"	72	.050"	.325"	—	1006891541	—	
—	M78 Ⓞ	20"	78	.050"	.325"	—	1005489217	—	
—	M80 Ⓞ	20"	80	.050"	.325"	—	1006891575	—	
234†, 238†, 242†, 246†, 340†, 340E†, 345†, 345E†, 346†, 346XP†, 350†, 350E†, 351†, 353†, 435†, 435E†, 440†, 440E†, 445†, 445E†, 450†, 543XP†, 543XPG†, 545†, 545 MARK II†, 550XP†, 550XP MARK II†, 550XPG†, 550XPG MARK II†	—	J66	16"	66	.058"	.325"	—	—	—
	—	J72	18"	72	.058"	.325"	—	1001229308	—
	—	J78	20"	78	.058"	.325"	—	1004774728	—
	—	M66 Ⓞ	16"	66	.050"	.325"	584410	1006891545	1003907264
	—	M72 Ⓞ	18"	72	.050"	.325"	584408	1006891541	1003907263
	—	M78 Ⓞ	20"	78	.050"	.325"	—	1005489217	—
—	M80 Ⓞ	20"	80	.050"	.325"	—	1006891575	—	
POLE SAW									
128LDX, 325P4, 326P4, 325P5X, 326P5X, 327P4X, 327P5X, 525P4S, 525P5, 525PT5S	S45	—	12"	45	.050"	3/8" LP	—	1006891552	—





* PRIOR TO SELECTING REPLACEMENT PARTS FOR THESE MODELS, CONSULT YOUR OWNERS MANUAL AND CHOOSE THE PARTS THAT MATCH THE FACTORY PITCH AND GAUGE SPECIFICATIONS OF YOUR SAW. BARS AND CHAINS OF DIFFERENT PITCH AND/OR GAUGE ARE OFFERED FOR YOUR SAW BUT ARE NOT CROSS-COMPATIBLE WITH EACH OTHER.

Ⓞ INDICATES NARROW KERF.
* PRIOR TO SELECTING REPLACEMENT PARTS FOR THESE MODELS, CONSULT YOUR OWNERS MANUAL AND CHOOSE THE PARTS THAT MATCH THE FACTORY PITCH AND GAUGE SPECIFICATIONS OF YOUR SAW. BARS AND CHAINS OF DIFFERENT PITCH AND/OR GAUGE ARE OFFERED FOR YOUR SAW BUT ARE NOT CROSS-COMPATIBLE WITH EACH OTHER.





Ⓞ INDICATES NARROW KERF.
* PRIOR TO SELECTING REPLACEMENT PARTS FOR THESE MODELS, CONSULT YOUR OWNERS MANUAL AND CHOOSE THE PARTS THAT MATCH THE FACTORY PITCH AND GAUGE SPECIFICATIONS OF YOUR SAW. BARS AND CHAINS OF DIFFERENT PITCH AND/OR GAUGE ARE OFFERED FOR YOUR SAW BUT ARE NOT CROSS-COMPATIBLE WITH EACH OTHER.







Ⓞ INDICATES NARROW KERF.
† THE GAUGE (WIDTH) OF THE GUILD BAR RAILS ON THESE MODELS VARY FROM THE FACTORY. TO INSURE YOUR REPLACEMENT SAW CHAIN FEEDS CORRECTLY DOWN THE RAIL OF YOUR BAR, SELECT A CHAIN WITH A MATCHING GAUGE.





JOHN DEERE	OREGON® SAW CHAIN PART NO. LOW KICKBACK	OREGON® SAW CHAIN PART NO. PRO	BAR LENGTH	DRIVE LINKS	GAUGE	PITCH	OREGON® BAR/CHAIN COMBO PART NO.	 SAW CHAIN PART NO.	 BAR/CHAIN COMBO PART NO.
25EV, 28, 28V, 30, 30V, 35EV, 40V, CS36, CS36LE, CS40, CS40LE, CS40V, J3816 ‡ CHOOSE THE REPLACEMENT PARTS IN THIS LINE ONLY IF THE ORIGINAL GUIDE BAR ON YOUR SAW HAS BEEN REPLACED WITH AN OREGON REPLACEMENT GUIDE BAR AT THIS LENGTH.	<u>S45</u>	—	12"	45	.050"	3/8" LP	<u>27792</u>	1006891552	1005490840
	<u>S52</u>		14"	52	.050"	3/8" LP	<u>27856</u>	1006797675	1006891534
		<u>T52</u>	14"	52	.050"	3/8" LP	—	1003903685	—
	<u>S56</u>		16" †	56	.050"	3/8" LP	<u>27857</u>	1006608508	1006891576
		<u>T56</u>	16" †	56	.050"	3/8" LP	—	1003903695	—
	<u>S57</u>		16"	57	.050"	3/8" LP	—	638443	—
		<u>T57</u>	16"	57	.050"	3/8" LP	—	1003903690	—
	<u>S62</u>		18"	62	.050"	3/8" LP	<u>39272</u>	1006608653	1006891528
		<u>T62</u>	18"	62	.050"	3/8" LP	—	1003903688	—
50AV, 50V, 51SV, 55SV, 55V, 60V, 65, 66SV, 70V, 80EV	<u>D60</u>		16"	60	.050"	3/8"	<u>27851</u>	1004774736	1004806822
		<u>B60, E60</u>	16"	60	.050"	3/8"	—	1003903698	—
	<u>D66</u>		18"	66	.050"	3/8"	<u>30159</u>	1001250428	1005490837
		<u>B66, E66</u>	18"	66	.050"	3/8"	—	1003903699	—
	<u>D70</u>		20"	70	.050"	3/8"	<u>27850</u>	1001229297	1003907271
		<u>B70, E70</u>	20"	70	.050"	3/8"	—	1006891572	—
	<u>D81</u>	—	24"	81	.050"	3/8"	—	1001229306	—
45EV, 46EV, 300CS, 450V	<u>H66</u>		16"	66	.050"	.325"	—	1004774734	—
		<u>Q66</u>	16"	66	.050"	.325"	—	—	—
	<u>H72</u>		18"	72	.050"	.325"	<u>36892</u>	1006797688	1003907269
		<u>Q72</u>	18"	72	.050"	.325"	—	—	—
	<u>H78</u>		20"	78	.050"	.325"	<u>37977</u>	1006797707	1006891535
	<u>Q78</u>	20"	78	.050"	.325"	—	—	—	
POLE SAW									
PS2383, PS2683, PSA10	<u>R40</u>	—	10"	40	.043"	3/8" LP	—	1006891540	—
JONSERED®									
CS16I	<u>R56</u>	—	16"	56	.043"	3/8" LP	—	1006608707	—
CS2139T, CS2236T	<u>S45</u>	—	12"	45	.050"	3/8" LP	—	1006891552	—
	<u>S52</u>		14"	52	.050"	3/8" LP	—	1006797675	—
		<u>T52</u>	14"	52	.050"	3/8" LP	—	1003903685	—
	<u>S56</u>		16"	56	.050"	3/8" LP	—	1006608508	—
		<u>T56</u>	16"	56	.050"	3/8" LP	—	1003903695	—
CS2137, CS2138	<u>S45</u>	—	12"	45	.050"	3/8" LP	<u>27792</u>	1006891552	1005490840
	<u>S52</u>		14"	52	.050"	3/8" LP	<u>27856</u>	1006797675	1006891534
		<u>T52</u>	14"	52	.050"	3/8" LP	—	1003903685	—
	<u>S56</u>		16"	56	.050"	3/8" LP	<u>27857</u>	1006608508	1006891576
		<u>T56</u>	16"	56	.050"	3/8" LP	—	1003903695	—
	<u>S62</u>		18"	62	.050"	3/8" LP	<u>39272</u>	1006608653	1006891528
		<u>T62</u>	18"	62	.050"	3/8" LP	—	1003903688	—
60, 61, 62, 66, 70, 75, 77, 80, 81, 90, 110, 111, 601, 621, 751, 801, 820, 830, 910, 920, 939, 1020	<u>D60</u>		16"	60	.050"	3/8"	<u>27853</u>	1004774736	1004806823
		<u>B60</u>	16"	60	.050"	3/8"	—	—	—
	<u>D70</u>		20"	70	.050"	3/8"	<u>27852</u>	1001229297	1004806827
		<u>B70, E70</u>	20"	70	.050"	3/8"	—	1006891572	—
	<u>P60</u>	—	16"	60	.058"	3/8"	—	—	—
520SP*, 535*, 2163*, CS2163*, CS2255*, CS2258*, CS2260* * PRIOR TO SELECTING REPLACEMENT PARTS FOR THESE MODELS, CONSULT YOUR OWNERS MANUAL AND CHOOSE THE PARTS THAT MATCH THE FACTORY PITCH AND GAUGE SPECIFICATIONS OF YOUR SAW. BARS AND CHAINS OF DIFFERENT PITCH AND/OR GAUGE ARE OFFERED FOR YOUR SAW BUT ARE NOT CROSS-COMPATIBLE WITH EACH OTHER.	<u>D60</u>		16"	60	.050"	3/8"	<u>510124</u>	1004774736	—
		<u>E60</u>	16"	60	.050"	3/8"	—	1003903698	—
	<u>D68</u>		18"	68	.050"	3/8"	<u>584271</u>	1000579263	1004806825
		<u>E68</u>	18"	68	.050"	3/8"	—	1003903697	—
	<u>D72</u>		20"	72	.050"	3/8"	—	1006608716	—
		<u>B72, E72</u>	20"	72	.050"	3/8"	—	1006891543	—
	—	<u>J64</u>	15"	64	.058"	.325"	—	1005489220	—
	—	<u>J66</u>	16"	66	.058"	.325"	—	—	—
	—	<u>J72</u>	18"	72	.058"	.325"	—	1001229308	—
45, 49, 50, 51, 52, 410, 420, 425, 435, 450, 451, 455, 510, 521, 535	—	<u>J78</u>	20"	78	.058"	.325"	—	1004774728	—
	—	<u>J64</u>	15"	64	.058"	.325"	—	1005489220	—
	—	<u>J66</u>	16"	66	.058"	.325"	—	—	—
	—	<u>J72</u>	18"	72	.058"	.325"	—	1001229308	—
CS2238*, CS2234S* Ⓞ INDICATES NARROW KERF. * PRIOR TO SELECTING REPLACEMENT PARTS FOR THESE MODELS, CONSULT YOUR OWNERS MANUAL AND CHOOSE THE PARTS THAT MATCH THE FACTORY PITCH AND GAUGE SPECIFICATIONS OF YOUR SAW. BARS AND CHAINS OF DIFFERENT PITCH AND/OR GAUGE ARE OFFERED FOR YOUR SAW BUT ARE NOT CROSS-COMPATIBLE WITH EACH OTHER.	<u>S52</u>		14"	52	.050"	3/8" LP	<u>27856</u>	1006797675	1006891534
		<u>T52</u>	14"	52	.050"	3/8" LP	—	1003903685	—
	<u>S56</u>		16"	56	.050"	3/8" LP	<u>27857</u>	1006608508	1006891576
		<u>T56</u>	16"	56	.050"	3/8" LP	—	1003903695	—
	<u>S62</u>		18"	62	.050"	3/8" LP	<u>39272</u>	1006608653	1006891528
		<u>T62</u>	18"	62	.050"	3/8" LP	—	1003903688	—
	—	<u>M66</u> Ⓞ	16"	66	.050"	.325"	—	1006891545	—
	—	<u>M72</u> Ⓞ	18"	72	.050"	.325"	—	1006891541	—
	<u>D60</u>		16"	60	.050"	3/8"	—	1004774736	—
2054*, 2055*, CS2156*, CS2159* Ⓞ INDICATES NARROW KERF. * PRIOR TO SELECTING REPLACEMENT PARTS FOR THESE MODELS, CONSULT YOUR OWNERS MANUAL AND CHOOSE THE PARTS THAT MATCH THE FACTORY PITCH AND GAUGE SPECIFICATIONS OF YOUR SAW. BARS AND CHAINS OF DIFFERENT PITCH AND/OR GAUGE ARE OFFERED FOR YOUR SAW BUT ARE NOT CROSS-COMPATIBLE WITH EACH OTHER.		<u>E60</u>	16"	60	.050"	3/8"	—	1003903698	—
	<u>D68</u>		18"	68	.050"	3/8"	—	1000579263	—
		<u>E68</u>	18"	68	.050"	3/8"	—	1003903697	—
	<u>D72</u>		20"	72	.050"	3/8"	<u>510124</u> <u>584271</u>	1006608716	— 1004806825
		<u>B72, E72</u>	20"	72	.050"	3/8"	—	1006891543	—
	—	<u>J64</u>	15"	64	.058"	.325"	—	1005489220	—
	—	<u>J66</u>	16"	66	.058"	.325"	—	—	—
	—	<u>J72</u>	18"	72	.058"	.325"	—	1001229308	—
	—	<u>M66</u> Ⓞ	16"	66	.050"	.325"	<u>584410</u>	1006891545	1003907264
2050†, 2149 TURBO†, CS2145†, CS2149†, CS2150†, CS2152†, CS2153†, CS2240†, CS2245†, CS2250†, CS2250S†, CS2252†, CS2253† Ⓞ INDICATES NARROW KERF. † THE GAUGE (WIDTH) OF THE GUID BAR RAILS ON THESE MODELS VARY FROM THE FACTORY. TO INSURE YOUR REPLACEMENT SAW CHAIN FEEDS CORRECTLY DOWN THE RAIL OF YOUR BAR, SELECT A CHAIN WITH A MATCHING GAUGE.	—	<u>M72</u> Ⓞ	18"	72	.050"	.325"	<u>584408</u>	1006891541	1003907263
	—	<u>M78</u> Ⓞ	20"	78	.050"	.325"	—	1005489217	—
	—	<u>M80</u> Ⓞ	20"	80	.050"	.325"	—	1006891575	—
	—	<u>J64</u>	15"	64	.058"	.325"	—	1005489220	—
	—	<u>J66</u>	16"	66	.058"	.325"	—	—	—
	—	<u>J72</u>	18"	72	.058"	.325"	—	1001229308	—
	—	<u>J78</u>	20"	78	.058"	.325"	—	1004774728	—
	—	<u>M66</u> Ⓞ	16"	66	.050"	.325"	<u>584410</u>	1006891545	1003907264
	—	<u>M72</u> Ⓞ	18"	72	.050"	.325"	<u>584408</u>	1006891541	1003907263

KOBALT®	OREGON® SAW CHAIN PART NO. LOW KICKBACK	OREGON® SAW CHAIN PART NO. PRO	BAR LENGTH	DRIVE LINKS	GAUGE	PITCH	OREGON® BAR/CHAIN COMBO PART NO.	 SAW CHAIN PART NO.	 BAR/CHAIN COMBO PART NO.
POLE SAW									
KPS 80-06 40V, KPS 80-07 40V, KPS 80-08 40V, 506891 40V	S33	—	8"	33	.050"	3/8" LP	—	1006891544	—
KCS 1224A-03	R45	—	12"	45	.043"	3/8" LP	27792	1006891533	1005490840
KCS 120-06 40 VOLT, 506890 40 VOLT, KCS 120-07 40 VOLT	S45	—	12"	45	.050"	3/8" LP	27792	1006891552	1005490840
KCS 4040-06	R52	—	14"	52	.043"	3/8" LP	—	1006891537	—
A011038	571037	—	18"	62	.050"	3/8" LP	—	1001468625	—
KPS 1024A-03	R34	—	8"	34	.043"	3/8" LP	—	1006891568	—
MAKITA®	OREGON® SAW CHAIN PART NO. LOW KICKBACK	OREGON® SAW CHAIN PART NO. PRO	BAR LENGTH	DRIVE LINKS	GAUGE	PITCH	OREGON® BAR/CHAIN COMBO PART NO.	 SAW CHAIN PART NO.	 BAR/CHAIN COMBO PART NO.
XCU05, XCU06	R33	—	8"	33	.043"	3/8" LP	—	1006891530	—
	R40	—	10"	40	.043"	3/8" LP	—	1006891540	—
DCS34, DCS340, DCS341, DCS400, DCS401, DCS330S, DCS3416, DCS390S, EA4300F40B, UC3050, UC3051A, UC3530A, UC3550A, UC3551A, UC4000, UC4030A, UC4050A, UC4051A, UC4550A, UC4551A	S52	—	14"	52	.050"	3/8" LP	27856	1006797675	1006891534
		T52	14"	52	.050"	3/8" LP	—	1003903685	—
	S56	—	16"	56	.050"	3/8" LP	27857	1006608508	1006891576
		T56	16"	56	.050"	3/8" LP	—	1003903695	—
5012B, 5014NB, 5016NB ‡ CHOOSE THE REPLACEMENT PARTS IN THIS LINE ONLY IF THE ORIGINAL GUIDE BAR ON YOUR SAW HAS BEEN REPLACED WITH AN OREGON REPLACEMENT GUIDE BAR AT THIS LENGTH.	S45	—	12" ‡	45	.050"	3/8" LP	27792	1006891552	1005490840
	S52	—	14"	52	.050"	3/8" LP	27856	1006797675	1006891534
		T52	14"	52	.050"	3/8" LP	—	1003903685	—
	S56	—	16"	56	.050"	3/8" LP	27857	1006608508	1006891576
		T56	16"	56	.050"	3/8" LP	—	1003903695	—
XCU03†, XCU04†, EA3200S†, EA3201S†, EA3500S†, EA3501S† † THE GAUGE (WIDTH) OF THE GUILD BAR RAILS ON THESE MODELS VARY FROM THE FACTORY. TO INSURE YOUR REPLACEMENT SAW CHAIN FEEDS CORRECTLY DOWN THE RAIL OF YOUR BAR, SELECT A CHAIN WITH A MATCHING GAUGE. ‡ CHOOSE THE REPLACEMENT PARTS IN THIS LINE ONLY IF THE ORIGINAL GUIDE BAR ON YOUR SAW HAS BEEN REPLACED WITH AN OREGON REPLACEMENT GUIDE BAR AT THIS LENGTH.	R45	—	12"	45	.043"	3/8" LP	—	1006891533	—
	R52	—	14"	52	.043"	3/8" LP	—	1006891537	—
	R56	—	16"	56	.043"	3/8" LP	623000	1006608707	1006891558
	S45	—	12" ‡	45	.050"	3/8" LP	27792	1006891552	1005490840
	S52	—	14"	52	.050"	3/8" LP	27856	1006797675	1006891534
		T52	14"	52	.050"	3/8" LP	—	1003903685	—
	S56	—	16"	56	.050"	3/8" LP	27857	1006608508	1006891576
		T56	16"	56	.050"	3/8" LP	—	1003903695	—
XCU04CM* * PRIOR TO SELECTING REPLACEMENT PARTS FOR THESE MODELS, CONSULT YOUR OWNERS MANUAL AND CHOOSE THE PARTS THAT MATCH THE FACTORY PITCH AND GAUGE SPECIFICATIONS OF YOUR SAW. BARS AND CHAINS OF DIFFERENT PITCH AND/OR GAUGE ARE OFFERED FOR YOUR SAW BUT ARE NOT CROSS-COMPATIBLE WITH EACH OTHER.	S56	—	16"	56	.050"	3/8" LP	27857	1006608508	1006891576
		T56	16"	56	.050"	3/8" LP	—	1003903695	—
	R56	—	16"	56	.043"	3/8" LP	623000	1006608707	1006891558
DCS6000I, DCS6800I	D72	—	20"	72	.050"	3/8"	510124 584271	1006608716	— 1004806825
		B72, E72	20"	72	.050"	3/8"	—	1006891543	—
DCS460*, DCS510*, DCS5121*, DCS520I*, DCS5200I*, DCS540*, EA5000P53G*, EA5600F, EA6100P53E*, EA6100P53G*, EA6101P53G* * PRIOR TO SELECTING REPLACEMENT PARTS FOR THESE MODELS, CONSULT YOUR OWNERS MANUAL AND CHOOSE THE PARTS THAT MATCH THE FACTORY PITCH AND GAUGE SPECIFICATIONS OF YOUR SAW. BARS AND CHAINS OF DIFFERENT PITCH AND/OR GAUGE ARE OFFERED FOR YOUR SAW BUT ARE NOT CROSS-COMPATIBLE WITH EACH OTHER.	D72	—	20"	72	.050"	3/8"	510124 584271	1006608716	— 1004806825
		B72, E72	20"	72	.050"	3/8"	—	1006891543	—
	H66	—	16"	66	.050"	.325"	—	1004774734	—
		Q66	16"	66	.050"	.325"	—	—	—
	H72	—	18"	72	.050"	.325"	—	1006797688	—
		Q72	18"	72	.050"	.325"	—	—	—
	H78	—	20"	78	.050"	.325"	577330	1006797707	1006680591
DCS430, DCS431		Q78	20"	78	.050"	.325"	—	—	—
	H66	—	16"	66	.050"	.325"	—	1004774734	—
		Q66	16"	66	.050"	.325"	—	—	—
	H72	—	18"	72	.050"	.325"	—	1006797688	—
		Q72	18"	72	.050"	.325"	—	—	—
	H78	—	20"	78	.050"	.325"	577330	1006797707	1006680591
DCS6400†, DCS6401†, DCS6420†, DCS6421†, DCS7300†, DCS7301†, DCS7900†, DCS7901† † THE GAUGE (WIDTH) OF THE GUILD BAR RAILS ON THESE MODELS VARY FROM THE FACTORY. TO INSURE YOUR REPLACEMENT SAW CHAIN FEEDS CORRECTLY DOWN THE RAIL OF YOUR BAR, SELECT A CHAIN WITH A MATCHING GAUGE.	D60	—	16"	60	.050"	3/8"	—	1004774736	—
		B60	16"	60	.050"	3/8"	—	—	—
	D68	—	18"	68	.050"	3/8"	—	1000579263	—
		B68	18"	68	.050"	3/8"	—	—	—
	D72	—	20"	72	.050"	3/8"	—	1006608716	—
		B72, E72	20"	72	.050"	3/8"	—	1006891543	—
	D84	—	24"	84	.050"	3/8"	—	—	—
		B84, E84	24"	84	.050"	3/8"	—	1006891539	—



PIONEER	OREGON® SAW CHAIN PART NO. LOW KICKBACK	OREGON® SAW CHAIN PART NO. PRO	BAR LENGTH	DRIVE LINKS	GAUGE	PITCH	OREGON® BAR/CHAIN COMBO PART NO.	OREGON® SAW CHAIN PART NO.	OREGON® BAR/CHAIN COMBO PART NO.
P-10, P-12	S45	–	12"	45	.050"	3/8" LP	–	1006891552	–
	S52		14"	52	.050"	3/8" LP	–	1006797675	–
		T52	14"	52	.050"	3/8" LP	–	1003903685	–
	S56		16"	56	.050"	3/8" LP	–	1006608508	–
		T56	16"	56	.050"	3/8" LP	–	1003903695	–
1074, P-21, P-26, P-28	H66		16"	66	.050"	.325"	–	1004774734	–
		Q66	16"	66	.050"	.325"	–	–	–
	H72		18"	72	.050"	.325"	–	1006797688	–
		Q72	18"	72	.050"	.325"	–	–	–
	H78		20"	78	.050"	.325"	–	1006797707	–
	Q78	20"	78	.050"	.325"	–	–	–	
970, 1072, 1073, P-11, P-20, P-25, P-285, 515	D60		16"	60	.050"	3/8"	–	1004774736	–
		B60, E60	16"	60	.050"	3/8"	–	1003903698	–
	D68		18"	68	.050"	3/8"	–	1000579263	–
		B68	18"	68	.050"	3/8"	–	–	–
	D72		20"	72	.050"	3/8"	–	1006608716	–
		B72, E72	20"	72	.050"	3/8"	–	1006891543	–
	D84		24"	84	.050"	3/8"	–	–	–
	B84	24"	84	.050"	3/8"	–	–	–	
POULAN® / POULAN PRO®	OREGON® SAW CHAIN PART NO. LOW KICKBACK	OREGON® SAW CHAIN PART NO. PRO	BAR LENGTH	DRIVE LINKS	GAUGE	PITCH	OREGON® BAR/CHAIN COMBO PART NO.	OREGON® SAW CHAIN PART NO.	OREGON® BAR/CHAIN COMBO PART NO.
PRCS16I	R56	–	16"	56	.043"	3/8" LP	–	1006608707	–
180, 190, 200, 205, 210, 220, 221, 222, 225, 235, 236, 240, 250, 255*, 260, 262, 400E, 1220, 1420, 1425, 1630, 1625, 1634, 1775, 1800, 1838, 1900, 1950, 1975, 2000, 2025, 2050, 2055, 2075, 2100, 2150, 2150 - PREDATOR, 2155, 2160, 2175, 2200, 2250, 2300, 2350, 2375, 2400, 2450, 2500, 2550, 2555, 2600, 3314, 3314WS, 3314WSA, 3316, 3416, 3516, 3516AVX, 3816, 3816AV, 3818, 4018, 4218A, 4218AVX, 4218AV, BLACKHAWK, E14E, E16E, ES 350, ES 400, MICRO 25XX, XXV SERIES, P3516PR, PATRIOT 1900, PPB3416, PPB4218, PR3816, PR4016, PR4218, S23, S25, SUPER MICRO, 25 XX, XXV SERIES, WILDTHING, WOODSHARK	S40	–	10"	40	.050"	3/8" LP	–	1006891567	–
	S45	–	12"	45	.050"	3/8" LP	27792	1006891552	1005490840
	S52		14"	52	.050"	3/8" LP	27856	1006797675	1006891534
		T52	14"	52	.050"	3/8" LP	–	1003903685	–
	S56		16"	56	.050"	3/8" LP	27857	1006608508	1006891576
		T56	16"	56	.050"	3/8" LP	–	1003903695	–
	S62		18"	62	.050"	3/8" LP	39272	1006608653	1006891528
		T62	18"	62	.050"	3/8" LP	–	1003903688	–
PL914	S52		14"	52	.050"	3/8" LP	27856	1006797675	1006891534
		T52	14"	52	.050"	3/8" LP	–	1003903685	–
PL1416	S56		16"	56	.050"	3/8" LP	27857	1006608508	1006891576
		T56	16"	56	.050"	3/8" LP	–	1003903695	–
PLN1510	S39	–	10"	39	.050"	3/8" LP	–	1003903682	–
PLN1514	S49	–	14"	49	.050"	3/8" LP	–	1003903704	–
PLN3516F	S55		16"	55	.050"	3/8" LP	–	1006891531	–
		T55	16"	55	.050"	3/8" LP	–	1003903702	–
285, 295, 305, 310, 315, 335, 336, 2700, 2750, 2775, 2800, 2900, 3000, 3050, 3100, 3300, 306SA, 4620, 4620AV, 4620AVX, PREDATOR	H66		16"	66	.050"	.325"	–	1004774734	–
		Q66	16"	66	.050"	.325"	–	–	–
	H72		18"	72	.050"	.325"	36892	1006797688	1003907269
		Q72	18"	72	.050"	.325"	–	–	–
	H78		20"	78	.050"	.325"	37977	1006797707	1006891535
	Q78	20"	78	.050"	.325"	–	–	–	
203, 245, 306, 360, 361, 375, 395, 400, 450, 3400, 3700, 3800, 3900, 4000, 4200, 4400, 4900, 5200, 5400, 5500, 6700	D60		16"	60	.050"	3/8"	27851	1004774736	1004806822
		B60, E60	16"	60	.050"	3/8"	–	1003903698	–
	D66		18"	66	.050"	3/8"	30159	1001250428	1005490837
		B66, E66	18"	66	.050"	3/8"	–	1003903699	–
	D70		20"	70	.050"	3/8"	27850	1001229297	1003907271
		B70, E70	20"	70	.050"	3/8"	–	1006891572	–
	D81	–	24"	81	.050"	3/8"	–	1001229306	–
6900, 7700, 8500	D60		16"	60	.050"	3/8"	27851	1004774736	1004806822
		B60, E60	16"	60	.050"	3/8"	–	1003903698	–
	D66		18"	66	.050"	3/8"	30159	1001250428	1005490837
		B66, E66	18"	66	.050"	3/8"	–	1003903699	–
	D70		20"	70	.050"	3/8"	27850	1001229297	1003907271
		B70, E70	20"	70	.050"	3/8"	–	1006891572	–
	D81	–	24"	81	.050"	3/8"	–	1001229306	–
415, 425, 445, 475, 505	D60		16"	60	.050"	3/8"	27851	1004774736	1004806822
		B60, E60	16"	60	.050"	3/8"	–	1003903698	–
	D66		18"	66	.050"	3/8"	30159	1001250428	1005490837
		B66, E66	18"	66	.050"	3/8"	–	1003903699	–
	D70		20"	70	.050"	3/8"	27850	1001229297	1003907271
		B70, E70	20"	70	.050"	3/8"	–	1006891572	–
	D81	–	24"	81	.050"	3/8"	–	1001229306	–
PP4818AVX	D66		18"	66	.050"	3/8"	30159	1001250428	1005490837
		B66, E66	18"	66	.050"	3/8"	–	1003903699	–
PP5020AV, PR5020 ‡ CHOOSE THE REPLACEMENT PARTS IN THIS LINE ONLY IF THE ORIGINAL GUIDE BAR ON YOUR SAW HAS BEEN REPLACED WITH AN OREGON REPLACEMENT GUIDE BAR AT THIS LENGTH.	D70		20"	70	.050"	3/8"	–	1001229297	–
		B70, E70	20"	70	.050"	3/8"	–	1006891572	–
	D72		20" ‡	72	.050"	3/8"	584271	1006608716	1004806825
		B72, E72	20" ‡	72	.050"	3/8"	–	1006891543	–
ES300, ES350	R56	–	16"	56	.043"	3/8" LP	–	1006608707	–
POLE SAW									
446T, PRO 445, PRO 446, PP258TP, PP258TPC, PP338PT, PP5000P	R34	–	8"	34	.043"	3/8" LP	–	1006891568	–
PPB40PS	S33	–	8"	33	.050"	3/8" LP	–	1006891544	–



POWERHORSE	OREGON® SAW CHAIN PART NO. LOW KICKBACK	OREGON® SAW CHAIN PART NO. PRO	BAR LENGTH	DRIVE LINKS	GAUGE	PITCH	OREGON® BAR/CHAIN COMBO PART NO.	 SAW CHAIN PART NO.	 BAR/CHAIN COMBO PART NO.
190500, 190501, 190555	<u>S52</u>		14"	52	.050"	3/8" LP	<u>27856</u>	1006797675	1006891534
		<u>T52</u>	14"	52	.050"	3/8" LP	—	1003903685	—
	<u>S56</u>		16"	56	.050"	3/8" LP	<u>27857</u>	1006608508	1006891576
		<u>T56</u>	16"	56	.050"	3/8" LP	—	1003903695	—
190556, 190558	<u>S57</u>		16"	57	.050"	3/8" LP	—	638443	—
		<u>T57</u>	16"	57	.050"	3/8" LP	—	1003903690	—
190502†, 190503†, 190557†, 190559† <small>† THE GAUGE (WIDTH) OF THE GUILD BAR RAILS ON THESE MODELS VARY FROM THE FACTORY. TO INSURE YOUR REPLACEMENT SAW CHAIN FEEDS CORRECTLY DOWN THE RAIL OF YOUR BAR, SELECT A CHAIN WITH A MATCHING GAUGE.</small>	<u>H72</u>		18"	72	.050"	.325"	—	1006797688	—
		<u>Q72</u>	18"	72	.050"	.325"	—	—	—
	<u>H78</u>		20"	78	.050"	.325"	—	1006797707	—
		<u>Q78</u>	20"	78	.050"	.325"	—	—	—
	—	<u>J72</u>	18"	72	.058"	.325"	—	1001229308	—
	—	<u>J78</u>	20"	78	.058"	.325"	—	1004774728	—
REDMAX®	OREGON® SAW CHAIN PART NO. LOW KICKBACK	OREGON® SAW CHAIN PART NO. PRO	BAR LENGTH	DRIVE LINKS	GAUGE	PITCH	OREGON® BAR/CHAIN COMBO PART NO.	 SAW CHAIN PART NO.	 BAR/CHAIN COMBO PART NO.
G250, G300AVS, G300TS, G2500, G2500TS, G3100TS, G3200EZ, G3300EZ, G3800, G3800AVS, GZ380, GZ400, GZ3500T, GZ4000	<u>S45</u>	—	12"	45	.050"	3/8" LP	<u>27792</u>	1006891552	1005490840
	<u>S52</u>		14"	52	.050"	3/8" LP	<u>27856</u>	1006797675	1006891534
		<u>T52</u>	14"	52	.050"	3/8" LP	—	1003903685	—
	<u>S56</u>		16"	56	.050"	3/8" LP	<u>27857</u>	1006608508	1006891576
		<u>T56</u>	16"	56	.050"	3/8" LP	—	1003903695	—
	<u>S62</u>		18"	62	.050"	3/8" LP	<u>39272</u>	1006608653	1006891528
	<u>T62</u>	18"	62	.050"	3/8" LP	—	1003903688	—	
G621AVS	<u>D60</u>		16"	60	.050"	3/8"	—	1004774736	—
		<u>B60, E60</u>	16"	60	.050"	3/8"	—	1003903698	—
	<u>D66</u>		18"	66	.050"	3/8"	—	1001250428	—
		<u>B66, E66</u>	18"	66	.050"	3/8"	—	1003903699	—
	<u>D70</u>		20"	70	.050"	3/8"	—	1001229297	—
		<u>B70, E70</u>	20"	70	.050"	3/8"	—	1006891572	—
GZ7000, GZ7100, G9000	<u>D68</u>		18"	68	.050"	3/8"	—	1000579263	—
		<u>B68</u>	18"	68	.050"	3/8"	—	—	—
	<u>D72</u>		20"	72	.050"	3/8"	—	1006608716	—
		<u>B72</u>	20"	72	.050"	3/8"	—	—	—
	<u>D84</u>		24"	84	.050"	3/8"	—	—	—
		<u>B84</u>	24"	84	.050"	3/8"	—	—	—
PSZ2465S	<u>S44</u>		12"	44	.050"	3/8" LP	—	1003903684	—
		<u>T44</u>	12"	44	.050"	3/8" LP	—	—	—
G390, G450AVS, G455AVS, G530, G5000, G5000AVS, GZ550 <small>Ⓢ INDICATES NARROW KERF.</small>	—	<u>J56</u>	13"	56	.058"	.325"	—	—	—
	—	<u>J64</u>	15"	64	.058"	.325"	—	1005489220	—
	—	<u>J66</u>	16"	66	.058"	.325"	—	—	—
	—	<u>J72</u>	18"	72	.058"	.325"	—	1001229308	—
	—	<u>J78</u>	20"	78	.058"	.325"	—	1004774728	—
	<u>H66</u>		16"	66	.050"	.325"	—	1004774734	—
		<u>Q66</u>	16"	66	.050"	.325"	—	—	—
	<u>H72</u>		18"	72	.050"	.325"	—	1006797688	—
		<u>Q72</u>	18"	72	.050"	.325"	—	—	—
	<u>H78</u>		20"	78	.050"	.325"	—	1006797707	—
		<u>Q78</u>	20"	78	.050"	.325"	—	—	—
	—	<u>M66</u> Ⓢ	16"	66	.050"	.325"	<u>584410</u>	1006891545	1003907264
	—	<u>M72</u> Ⓢ	18"	72	.050"	.325"	<u>584408</u>	1006891541	1003907263
	—	<u>M78</u> Ⓢ	20"	78	.050"	.325"	—	1005489217	—
GZ4500 <small>Ⓢ INDICATES NARROW KERF.</small>	—	<u>M66</u> Ⓢ	16"	66	.050"	.325"	—	1006891545	—
	—	<u>M72</u> Ⓢ	18"	72	.050"	.325"	—	1006891541	—
POLE SAW									
PSZ2401, PSZ2450S, PSZ2460S	<u>R44</u>	—	12"	44	.043"	3/8" LP	—	1003903692	—
PRO GZ25N, PSZ2500S	<u>R44</u>	—	12"	44	.043"	3/8" LP	—	1003903692	—



REMINGTON®	OREGON® SAW CHAIN PART NO. LOW KICKBACK	OREGON® SAW CHAIN PART NO. PRO	BAR LENGTH	DRIVE LINKS	GAUGE	PITCH	OREGON® BAR/CHAIN COMBO PART NO.	 SAW CHAIN PART NO.	 BAR/CHAIN COMBO PART NO.
ES1512US, RM1215	S45	—	12"	45	.050"	3/8" LP	—	1006891552	—
M15012US	S48	—	12"	48	.050"	3/8" LP	—	1004774731	—
M15014AS, M15014US	S52		14"	52	.050"	3/8" LP	—	1006797675	—
		T52	14"	52	.050"	3/8" LP	—	1003903685	—
100089-06A, ES1514US, RM1415A, RM1415U, RM1425	S50		14"	50	.050"	3/8" LP	—	1006891547	—
		T50	14"	50	.050"	3/8" LP	—	1003903703	—
RM4214	S53	—	14"	53	.050"	3/8" LP	—	1003903706	—
107624-01, 107624-02, 107625-01, 107625-02, 111174-01, CLD3516AWB, CLD4016W, LD3516AWB, LD4016AW, RM1632A, RM1635W, RM1640W, RM1645	S56		16"	56	.050"	3/8" LP	—	1006608508	—
		T56	16"	56	.050"	3/8" LP	—	1003903695	—
M30016AS, M30016AS-1, M30016US, M35016AS, M35016AW, RM1630A, RM1630U, RM1630W	S58	—	16"	58	.050"	3/8" LP	—	1001101850	—
RM4216	S57		16"	57	.050"	3/8" LP	—	638443	—
		T57	16"	57	.050"	3/8" LP	—	1003903690	—
111174-01, CLD4018AW, CLD4018AWC, LD4018AW, LD4018WC, RM1840W	S62		18"	62	.050"	3/8" LP	—	1006608653	—
		T62	18"	62	.050"	3/8" LP	—	1003903688	—
RM4218	S62		18"	62	.050"	3/8" LP	—	1006608653	—
		T62	18"	62	.050"	3/8" LP	—	1003903688	—
RM4618, RM5118	H72		18"	72	.050"	.325"	—	1006797688	—
		Q72	18"	72	.050"	.325"	—	—	—
RM4620, RM5520	H78		20"	78	.050"	.325"	—	1006797707	—
		Q78	20"	78	.050"	.325"	—	—	—
RM0818B	R34	—	8"	34	.043"	3/8" LP	—	1006891568	—
POLE SAW									
106821A WIZARD, 106890-01, 106890-02, PS1510A, RM1015SP, RM1025P, RM1025SPS, RM1035P	S40	—	10"	40	.050"	3/8" LP	—	1006891567	—
RM4050, RM4050B	S33	—	8"	33	.050"	3/8" LP	—	1006891544	—
11409-01 BRANCH WIZARD, RM0612P	R28	—	6"	28	.043"	3/8" LP	—	1004774733	—
104317, RM0815P, RM0818BPS	R34	—	8"	34	.043"	3/8" LP	—	1006891568	—
RM2599	R34	—	8"	34	.043"	3/8" LP	—	1006891568	—
RYOBI®	OREGON® SAW CHAIN PART NO. LOW KICKBACK	OREGON® SAW CHAIN PART NO. PRO	BAR LENGTH	DRIVE LINKS	GAUGE	PITCH	OREGON® BAR/CHAIN COMBO PART NO.	 SAW CHAIN PART NO.	 BAR/CHAIN COMBO PART NO.
RY5020, RY10518, RY10519, RY10520, RY10521	H72		18"	72	.050"	.325"	36892	1006797688	1003907269
		Q72	18"	72	.050"	.325"	—	—	—
	H78		20"	78	.050"	.325"	37977	1006797707	1006891535
		Q78	20"	78	.050"	.325"	—	—	—
RY3714, RY40530, RY40503	S52		14"	52	.050"	3/8" LP	27856	1006797675	1006891534
		T52	14"	52	.050"	3/8" LP	—	1003903685	—
RY3716	S56		16"	56	.050"	3/8" LP	27857	1006608508	1006891576
		T56	16"	56	.050"	3/8" LP	—	1003903695	—
RY3818, RY10532, ZRRY10532	S62		18"	62	.050"	3/8" LP	—	1006608653	—
		T62	18"	62	.050"	3/8" LP	—	1003903688	—
P4360, RY43160, P4361	R33	—	8"	33	.043"	3/8" LP	—	1006891530	—
P540, P540A, P540B, P542, P543, P545, P547, RY52003, RY52003A, TP30 CS1800 18 VOLT CORDLESS	R40	—	10"	40	.043"	3/8" LP	—	1006891540	—
RY40500, RY40510B	R45	—	12"	45	.043"	3/8" LP	—	1006891533	—
RY40502, RY40511	R52	—	14"	52	.043"	3/8" LP	—	1006891537	—
POLE SAW									
PP720R, P542	R34	—	8"	34	.043"	3/8" LP	—	1006891568	—
	R40	—	10"	40	.043"	3/8" LP	—	1006891540	—
SENIX	OREGON® SAW CHAIN PART NO. LOW KICKBACK	OREGON® SAW CHAIN PART NO. PRO	BAR LENGTH	DRIVE LINKS	GAUGE	PITCH	OREGON® BAR/CHAIN COMBO PART NO.	 SAW CHAIN PART NO.	 BAR/CHAIN COMBO PART NO.
CS4QL-L1	S62		18"	62	.050"	3/8" LP	—	1006608653	—
		T62	18"	62	.050"	3/8" LP	—	1003903688	—



SHINDAIWA®			OREGON® SAW CHAIN PART NO. LOW KICKBACK	OREGON® SAW CHAIN PART NO. PRO	BAR LENGTH	DRIVE LINKS	GAUGE	PITCH	OREGON® BAR/CHAIN COMBO PART NO.	 SAW CHAIN PART NO.	 BAR/CHAIN COMBO PART NO.
90, 100, 110, 120, 140, 150, 326T	<u>S40</u>	—	10"	40	.050"	3/8" LP	—	1006891567	—		
	<u>S45</u>	—	12"	45	.050"	3/8" LP	<u>27792</u>	1006891552	1005490840		
	<u>S52</u>		14"	52	.050"	3/8" LP	<u>27856</u>	1006797675	1006891534		
		<u>T52</u>		14"	52	.050"	3/8" LP	—	1003903685	—	
	<u>S57</u>		16"	57	.050"	3/8" LP	—	638443	—		
		<u>T57</u>		16"	57	.050"	3/8" LP	—	1003903690	—	
350, 352S, 357	<u>S53</u>	—	14"	53	.050"	3/8" LP	—	1003903706	—		
	<u>S57</u>		16"	57	.050"	3/8" LP	—	638443	—		
		<u>T57</u>		16"	57	.050"	3/8" LP	—	1003903690	—	
488, 500, 502S	<u>H66</u>		16"	66	.050"	.325"	—	1004774734	—		
		<u>Q66</u>	16"	66	.050"	.325"	—	—	—		
	<u>H72</u>		18"	72	.050"	.325"	<u>36892</u>	1006797688	1003907269		
		<u>Q72</u>	18"	72	.050"	.325"	—	—	—		
	<u>H78</u>		20"	78	.050"	.325"	<u>37977</u>	1006797707	1006891535		
	<u>Q78</u>	20"	78	.050"	.325"	—	—	—			
305S	<u>S52</u>		14"	52	.050"	3/8" LP	<u>27856</u>	1006797675	1006891534		
		<u>T52</u>	14"	52	.050"	3/8" LP	—	1003903685	—		
340S	<u>S57</u>		16"	57	.050"	3/8" LP	—	638443	—		
		<u>T57</u>	16"	57	.050"	3/8" LP	—	1003903690	—		
358TS	<u>S52</u>		14"	52	.050"	3/8" LP	<u>27856</u>	1006797675	1006891534		
		<u>T52</u>	14"	52	.050"	3/8" LP	—	1003903685	—		
	<u>S57</u>		16"	57	.050"	3/8" LP	—	638443	—		
		<u>T57</u>	16"	57	.050"	3/8" LP	—	1003903690	—		
402S	<u>S62</u>		18"	62	.050"	3/8" LP	<u>39272</u>	1006608653	1006891528		
		<u>T62</u>	18"	62	.050"	3/8" LP	—	1003903688	—		
550, 575, 577, 680*, 695*, 757*, 757C*, 757W*	<u>D60</u>		16"	60	.050"	3/8"	—	1004774736	—		
		<u>B60</u>	16"	60	.050"	3/8"	—	—	—		
	<u>D66</u>		18"	66	.050"	3/8"	—	1001250428	—		
		<u>B66</u>	18"	66	.050"	3/8"	—	—	—		
	<u>D72</u>		20"	72	.050"	3/8"	—	1006608716	—		
		<u>B72</u>	20"	72	.050"	3/8"	—	—	—		
	<u>D84</u>		24"	84	.050"	3/8"	—	—	—		
	<u>B84</u>	24"	84	.050"	3/8"	—	—	—			
491S	<u>H72</u>		18"	72	.050"	.325"	—	1006797688	—		
		<u>Q72</u>	18"	72	.050"	.325"	—	—	—		
	<u>H78</u>		20"	78	.050"	.325"	—	1006797707	—		
		<u>Q78</u>	20"	78	.050"	.325"	—	—	—		
591	<u>D70</u>		20"	70	.050"	3/8"	<u>27850</u>	1001229297	1003907271		
		<u>B70, E70</u>	20"	70	.050"	3/8"	—	1006891572	—		
600SX	<u>D70</u>		20"	70	.050"	3/8"	<u>27850</u>	1001229297	1003907271		
		<u>B70, E70</u>	20"	70	.050"	3/8"	—	1006891572	—		
	<u>D81</u>	—	24"	81	.050"	3/8"	—	1001229306	—		
SKIL®			OREGON® SAW CHAIN PART NO. LOW KICKBACK	OREGON® SAW CHAIN PART NO. PRO	BAR LENGTH	DRIVE LINKS	GAUGE	PITCH	OREGON® BAR/CHAIN COMBO PART NO.	 SAW CHAIN PART NO.	 BAR/CHAIN COMBO PART NO.
1600, 1601, 1602, 1610, 1611, 1612, 1613, 1614, 1616, 1700, 1705, 1712	<u>S40</u>	—	10"	40	.050"	3/8" LP	—	1006891567	—		
	<u>S45</u>	—	12"	45	.050"	3/8" LP	—	1006891552	—		
	<u>S52</u>		14"	52	.050"	3/8" LP	—	1006797675	—		
		<u>T52</u>		14"	52	.050"	3/8" LP	—	1003903685	—	
	<u>S56</u>		16"	56	.050"	3/8" LP	—	1006608508	—		
		<u>T56</u>		16"	56	.050"	3/8" LP	—	1003903695	—	
1620, 1622, 1624, 1634, 1635, 1636	<u>S40</u>	—	10"	40	.050"	3/8" LP	—	1006891567	—		
	<u>S45</u>	—	12"	45	.050"	3/8" LP	<u>27792</u>	1006891552	1005490840		
	<u>S52</u>		14"	52	.050"	3/8" LP	<u>27856</u>	1006797675	1006891534		
		<u>T52</u>		14"	52	.050"	3/8" LP	—	1003903685	—	
	<u>S56</u>		16"	56	.050"	3/8" LP	<u>27857</u>	1006608508	1006891576		
		<u>T56</u>		16"	56	.050"	3/8" LP	—	1003903695	—	
	<u>S62</u>		18"	62	.050"	3/8" LP	<u>39272</u>	1006608653	1006891528		
	<u>T62</u>		18"	62	.050"	3/8" LP	—	1003903688	—		
605, 606	<u>S52</u>		14"	52	.050"	3/8" LP	—	1006797675	—		
		<u>T52</u>	14"	52	.050"	3/8" LP	—	1003903685	—		
	<u>S58</u>	—	16"	58	.050"	3/8" LP	—	1001101850	—		
CS4555-10	<u>R52</u>	—	14"	52	.043"	3/8" LP	—	1006891537	—		
1641	<u>D60</u>		16"	60	.050"	3/8"	<u>27851</u>	1004774736	1004806822		
		<u>B60, E60</u>	16"	60	.050"	3/8"	—	1003903698	—		
	<u>D66</u>		18"	66	.050"	3/8"	<u>30159</u>	1001250428	1005490837		
		<u>B66, E66</u>	18"	66	.050"	3/8"	—	1003903699	—		
	<u>D70</u>		20"	70	.050"	3/8"	<u>27850</u>	1001229297	1003907271		
		<u>B70, E70</u>	20"	70	.050"	3/8"	—	1006891572	—		
	<u>D81</u>	—	24"	81	.050"	3/8"	—	1001229306	—		



* PRIOR TO SELECTING REPLACEMENT PARTS FOR THESE MODELS, CONSULT YOUR OWNERS MANUAL AND CHOOSE THE PARTS THAT MATCH THE FACTORY PITCH AND GAUGE SPECIFICATIONS OF YOUR SAW. BARS AND CHAINS OF DIFFERENT PITCH AND/OR GAUGE ARE OFFERED FOR YOUR SAW BUT ARE NOT CROSS-COMPATIBLE WITH EACH OTHER.

SUN JOE®	OREGON® SAW CHAIN PART NO. LOW KICKBACK	OREGON® SAW CHAIN PART NO. PRO	BAR LENGTH	DRIVE LINKS	GAUGE	PITCH	OREGON® BAR/CHAIN COMBO PART NO.	 SAW CHAIN PART NO.	 BAR/CHAIN COMBO PART NO.
SWJ800E, SWJ802E, ION8PS, SWJ806E	S33	—	8"	33	.050"	3/8" LP	—	1006891544	—
SWJ803E	S40	—	10"	40	.050"	3/8" LP	—	1006891567	—
20VION-CS10	S40	—	10"	40	.050"	3/8" LP	—	1006891567	—
SWJ698E	S45	—	12"	45	.050"	3/8" LP	—	1006891552	—
SWJ699E	S52	—	14"	52	.050"	3/8" LP	27856	1006797675	1006891534
	—	T52	14"	52	.050"	3/8" LP	—	1003903685	—
ION16CS	S56	—	16"	56	.050"	3/8" LP	27857	1006608508	1006891576
	—	T56	16"	56	.050"	3/8" LP	—	1003903695	—
SWJ700E	S57	—	16"	57	.050"	3/8" LP	—	638443	—
	—	T57	16"	57	.050"	3/8" LP	—	1003903690	—
SWJ701E	S62	—	18"	62	.050"	3/8" LP	39272	1006608653	1006891528
	—	T62	18"	62	.050"	3/8" LP	—	1003903688	—
TANAKA®									
TCS33EDTP12, TCS33EDTP14	S45	—	12"	45	.050"	3/8" LP	27792	1006891552	1005490840
	S52	—	14"	52	.050"	3/8" LP	27856	1006797675	1006891534
	—	T52	14"	52	.050"	3/8" LP	—	1003903685	—
TCS3301PFS, TCS33EB, TCS3351PFS, TCS3401	S45	—	12"	45	.050"	3/8" LP	27792	1006891552	1005490840
	S52	—	14"	52	.050"	3/8" LP	27856	1006797675	1006891534
	—	T52	14"	52	.050"	3/8" LP	—	1003903685	—
	S57	—	16"	57	.050"	3/8" LP	—	638443	—
	—	T57	16"	57	.050"	3/8" LP	—	1003903690	—
	S62	—	18"	62	.050"	3/8" LP	—	1006608653	—
—	T62	18"	62	.050"	3/8" LP	—	1003903688	—	
ECV4501, ECS-4000, ECS-4000B	H66	—	16"	66	.050"	.325"	—	1004774734	—
	—	Q66	16"	66	.050"	.325"	—	—	—
	H72	—	18"	72	.050"	.325"	—	1006797688	—
	—	Q72	18"	72	.050"	.325"	—	—	—
	H78	—	20"	78	.050"	.325"	37977	1006797707	1006891535
—	Q78	20"	78	.050"	.325"	—	—	—	
TCS51EAP <small>Ⓢ INDICATES NARROW KERF.</small>	—	M66 Ⓢ	16"	66	.050"	.325"	—	1006891545	—
	—	M72 Ⓢ	18"	72	.050"	.325"	—	1006891541	—
	H78	—	20"	78	.050"	.325"	37977	1006797707	1006891535
	—	Q78	20"	78	.050"	.325"	—	—	—
TCS40EA <small>Ⓢ INDICATES NARROW KERF.</small>	—	M66 Ⓢ	16"	66	.050"	.325"	—	1006891545	—
	—	M72 Ⓢ	18"	72	.050"	.325"	—	1006891541	—
ECV5601	H66	—	16"	66	.050"	.325"	—	1004774734	—
	—	Q66	16"	66	.050"	.325"	—	—	—
	H72	—	18"	72	.050"	.325"	—	1006797688	—
	—	Q72	18"	72	.050"	.325"	—	—	—
	H78	—	20"	78	.050"	.325"	577330	1006797707	1006680591
—	Q78	20"	78	.050"	.325"	—	—	—	
TORO®									
51100, 51140	S40	—	10"	40	.050"	3/8" LP	—	1006891567	—
	S45	—	12"	45	.050"	3/8" LP	27792	1006891552	1005490840
	S52	—	14"	52	.050"	3/8" LP	27856	1006797675	1006891534
	—	T52	14"	52	.050"	3/8" LP	—	1003903685	—
	S56	—	16"	56	.050"	3/8" LP	—	1006608508	—
	—	T56	16"	56	.050"	3/8" LP	—	1003903695	—
51850	R56	—	16"	56	.043"	3/8" LP	—	1006608707	—
TROY-BILT®									
TB4016, TB4216, TB4218	S54	—	16"	54	.050"	3/8" LP	509535	1003903705	1004806824
	S60	—	18"	60	.050"	3/8" LP	509536	1005489219	—
TB4018	S52	—	14"	52	.050"	3/8" LP	27856	1006797675	1006891534
	—	T52	14"	52	.050"	3/8" LP	—	1003903685	—
	S56	—	16"	56	.050"	3/8" LP	27857	1006608508	1006891576
	—	T56	16"	56	.050"	3/8" LP	—	1003903695	—
	S62	—	18"	62	.050"	3/8" LP	39272	1006608653	1006891528
	—	T62	18"	62	.050"	3/8" LP	—	1003903688	—
TB3516 ELECTRIC, TB4516 ELECTRIC	S55	—	16"	55	.050"	3/8" LP	—	1006891531	—
	—	T55	16"	55	.050"	3/8" LP	—	1003903702	—
TB4620, TB4920, TB5018, TB5020, TB5518 <small>Ⓢ INDICATES NARROW KERF.</small>	H66	—	16"	66	.050"	.325"	—	1004774734	—
	—	Q66	16"	66	.050"	.325"	—	—	—
	H72	—	18"	72	.050"	.325"	—	1006797688	—
	—	Q72	18"	72	.050"	.325"	—	—	—
	H78	—	20"	78	.050"	.325"	—	1006797707	—
	—	Q78	20"	78	.050"	.325"	—	—	—
	—	M66 Ⓢ	16"	66	.050"	.325"	584410	1006891545	1003907264
	—	M72 Ⓢ	18"	72	.050"	.325"	584408	1006891541	1003907263
—	M78 Ⓢ	20"	78	.050"	.325"	—	1005489217	—	
POLE SAW									
TBPS	S34	—	8"	34	.050"	3/8" LP	—	1003903683	—
TBPS-8 DL	R34	—	8"	34	.043"	3/8" LP	—	1006891568	—

WEN / WAGNER	OREGON® SAW CHAIN PART NO. LOW KICKBACK	OREGON® SAW CHAIN PART NO. PRO	BAR LENGTH	DRIVE LINKS	GAUGE	PITCH	OREGON® BAR/CHAIN COMBO PART NO.	 SAW CHAIN PART NO.	 BAR/CHAIN COMBO PART NO.
4019	<u>S33</u>	—	8"	33	.050"	3/8" LP	—	1006891544	—
1100 (TYPE 1), 1200 (TYPE 1), 1400 (TYPE 1)	<u>S49</u>	—	12"	48	.050"	3/8" LP	—	1003903704	—
	<u>S54</u>	—	14"	54	.050"	3/8" LP	—	1003903705	—
3814, 4014	<u>S52</u>	—	14"	52	.050"	3/8" LP	<u>27856</u>	1006797675	1006891534
	—	<u>T52</u>	14"	52	.050"	3/8" LP	—	1003903685	—
	<u>S56</u>	—	16"	56	.050"	3/8" LP	<u>27857</u>	1006608508	1006891576
	—	<u>T56</u>	16"	56	.050"	3/8" LP	—	1003903695	—
1100, 1200, 1400, 2000, 2400, 2600, 2700, 5000, 5008, 5010, 5014, 5016, BUMBLE BEE, HORNET, WASP	<u>S49</u>	—	12"	49	.050"	3/8" LP	—	1003903704	—
	<u>S53</u>	—	14"	53	.050"	3/8" LP	—	1003903706	—
	<u>S58</u>	—	16"	58	.050"	3/8" LP	—	1001101850	—
6014, 6016, LUMBERJACK	<u>S49</u>	—	14"	49	.050"	3/8" LP	—	1003903704	—
	<u>S55</u>	—	16"	55	.050"	3/8" LP	—	1006891531	—
	—	<u>T55</u>	16"	55	.050"	3/8" LP	—	1003903702	—
3816, 3818, 4016	<u>S54</u>	—	16"	54	.050"	3/8" LP	<u>509535</u>	1003903705	1004806824
	<u>S60</u>	—	18"	60	.050"	3/8" LP	<u>509536</u>	1005489219	—

WESTERN AUTO	OREGON® SAW CHAIN PART NO. LOW KICKBACK	OREGON® SAW CHAIN PART NO. PRO	BAR LENGTH	DRIVE LINKS	GAUGE	PITCH	OREGON® BAR/CHAIN COMBO PART NO.	 SAW CHAIN PART NO.	 BAR/CHAIN COMBO PART NO.
1800, 2000, 525 DA, AV14, AV16, CAT 17, WIZ:010, WIZ:012, WIZ:014, WIZ:110, WIZ:112, WIZ:212, WIZ:214, WIZ:316	<u>S40</u>	—	10"	40	.050"	3/8" LP	—	1006891567	—
	<u>S45</u>	—	12"	45	.050"	3/8" LP	<u>27792</u>	1006891552	1005490840
	<u>S52</u>	—	14"	52	.050"	3/8" LP	<u>27856</u>	1006797675	1006891534
	—	<u>T52</u>	14"	52	.050"	3/8" LP	—	1003903685	—
	<u>S57</u>	—	16"	57	.050"	3/8" LP	—	638443	—
	—	<u>T57</u>	16"	57	.050"	3/8" LP	—	1003903690	—
3400, 430, B013, WIZARD AV18	<u>D60</u>	—	16"	60	.050"	3/8"	<u>27851</u>	1004774736	1004806822
	—	<u>B60, E60</u>	16"	60	.050"	3/8"	—	1003903698	—
	<u>D66</u>	—	18"	66	.050"	3/8"	<u>30159</u>	1001250428	1005490837
	—	<u>B66, E66</u>	18"	66	.050"	3/8"	—	1003903699	—
	<u>D70</u>	—	20"	70	.050"	3/8"	<u>27850</u>	1001229297	1003907271
	—	<u>B70, E70</u>	20"	70	.050"	3/8"	—	1006891572	—

WORX®	OREGON® SAW CHAIN PART NO. LOW KICKBACK	OREGON® SAW CHAIN PART NO. PRO	BAR LENGTH	DRIVE LINKS	GAUGE	PITCH	OREGON® BAR/CHAIN COMBO PART NO.	 SAW CHAIN PART NO.	 BAR/CHAIN COMBO PART NO.
WG300, WG303, WG303.1, WG304, WG304.1	<u>S53</u>	—	14"	53	.050"	3/8" LP	—	1003903706	—
	<u>S57</u>	—	16"	57	.050"	3/8" LP	—	638443	—
	—	<u>T57</u>	16"	57	.050"	3/8" LP	—	1003903690	—
	<u>S63</u>	—	18"	63	.050"	3/8" LP	—	1001229379	—
WG309	<u>S40</u>	—	10"	40	.050"	3/8" LP	—	1006891567	—
WG310	<u>S34</u>	—	8"	34	.050"	3/8" LP	—	1003903683	—
WG305, WG305.1	<u>S52</u>	—	14"	52	.050"	3/8" LP	<u>27856</u>	1006797675	1006891534
	—	<u>T52</u>	14"	52	.050"	3/8" LP	—	1003903685	—
WG307 JAWSAW, WG308 JAWSAW POLE SAW, WG320 JAWSAW, WG321 JAWSAW	—	<u>A42</u>	6"	42	.050"	1/4"	—	1005489218	—

YARDWORKS	OREGON® SAW CHAIN PART NO. LOW KICKBACK	OREGON® SAW CHAIN PART NO. PRO	BAR LENGTH	DRIVE LINKS	GAUGE	PITCH	OREGON® BAR/CHAIN COMBO PART NO.	 SAW CHAIN PART NO.	 BAR/CHAIN COMBO PART NO.
7.5A ELECTRIC CHAINSAW AND POLE SAW	<u>S40</u>	—	10"	40	.050"	3/8" LP	—	1006891567	—
9A ELECTRIC, 10A ELECTRIC, 11A ELECTRIC	<u>S52</u>	—	14"	52	.050"	3/8" LP	<u>27856</u>	1006797675	1006891534
	—	<u>T52</u>	14"	52	.050"	3/8" LP	—	1003903685	—
	<u>S57</u>	—	16"	57	.050"	3/8" LP	—	638443	—
	—	<u>T57</u>	16"	57	.050"	3/8" LP	—	1003903690	—
	<u>S62</u>	—	18"	62	.050"	3/8" LP	<u>39272</u>	1006608653	1006891528
	—	<u>T62</u>	18"	62	.050"	3/8" LP	—	1003903688	—
12A ELECTRIC	<u>S57</u>	—	16"	57	.050"	3/8" LP	—	638443	—
	—	<u>T57</u>	16"	57	.050"	3/8" LP	—	1003903690	—
13A ELECTRIC	<u>S62</u>	—	18"	62	.050"	3/8" LP	<u>39272</u>	1006608653	1006891528
	—	<u>T62</u>	18"	62	.050"	3/8" LP	—	1003903688	—