



attention:

Hole position schematic diagram

-  Screw holes for installing sofa legs.
-  Screw holes for installing support rods.
-  Screw holes for installing connector.

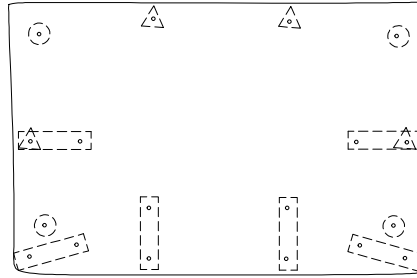

Installation 127-2

step1

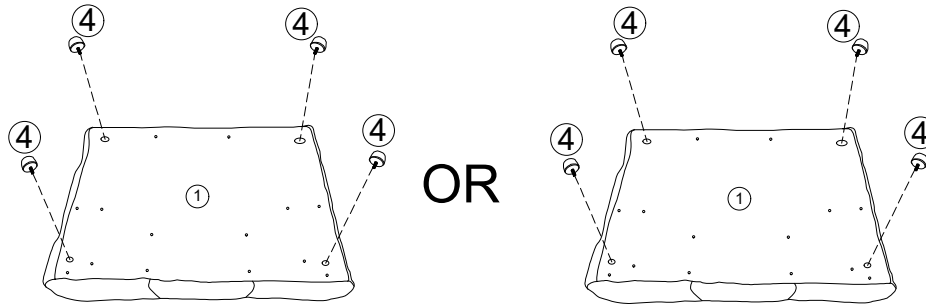

To avoid scratches and swallowing parts, please do not install by children!

step2



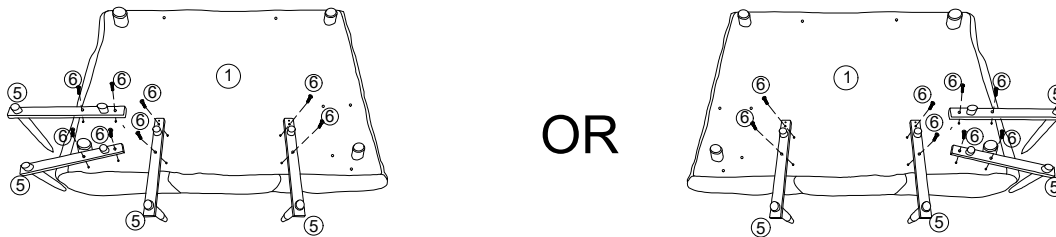



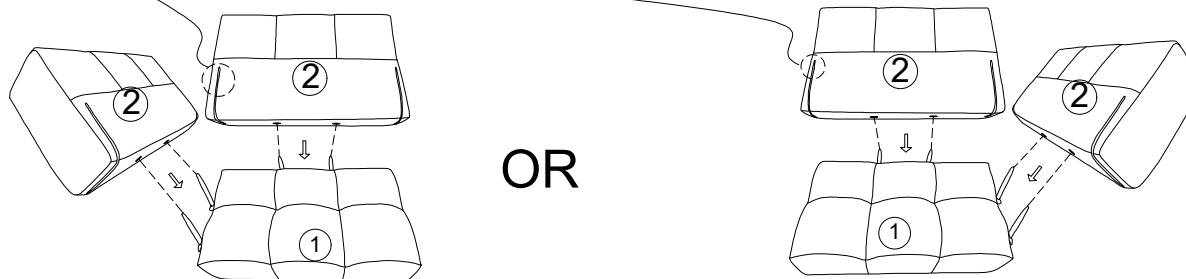

Installation sofa legs and support rods. The side support rods can be installed on the left or on the right.



step3

Pay attention to the direction of one end of the zipper, inward.



| NO | Image | Parts Name | Size | Qty |
|----|---|---------------------|------|------|
| ① |  | Seat | | 1pcs |
| ② |  | Backrest/Armrest | | 2pcs |
| ③ |  | Back cushion | | 1pcs |
| ④ |  | Legs | | 4pcs |
| ⑤ |  | Support rods | | 4pcs |
| ⑥ |  | M8x40mm screw | | 8pcs |
| ⑦ |  | Hexagonal screw tap | | 1pcs |
| ⑧ |  | Connector | | 1pcs |
| ⑨ |  | M8x20mm screw | | 2pcs |

step4

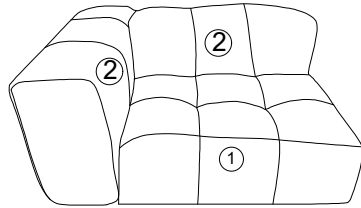

OR

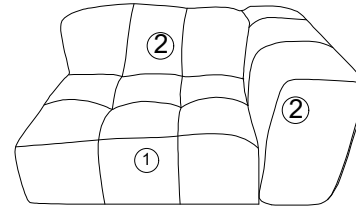

Installation 127-2

step5

Apply the connection buckles to connect the seats together(or not it's totally up to users).

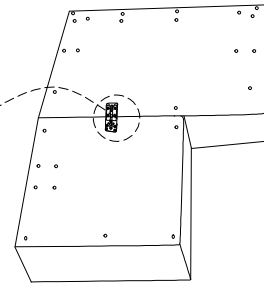
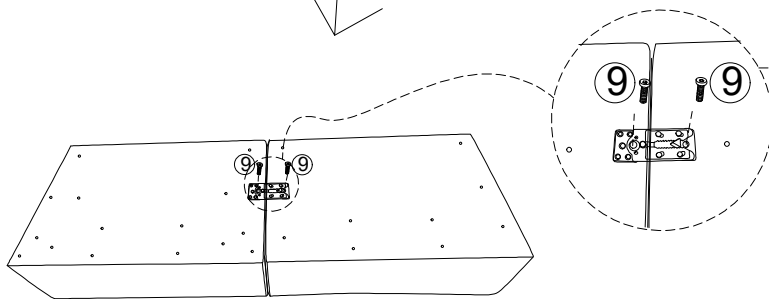
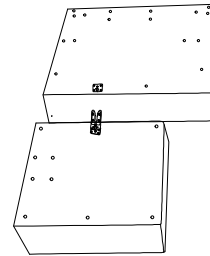
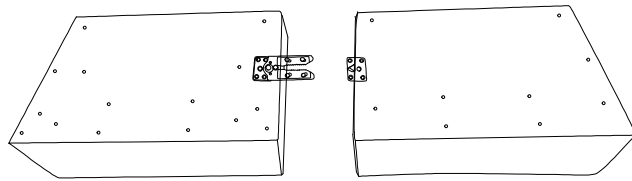

final

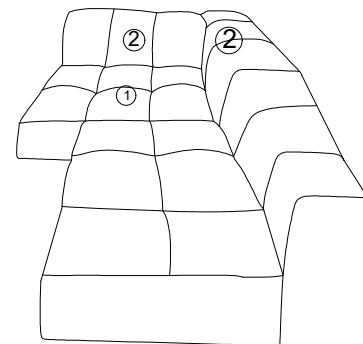
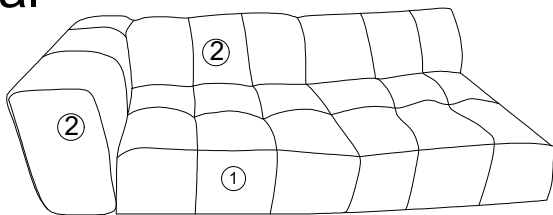

To avoid scratches and swallowing parts, please do not install by children!

| NO | Image | Parts Name | Size | Qty |
|----|-------|---------------------|------|------|
| ① | | Seat | | 1pcs |
| ② | | Backrest/Armrest | | 2pcs |
| ③ | | Back cushion | | 1pcs |
| ④ | | Legs | | 4pcs |
| ⑤ | | Support rods | | 4pcs |
| ⑥ | | M8x40mm screw | | 8pcs |
| ⑦ | | Hexagonal screw tap | | 1pcs |
| ⑧ | | Connector | | 1pcs |
| ⑨ | | M8x20mm screw | | 2pcs |

step1

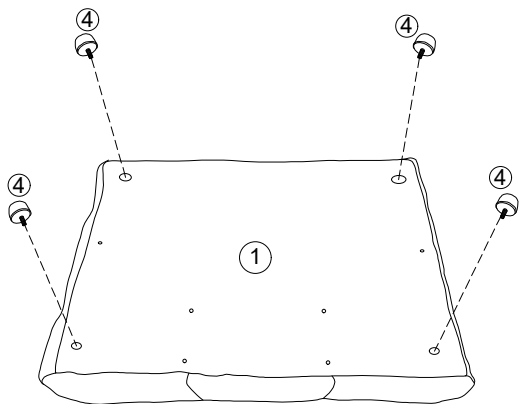

step2

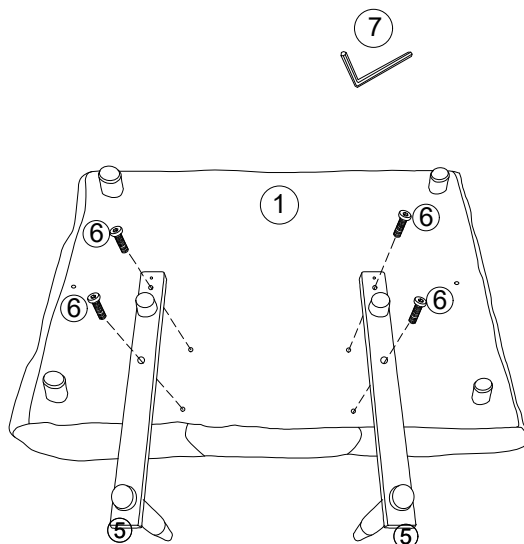

Installation 127-3

To avoid scratches and swallowing parts, please do not install by children!

step3

Pay attention to the direction of one end of the zipper, inward

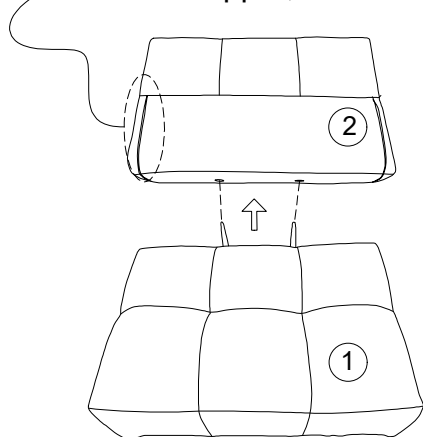

step4

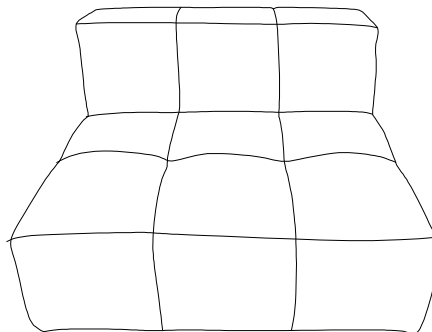

| NO | Image | Parts Name | Size | Qty |
|----|-------|---------------------|------|------|
| ① | | Seat | | 1pcs |
| ② | | Backrest | | 1pcs |
| ③ | | Back cushion | | 1pcs |
| ④ | | Legs | | 4pcs |
| ⑤ | | Support rods | | 2pcs |
| ⑥ | | M8x40mm screw | | 4pcs |
| ⑦ | | Hexagonal screw tap | | 1pcs |
| ⑧ | | Connector | | 1pcs |
| ⑨ | | M8x20mm screw | | 2pcs |

step5

Apply the connection buckles to connect the seats together (or not it's totally up to users).

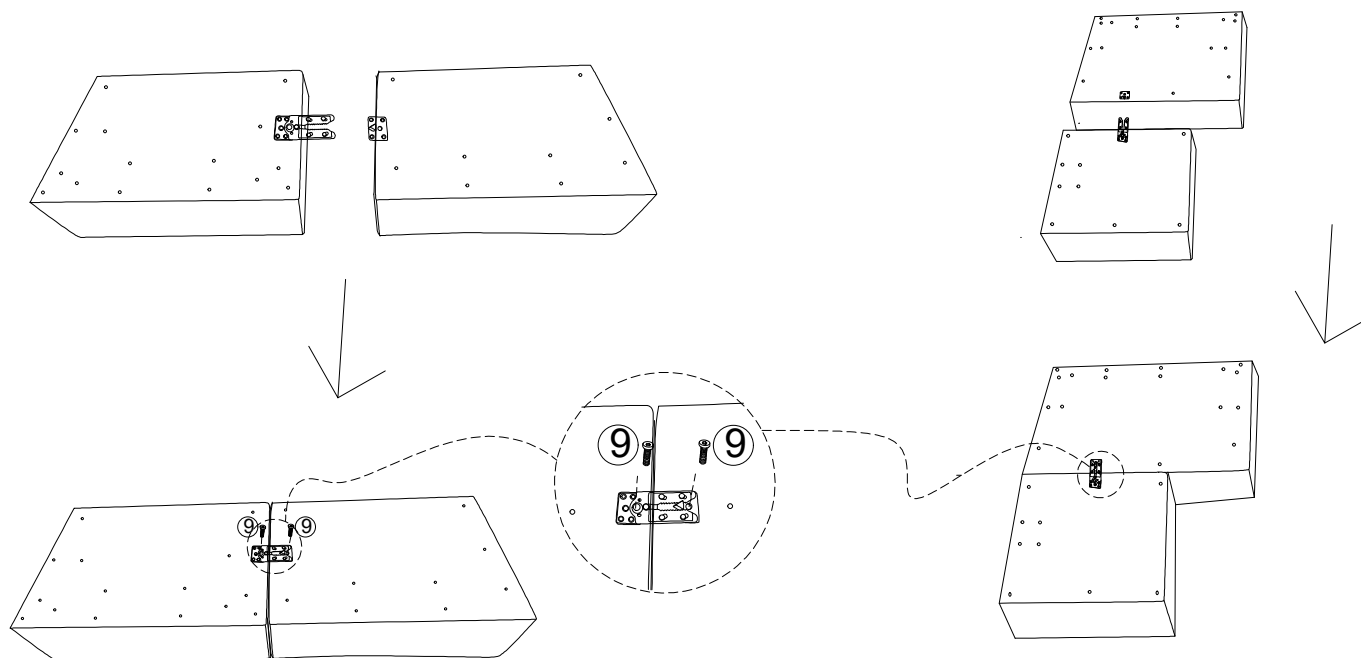

final

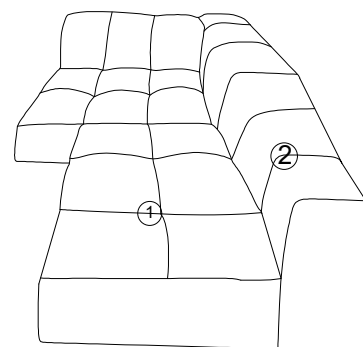
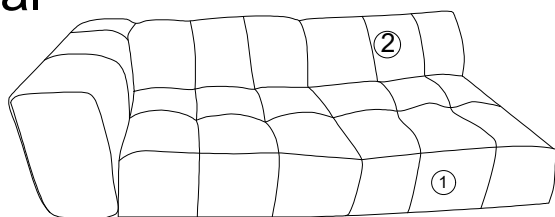

Installation 127-3

To avoid scratches and swallowing parts, please do not install by children!

| NO | Image | Parts Name | Size | Qty |
|----|-------|---------------------|------|------|
| ① | | Seat | | 1pcs |
| ② | | Backrest/Armrest | | 2pcs |
| ③ | | Back cushion | | 1pcs |
| ④ | | Legs | | 4pcs |
| ⑤ | | Support rods | | 4pcs |
| ⑥ | | M8x40mm screw | | 8pcs |
| ⑦ | | Hexagonal screw tap | | 1pcs |
| ⑧ | | Connector | | 1pcs |
| ⑨ | | M8x20mm screw | | 2pcs |

