

Vinci™

HANDS FREE CITRUS JUICER™



INSTRUCTIONS

www.vincihousewares.com | 888.735.3621 | support@vincihousewares.com

IMPORTANT SAFEGUARDS

When using electrical appliances, necessary safety precautions should always be taken, including the following:

- Read all instructions before first use.
- Make sure that your outlet voltage corresponds to the voltage stated on the rating label of the appliance.
- Close supervision is necessary when any appliance is used near children or by children.
- Always unplug the Vinci Hands Free Citrus Juicer when not in use and before cleaning.
- Avoid contact with any moving parts.
- Do not use the appliance outdoors.
- If the supply cord is damaged, it must be replaced by the manufacturer or its service agent or a similarly qualified person in order to avoid a hazard.
- To protect against fire, electric shock and injury to persons, do not immerse the appliance, cord or plug in water or other liquid. If this has happened, do not use this appliance anymore; dispose of the appliance.
- The use of accessories not recommended by the appliance manufacturer may result in fire, electric shock, or injury to persons.
- Unplug from outlet when not in use and before cleaning.
- Do not let cord hang over the edge of the table or counter or touch any hot surfaces.
- Do not place the appliance on or near a hot gas or electric burner or in a heated oven.
- Do not use the machine for other than the intended use.
- Always use Vinci Hands Free Citrus Juicer on a flat, stable surface.
- There are no user-serviceable parts inside. Return appliance to an authorized repair facility for service.
- If you think there may be an issue with your product, please contact customer support at 888-735-3621 or email support@vincihousewares.com.

**SAVE THESE INSTRUCTIONS
FOR HOUSEHOLD USE ONLY**

WARNINGS

WARNING:

- To reduce the risk of fire or electrical shock, do not disassemble or attempt to repair the Motor Unit.
- Repairs should be done by authorized service personnel only.
- Do not immerse the Motor Unit in any liquid.
- The Vinci Hands Free Citrus Juicer is intended for household use only.
- A short power-supply cord is provided to reduce the risks resulting from becoming entangled in or tripping over a long cord.
- If an extension cord is used, the marked electrical rating of the extension cord must be at least as great as the electrical rating of the appliance, and a longer cord should be arranged so that it will not drape over the countertop or tabletop where it can be pulled on by children or tripped over.
- This appliance has a polarized plug (one blade is wider than the other). To reduce the risk of electric shock, this plug is intended to fit into the outlet one way.
- If the plug does not fit into the outlet, reverse the plug and try to reinsert the plug into the outlet.
- Do not force the plug into the outlet.
- Do not attempt to modify the electrical plug in any way.
- If the plug still does not fit, please contact a qualified electrician.

OPERATING NOTICE: Always use care when using a knife to slice your citrus. Never put fingers or allow loose clothing to dangle inside the juicing dome, as the moving parts could seriously injure you.

**SAVE THESE INSTRUCTIONS
FOR HOUSEHOLD USE ONLY**



hello

TABLE OF CONTENTS

Important Safeguards..... 1
Warnings..... 2
Table of Contents 4
Welcome 5
Citrus Juicing 101..... 8
Getting to know your Vinci Hands Free Citrus Juicer 9
Assembling your Juicer 10
How to use your Hands Free Citrus Juicer 11
Tips 14
Care and Cleaning 15
Troubleshooting 17



HANDS FREE CITRUS JUICER

Thank you for your purchase of the Vinci Hands Free Citrus Juicer and welcome to the Vinci family!

Vinci's Hands Free Citrus Juicer makes juicing citrus virtually hands-free and effortless. Simply SLICE the fruit in half, PLACE the fruit on the Reamer, and PRESS the juice button. The juicer takes care of the rest.

With our PATENTED SMART AUTO JUICING TECHNOLOGY, there is no need to hold the fruit, strain your arm, or make a mess; the High Torque Motorized Base automatically raises the Juicing Reamer and Pulp Filter to extract the maximum amount of juice possible in about 10 seconds.

Our SMART PRESSURE SENSITIVE JUICING TECHNOLOGY has built-in sensors that automatically sense the thickness of the citrus rind, ensuring you always get the best and optimal amount of juice without any bitter flavors that are often introduced when the peel is scraped by the reamer of other juicers. Use the Vinci Hands Free Citrus Juicer on all kinds of citrus, from small key limes to large 4.5-inch grapefruit.

To learn more about our other products and to sign up for our newsletter, receive news, recipes and offers, visit us at www.vincihousewares.com.

*Register your Vinci Hands Free Citrus Juicer at <https://vincihousewares.com/pages/product-registration>.

www.vincihousewares.com | 888.735.3621 | support@vincihousewares.com



welcome



citrus juicing 101

WHY FRESH CITRUS JUICE?

Fresh citrus juice has been enjoyed by many cultures for millennia, not only for the taste but also for the abundance of health benefits.

Fresh citrus juice is packed with vitamins and minerals and boasts many more health benefits than its counterpart, store-bought pasteurized citrus juice. Not only is fresh citrus juice better for you, it also has a superior taste straight from the fruit.

IS CITRUS JUICE JUST FOR DRINKING?

We are glad you asked, no. Although fresh citrus juice is wonderfully delicious straight from a glass, it is also used by most cultures in their cuisine. Use fresh citrus juice in all kinds of recipes from marinades, appetizers, desserts, cocktails, mocktails, and entrees.

To learn more about our other products and to sign up for our newsletter, receive news, recipes and offers, visit us at www.vincihousewares.com.

GETTING TO KNOW YOUR HANDS FREE CITRUS JUICER

Before first use, please remove all packaging and any labels or stickers from your Vinci Hands Free Citrus Juicer. Be sure that all parts listed below of your new Hands Free Citrus Juicer have been included before discarding any packing materials.

Before using your Hands Free Citrus Juicer for the first time, please familiarize yourself with the various parts of the machine and how it functions. Carefully read all the instructions.

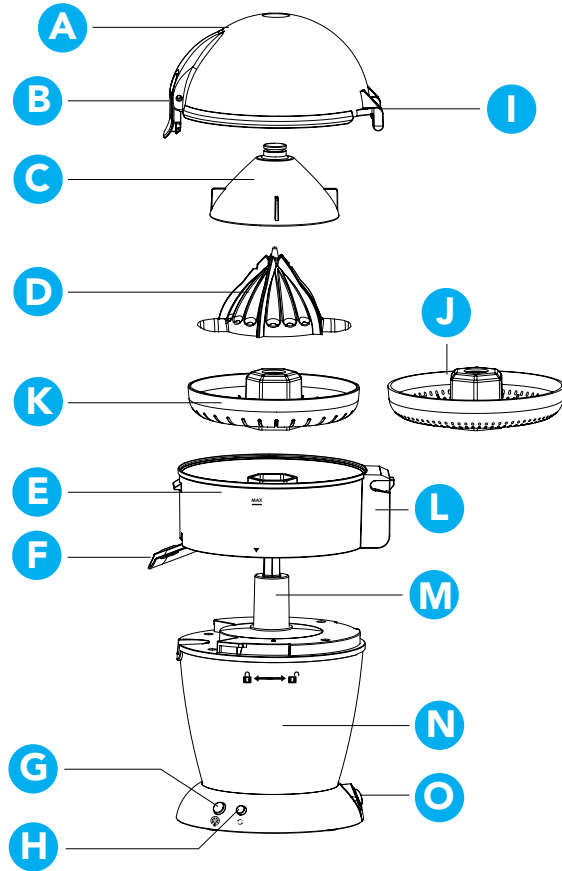

- A. Lid
- B. Latch
- C. Holding Cone
- D. Reamer
- E. Juice Bowl
- F. Locking Juice Spout
- G. Auto Juice Button
- H. Reset Button
- I. Hinge
- J. Fine Pulp Filter
- K. Coarse Pulp Filter
- L. Hinge Release
- M. Drive Coupler
- N. Motor Unit
- O. Power Switch
- Q. Instruction Manual

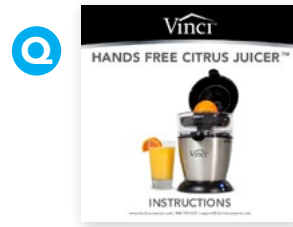

ASSEMBLING YOUR JUICER

Before first use, wash your Juice Bowl, Reamer, Filter, and Lid with warm soapy water.

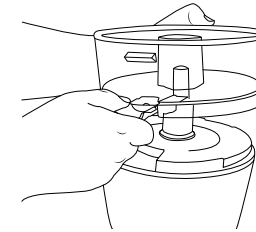

1. Place Juice Bowl (E) on to Motor Unit, lining up the Drive Coupler (M) on the Motor Unit with the hole in the Juice Bowl.

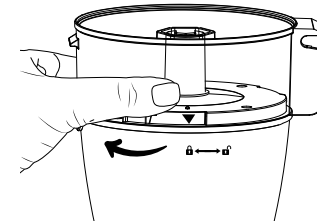

3. Turn Juice Bowl to your left until it locks into place and the Juice Bowl lines up with the lock graphic on the Motor Unit.

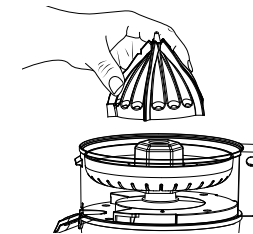

5. Place Reamer (D) onto Drive Coupler and Pulp Filter.

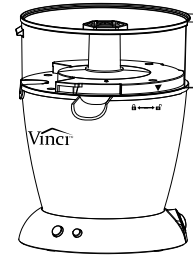

2. Looking straight at the unit, the Locking Juice Spout (F) should be placed just to the right of the Vinci logo.

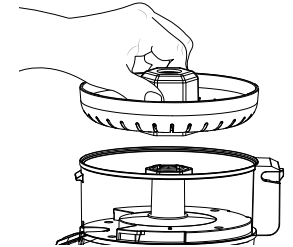

4. Position desired Pulp Filter (J or K) onto Drive Coupler.

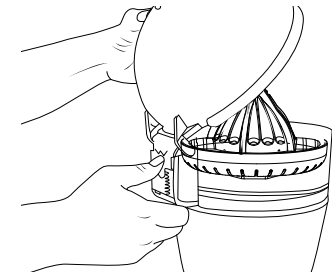

6. Insert Lid (A) on to the Juice Bowl by sliding the Hinge Release (L) button down, aligning the tabs on the Hinge (I) with the holes in Hinge Release, and sliding the Lid into place. Close Lid.

HOW TO USE YOUR HANDS FREE CITRUS JUICER



How To:
See it in Action!

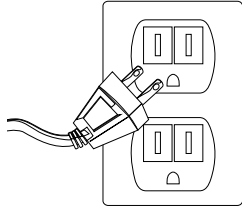

1. Place your Vinci Hands Free Citrus Juicer on a flat surface, and plug the power cord into a suitable outlet.

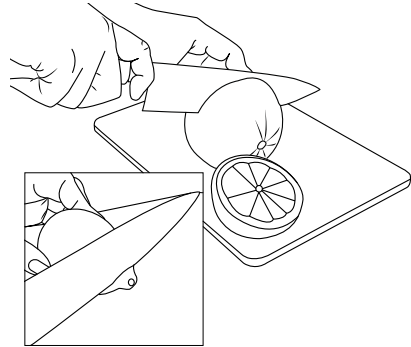

2. Slice your desired citrus fruit in equal halves. The fruit should be sliced cross-wise into two equal portions, as shown. If the fruit has an oversized end or excess rind, it is suggested to cut it off before juicing.

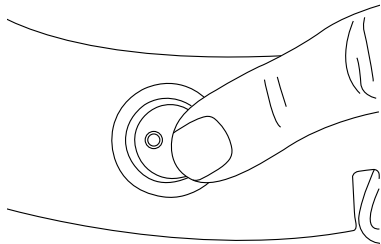

3. Turn on the juicer by pressing the Power Switch to ON. The Power Switch is located on the back of the juicer. When the juicer is on, the the Power Switch will be illuminated red, and the Juice Button will be illuminated and flash blue.

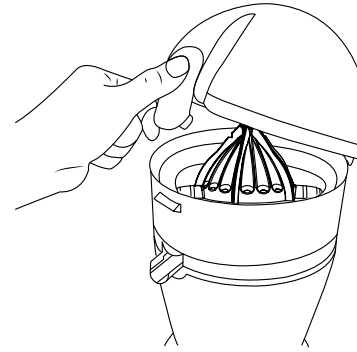

4. Lift the Latch to open the Lid.

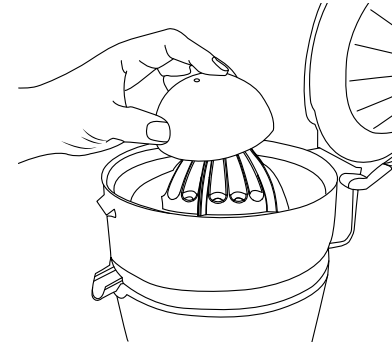

5. Using moderate pressure, place the fruit centered on the Reamer, and lightly press into place so that it is securely fitted on the Reamer.

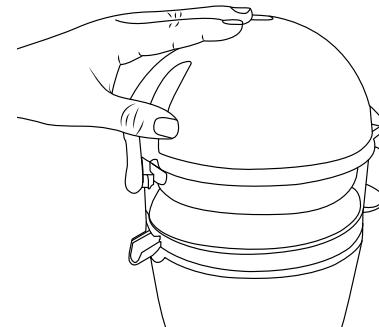

6. Close the Lid, ensuring the Lid is latched correctly so it will not open during the juicing process.

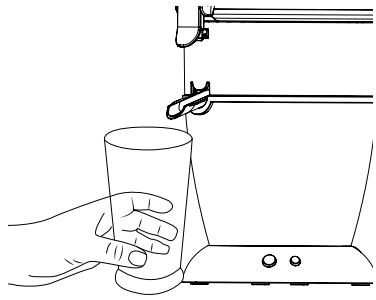

7. Place a glass under the Juice Spout. If the Juice Spout is in the UP position, the juice will collect in the Juice Bowl. If the Spout is in the DOWN position, the juice will flow freely into the glass.

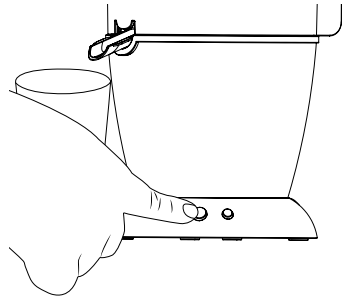

8. Press the Auto Juice Button. The motor will start, and the Reamer will automatically raise, extracting the juice. There will be a short pause; then, the Reamer will automatically lower. When the motor stops, the juicing is completed. The Auto Juice Button is illuminated solid blue during the juicing process, and reverts to flashing blue at the end of the juicing process.

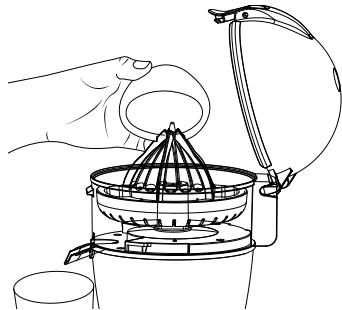

9. Open the Lid by lifting the Latch and pulling up. Remove the juiced fruit and repeat process until you have juiced all your desired citrus.

NOTE: The Vinci Hands Free Citrus Juicer includes a safety feature that suspends the juicing process in case the motor is exposed to excessive forces or if the power is interrupted. If the juicer is in the suspend mode, the Reamer will be in a raised position, and the Reset Button will flash blue and there will be continuous audible beeps. By pressing the flashing Reset Button, the juicer will re-initialize; the Reamer will return to the down (home) position, the audible beeps will terminate, and the Reset Button will no longer be illuminated.

Important: Turning on and off the power or unplugging the juicer will NOT perform the reset operation. You must press the Reset Button.

tips

- The large capacity Juice Bowl holds 12 oz of juice; if juicing more than that, transfer juice to a glass or pitcher. Never fill the Juice Bowl past the MAX indicator.
- The largest diameter of fruit to be used is 4.5" - or the size of an oversized grapefruit. Regular sized grapefruit under 4.5" is recommended for use with the Vinci Hands Free Citrus Juicer.
- When selecting citrus to juice, you should look for the ones that do not have any blemishes, soft spots, dents, cuts, or mold. Pick fruit that is slightly heavy for their size; this means that they're "liquid" dense and typically sweeter and juicier.
- Never insert more than one citrus half in the juicer; you can only juice one piece of citrus at a time.
- Never open the Lid during the juicing process.
- If desired or necessary, you can clean excessive pulp that has been retained by the Pulp Filter in between juicing.
- Try mixing it up and combining different citrus juices for fun variations- such as orange and grapefruit, or tangerine and lime!
- There almost 100 different citrus varieties and hybrids throughout the world, many of which have delicious juice. Try different types to drink and cook with- such as mandarins, blood oranges or clementines.
- Don't want to waste the leftover rind? Try making candied lemons, oranges, or grapefruit.



CARE AND CLEANING

Always unplug the juicer from the wall before performing any cleaning or maintenance. For easy cleaning, the Vinci Hands Free Citrus Juicer quickly disassembles, and all parts except for the Motor Unit can be washed by hand or in the dishwasher on the top shelf.

Follow the steps below to disassemble the juicer for cleaning after each use.



Cleaning:
See it in Action!

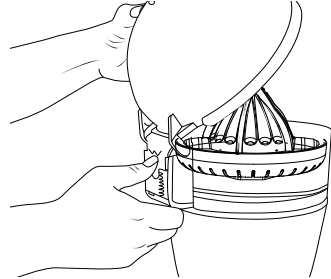

1. Remove the Lid by sliding the Hinge Release button down and detaching the Lid from the Juice Bowl.

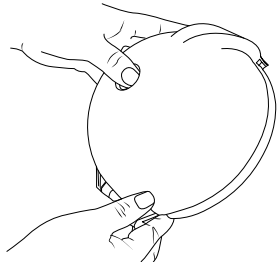

2. Remove the Holding Cone by tightly grasping the Lid with the domed part facing up. Firmly press down on the top of the Holding Cone to remove it from the Lid.

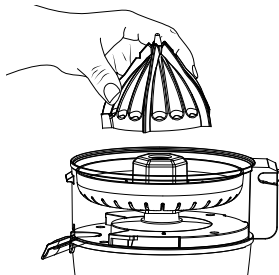

3. Remove the Reamer by grasping the Reamer and pulling up to remove it from the Drive Coupler.

CARE AND CLEANING

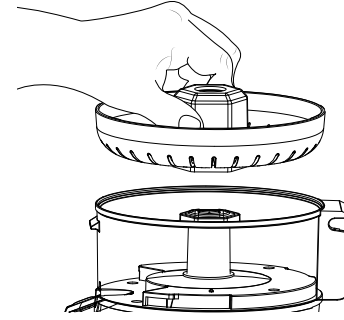

4. Remove the Pulp Filter by pulling straight up to remove it from the Juice Bowl. Dispose of excess pulp.

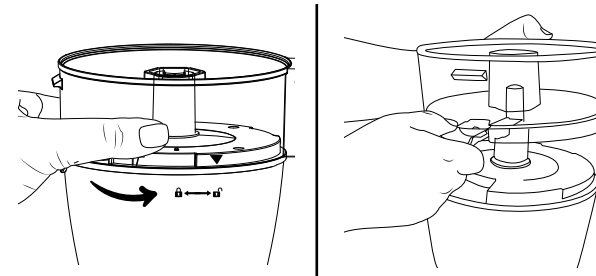

5. Remove the Juice Bowl (Ensure the Juice Spout is in the UP position). Grasp the Juice Bowl and turn counterclockwise until the arrow on the Juice Bowl lines up with the Unlock graphic on the Motor Unit. Lift the Juice Bowl straight up to remove it from the Motor Unit.

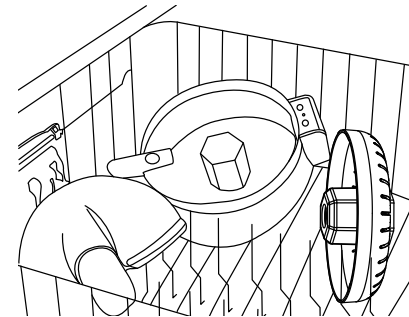

TOP RACK ONLY

6. Wash all removable parts with warm, soapy water or in the dishwasher - **TOP RACK ONLY**. Wipe down Motor Body with a clean, damp cloth and dry. Use only natural cleaners on Motor Body. Never use abrasive, harsh cleaners.

TROUBLESHOOTING

PROBLEM	POSSIBLE CAUSE	SOLUTION
The Lid to the Juicer will not close or stay closed during use	<ol style="list-style-type: none"> 1. The fruit is not cut in halves, but rather in 3/4 2. The fruit has an over sized end (or section that attaches to the stem) 3. The fruit is over 4.5" 	<p>Slice the top of the fruit off to make a smaller portion</p> <p>Trim extra rind and oversized end from the top of the fruit</p> <p>Use only fruit less than 4.5" in diameter</p>
The Juicer stopped working midway through juicing	You temporarily lost power, or the motor became jammed- if so, the reset button will be beeping and flashing blue	Press reset button to return reamer to home position
I press the juice button, but nothing happens	The unit may not be plugged in or power switch may be off	Check that plug is securely in socket and that outlet is functioning. Check to make sure power is switched to "on"
The Lid will not detach from the Juice Bowl	You are not sliding down the Hinge Release Button	Slide down the Hinge Release Button and remove Lid

TROUBLESHOOTING

PROBLEM	POSSIBLE CAUSE	SOLUTION
Sometimes the Juice Bowl spins and unlocks when the Reamer is returning to the down (home) position	The fruit is getting stuck in the Holding Cone, causing the Juice Bowl to spin when the Reamer reverses direction	<ol style="list-style-type: none"> 1) Lower the Juice Spout. The Juice Bowl cannot rotate when the Juice Spout is in the down position. 2) Make sure the fruit being juiced doesn't have excessively thick rind. 3) Trim extra rind and the oversized ends from the top of the fruit.

If you think there may be an issue with your product, please contact customer support at 888-735-3621 or email support@vincihousewares.com.



www.vincihousewares.com | 888.735.3621 | support@vincihousewares.com

F/N-v6_BL