

Adjustable Closet Rod 48-72"
Polished Chrome

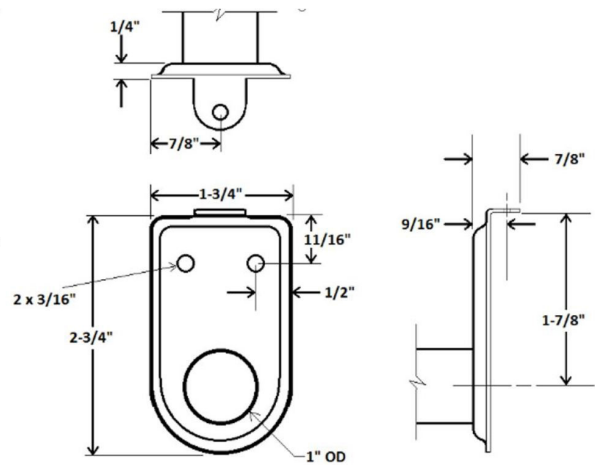

SPECIFICATIONS

MATERIAL CONSTRUCTION:	Steel
MOUNTING HARDWARE INCLUDED:	Yes
TOOLS NEEDED FOR INSTALLATION:	Screwdriver
ASSEMBLED DIMENSIONS:	1" H x 72" L x 1" D
ASSEMBLED WEIGHT:	2.0944 lbs.
CROSS BORE:	N/A
CORNER RADIUS:	N/A
PROJECTION:	N/A
HINGE TYPE:	N/A
NUMBER OF HOOKS:	0

WARRANTY: 1-Year limited warranty

LEGAL FOR SALE IN CALIFORNIA: Yes



TYPE:
JOB:
ORDER CODE:
APPROVALS: