

seville classics®

4-Tier Freestanding Garment Rack Closet Organizer

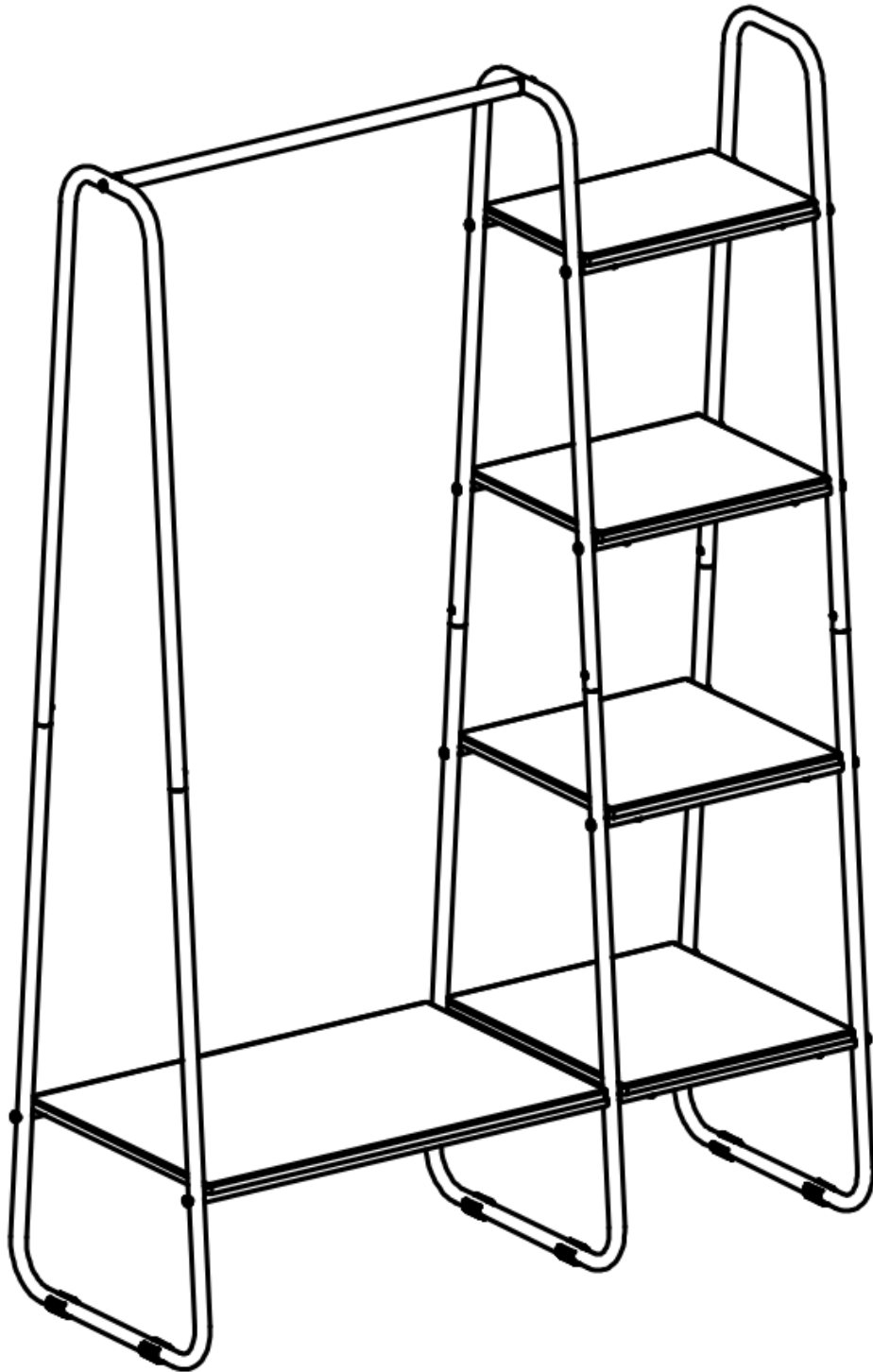

Model: WEB651

Thank you for choosing Seville Classics! We hope that you enjoy your new garment rack. Please read through this user guide for parts list, assembly instructions, frequently asked questions and contact information.

Parts List

A. Top right frame (1)

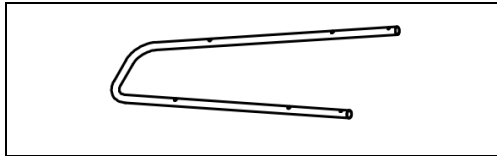

B. Top center frame (1)

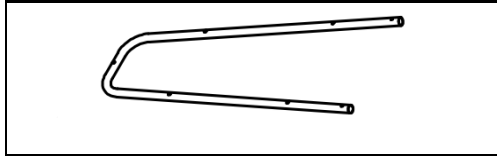

C. Top left frame (1)

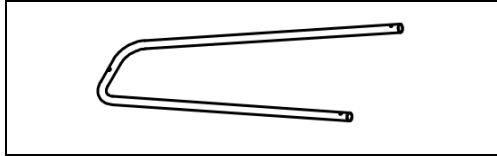

D. Right base frame (2)

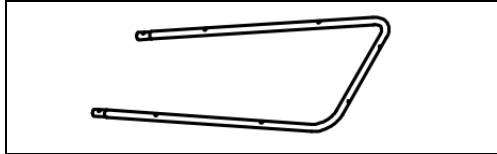

E. Left base frame (1)

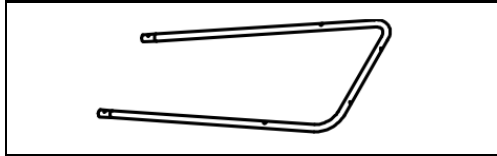

F. Short poles (8)

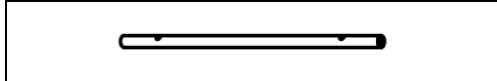

G. Base poles (2)

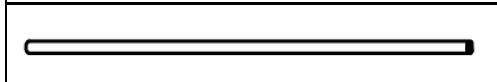

H. Top pole (1)

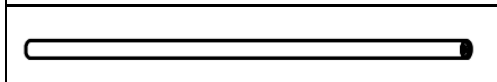

I. Top shelf (1)

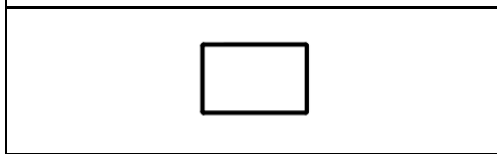

J. Top mid. shelf (1)

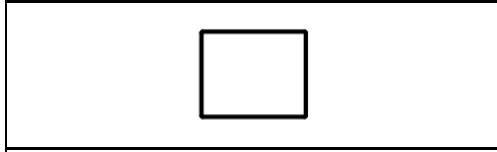

K. Lower mid. shelf (1)

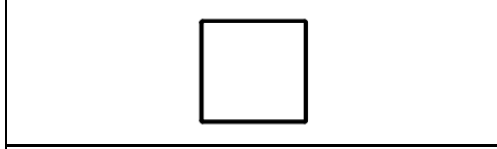

L. Bottom shelf (1)

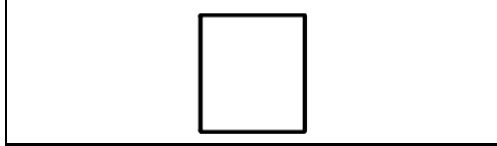

M. Wide shelf (1)

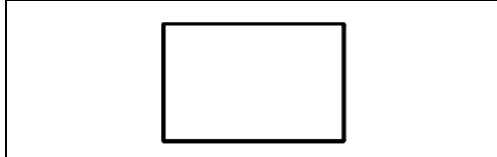

N. Foot (4)

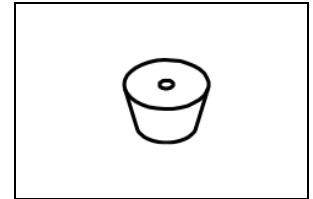

O. Washer (2)



P. Clip (6)



Q. Frame screw (6)



R. Wide shelf screw (4)



S. Shelf screws (16)



T. Hex screws (18)

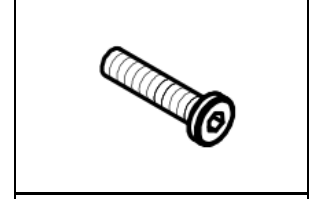

U. Connector screws (2)

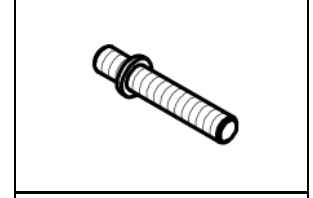

V. Hex key (1)

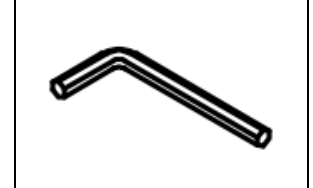

Please make sure you have all the parts on this list.

If you're missing parts, contact us for replacements at
(800) 323-5565 or send an email to Support@SevilleClassics.com

Assembly Instructions

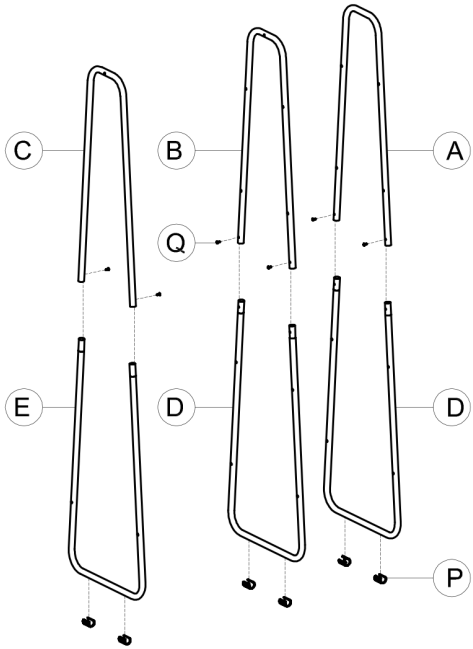

Step 1.

Slide TOP FRAMES (A, B, C) onto LOWER FRAMES (E, D).

Attach with SCREWS (Q) to make LEFT FRAME (C, E), CENTER FRAME (B, D), and RIGHT FRAME (A, D).

Clip FEET (P) onto bottom of frames.

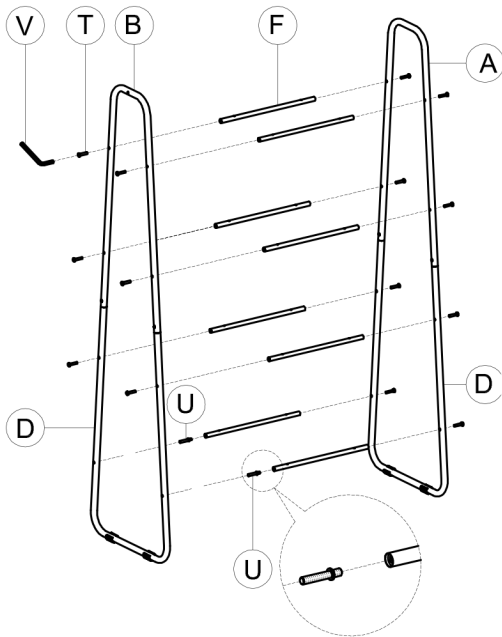

Step 2.

Screw CONNECTOR SCREWS (Q) into ends of two SHORT POLES (F) with long ends outside. Insert the long ends through the bottom screw holes on the CENTER FRAME (B, D). Attach with HEX SCREWS (T) to RIGHT FRAME (A, D).

Connect the right and center frames from with SHORT POLES (F) using HEX SCREWS (T) and HEX KEY (V).

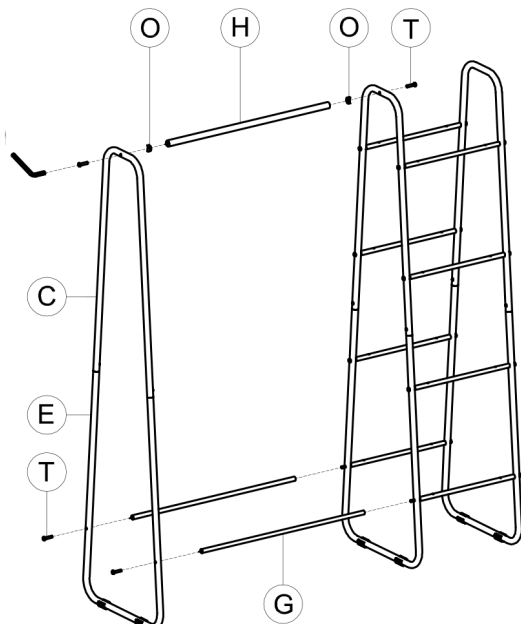

Step 3.

Screw BASE POLES (G) to the CONNECTOR SCREWS (Q). Attach to LEFT FRAME (C, E) with HEX SCREWS (T).

Fit HEX SCREW (T) through screw hole in top of left frame. Fit curved side of WASHER (O) over screw threads all the way to the frame. Screw TOP CROSSBAR (H) onto threads.

Attach TOP CROSSBAR (H) to middle frame with WASHER (O) and HEX SCREW (T).

Tighten all hex screws until snug.

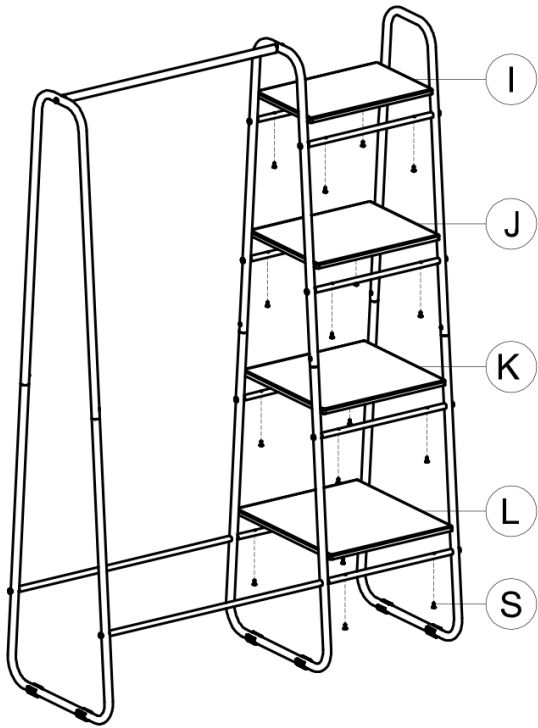

Step 4.

Attach SHELVES (I, J, K, L) from top to bottom with SHELF SCREWS (S).

Step 5.

Attach FEET (N) to bottom of WIDE SHELF (M) with WIDE SHELF SCREWS (R).

Place WIDE SHELF on BASE POLES to finish.

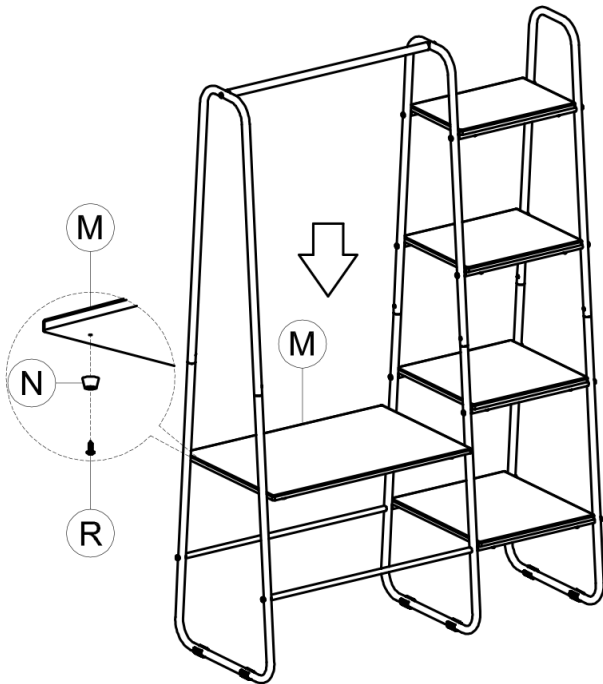

Customer Service Information

Telephone: (800) 323-5565

Fax: (310) 533-3899

Hours: 8:30 AM – 4:30 PM (PST)

Email: Support@SevilleClassics.com

Homepage: www.SevilleClassics.com