

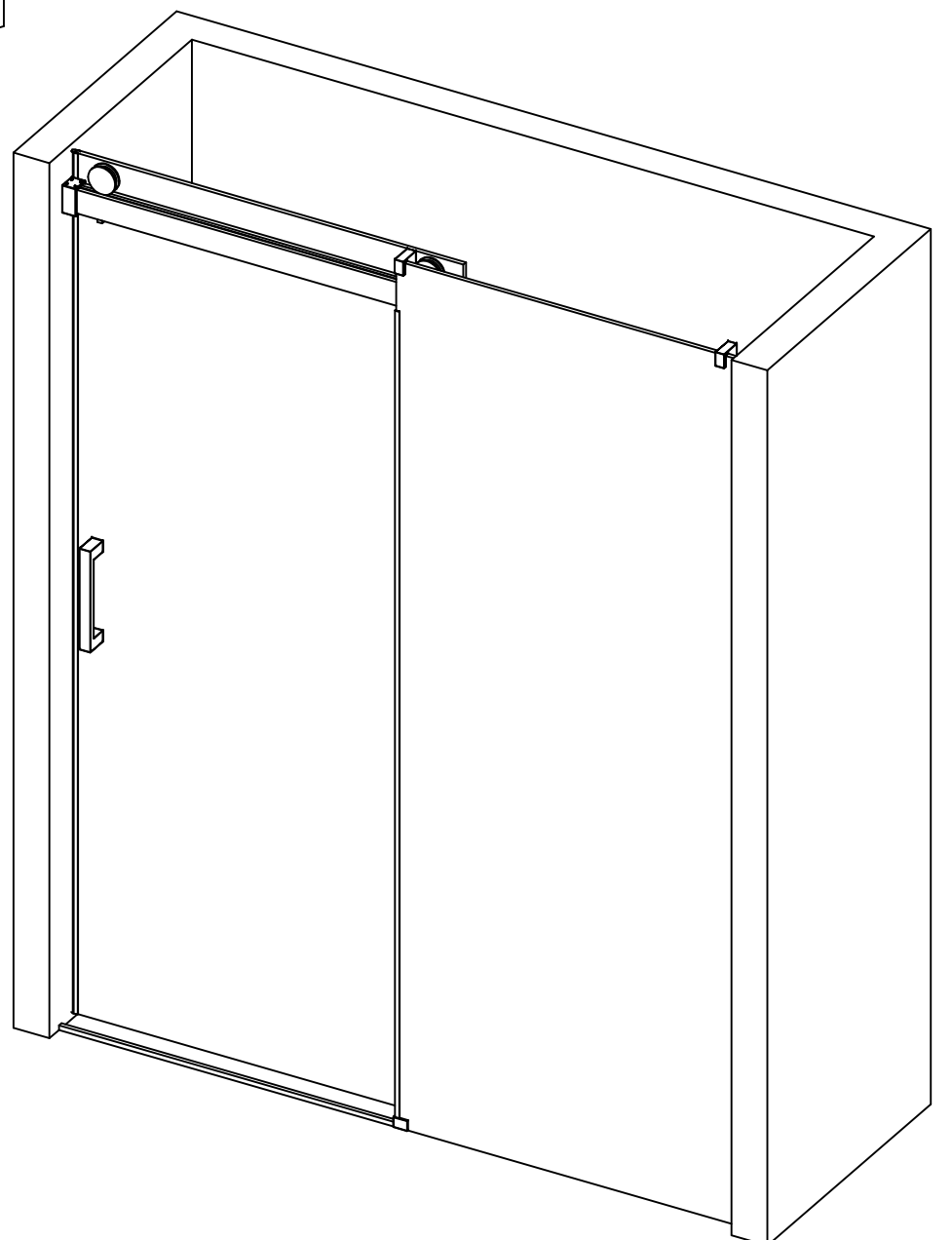

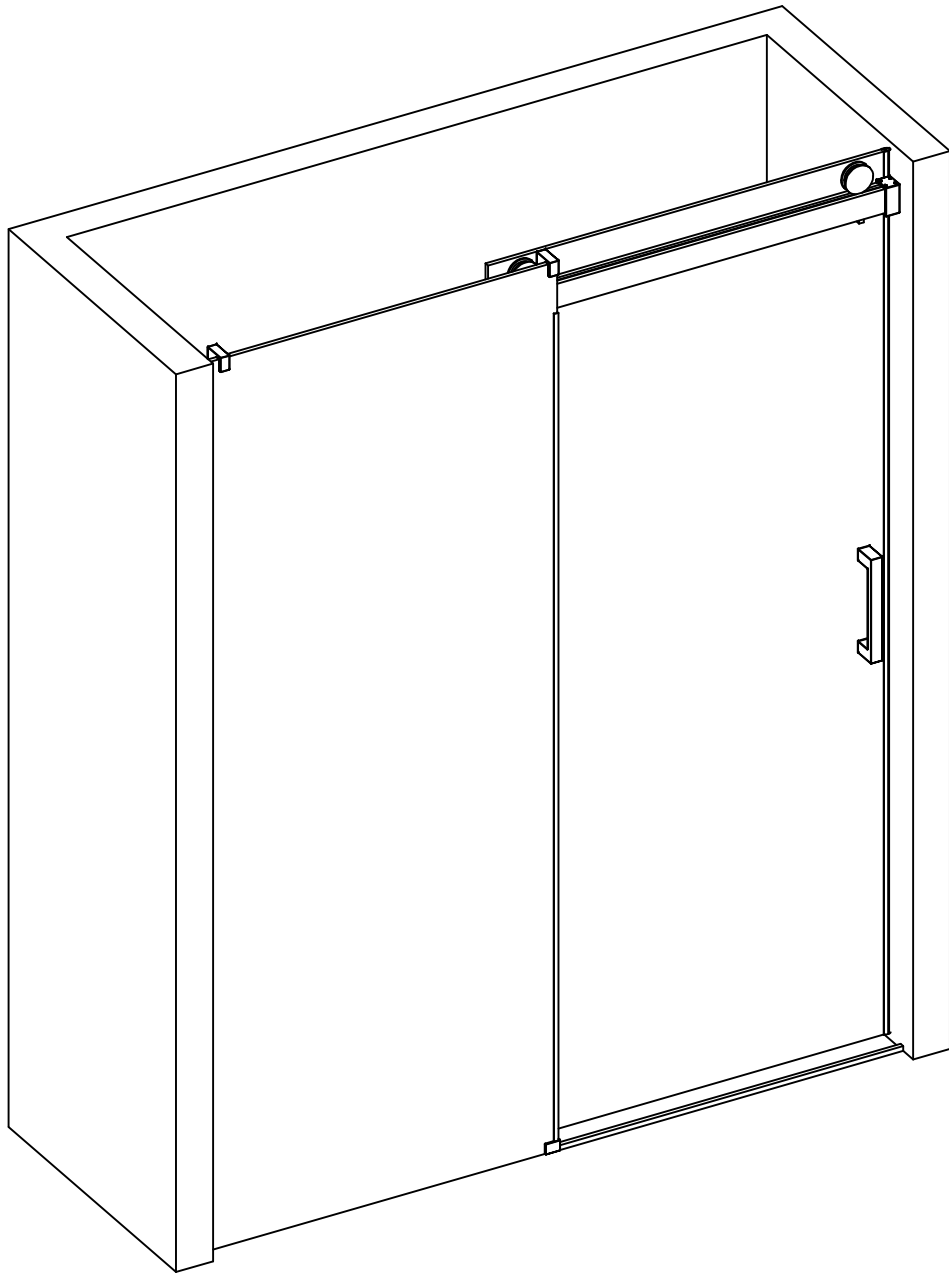







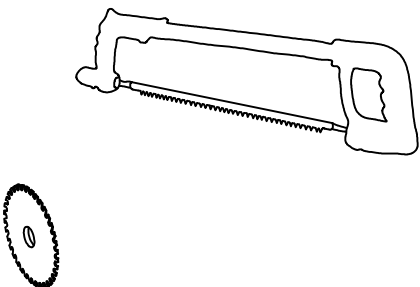
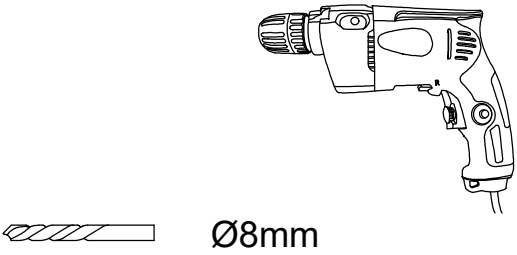

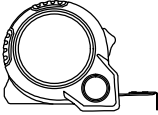
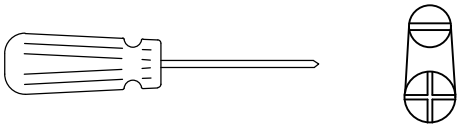
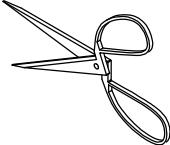
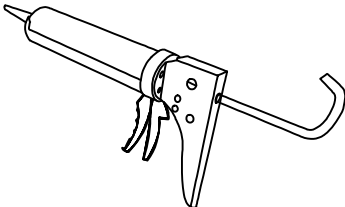
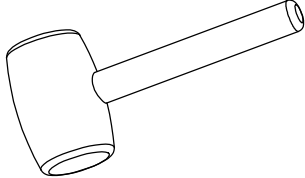
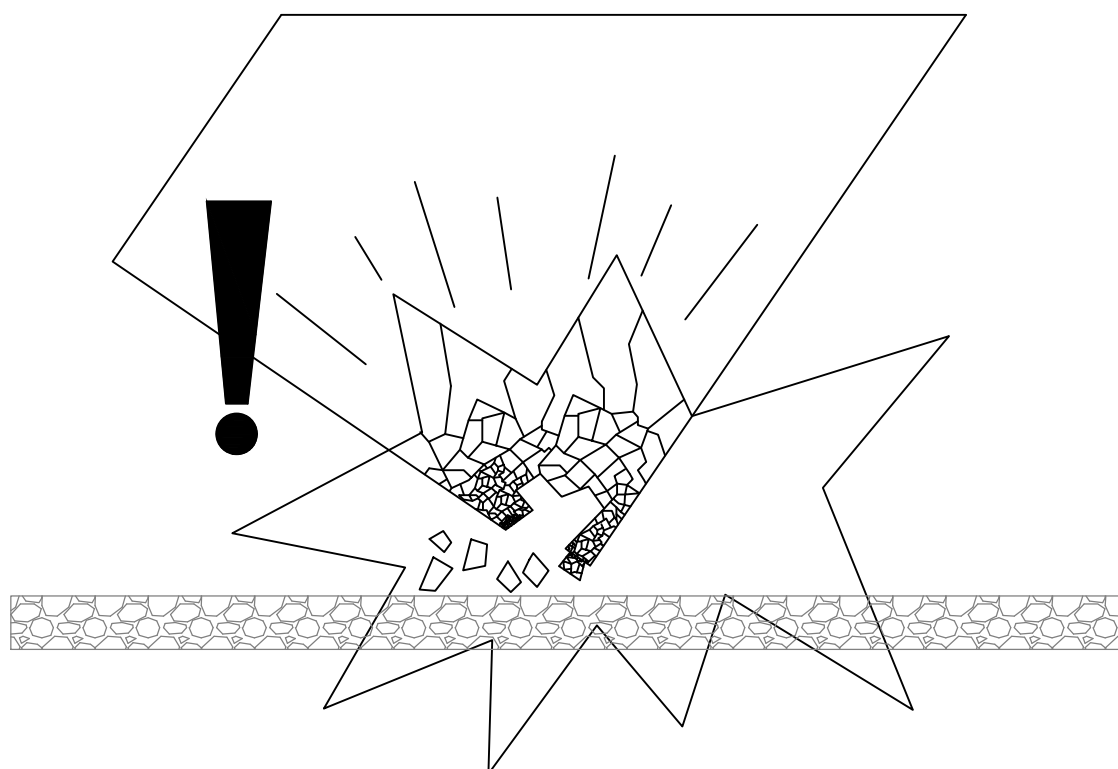
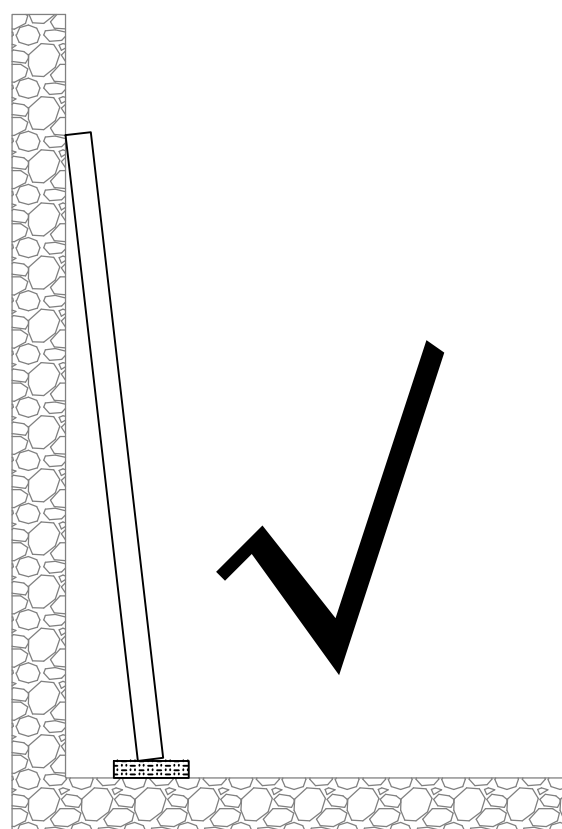
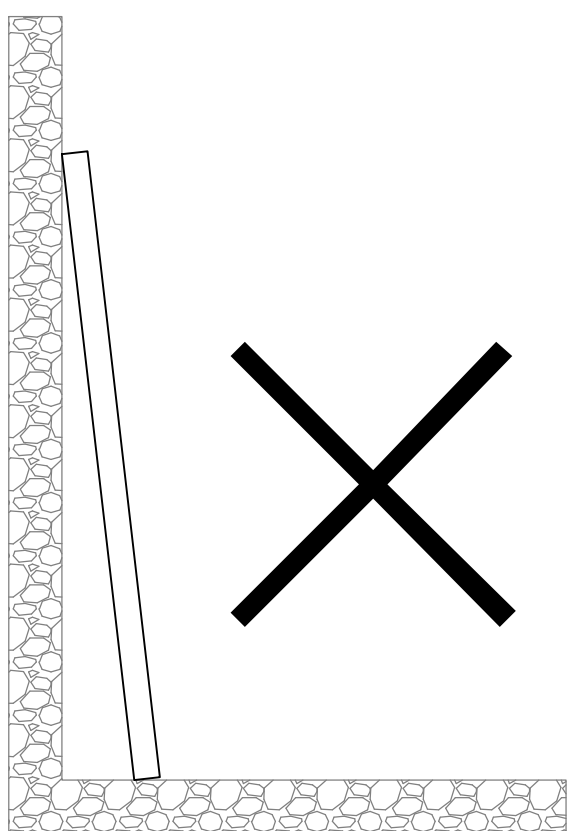
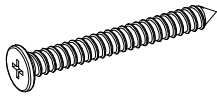
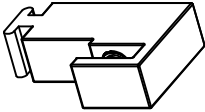
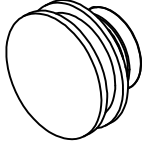

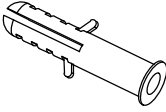
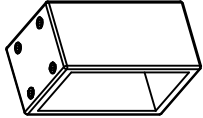
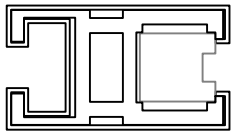
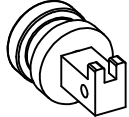
21S1001

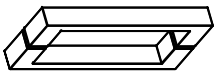

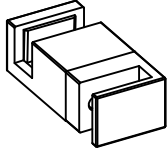
		 <p>Ø8mm</p>
		
		

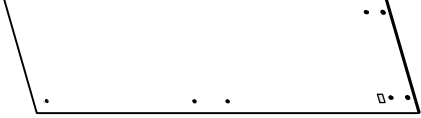

Serial Number	Graphical	Name	Quantity	Remark
01		ST5x45	4 PCS	
02			2 PCS	
03			2 PCS	
04			1 PCS	
05			4 PCS	
06			2 PCS	
07			1 PCS	
08			2 PCS	
09			1 PCS	
10			1 PCS	
11			1 PCS	
12			1 PCS	
13			1 PCS	
14			1 PCS	
15			1 PCS	
16			1 PCS	

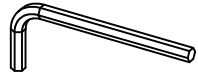
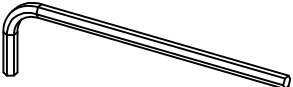
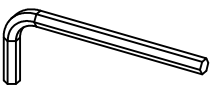
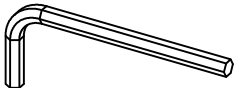
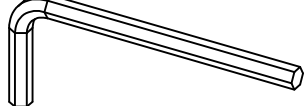
Serial Number	Graphical	Name	Quantity	Remark
17		M2.0	1 PCS	
18		M2.5	1 PCS	
19		M3.0	1 PCS	
20		M4.0	1 PCS	
21		M5.0	1 PCS	

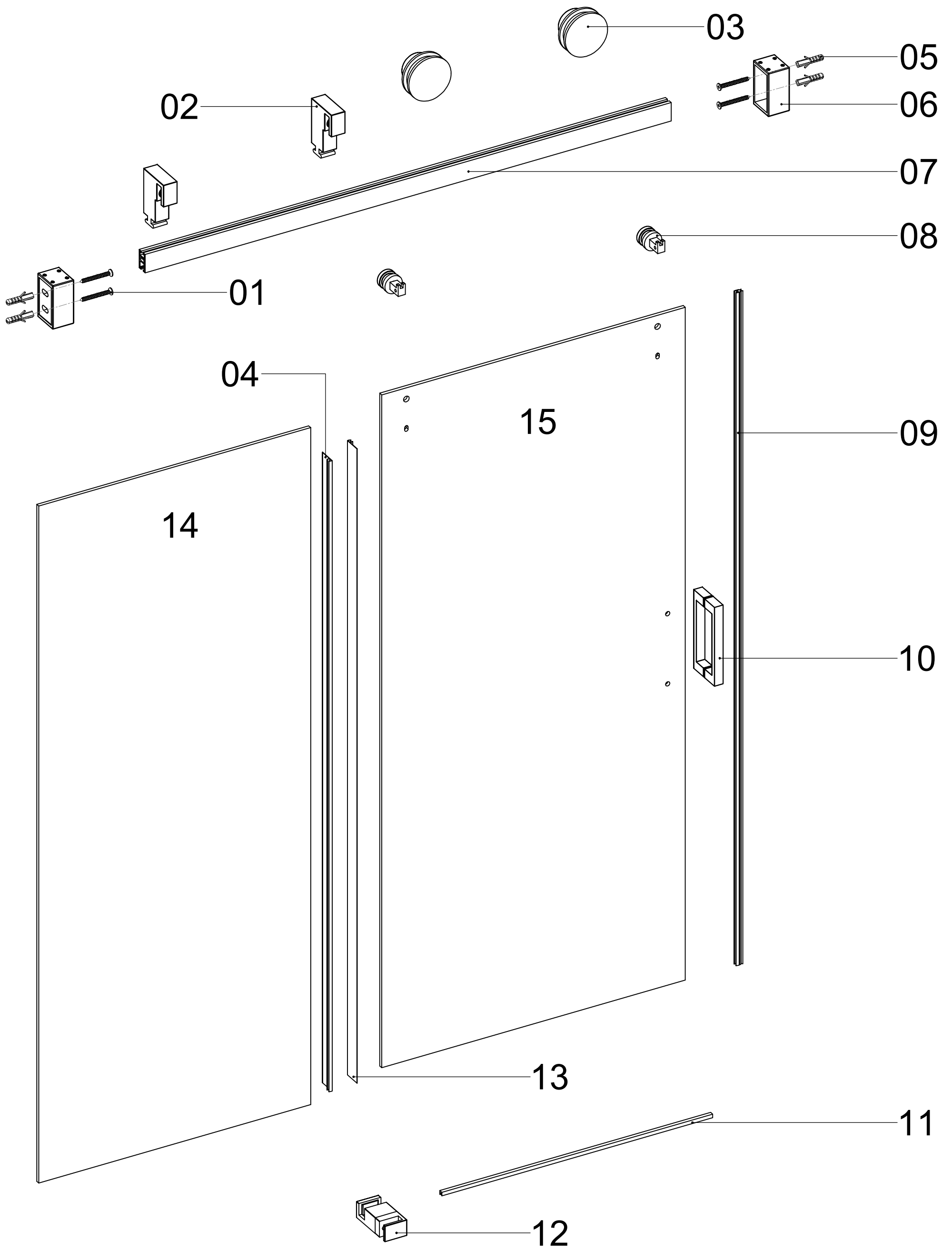

L	A(mm)
1524	1520-1540
1830	1826-1846

