

CITYPOST

SIMPLE · AFFORDABLE



Ordering Guide

ABOUT CITYPOST

It has been said that necessity is the mother of innovation, and that is certainly true about CityPost. CityPost was founded when three friends with backgrounds in engineering, construction, and product development were trying to find a simple cable railing system that would fit into their budget while building spec homes. After searching the internet and talking with dozens of construction suppliers they were unable to find what they were looking for, so they decided to create it themselves. By standardizing on the highest quality components coupled with a patented top rail bracket, CityPost has quickly become the most simple and affordable cable railing system available in the market today. With the ability to choose the desired railing length, height, color, and mounting type the CityPost cable railing system provides nearly infinite flexibility to meet the needs of even the most complicated project.



HOW TO USE THIS GUIDE

Are you installing near salt water?

If installing within five miles of saltwater, contact vendor directly for marine grade options. Reach out at **855-GET-CITY** or visit **WWW.CITYPOST.COM**.

STEP 1: SELECT YOUR RAILING MOUNT



BASE MOUNT



FASCIA MOUNT



FASCIA STAIRS

STEP 2: SELECT YOUR RAILING HEIGHT

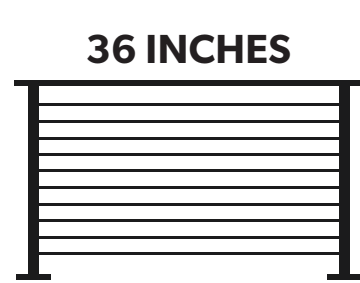

36 INCHES

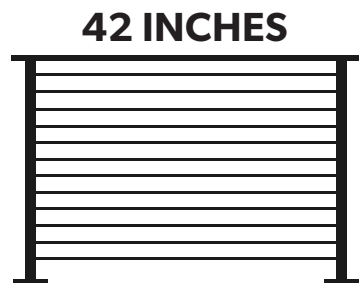

42 INCHES

i Remember: Always check with your local code for railing requirements.

STEP 3: SELECT YOUR RAILING ORIENTATION

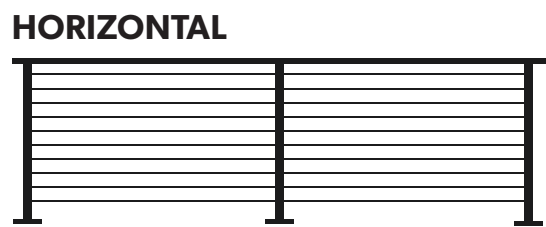

HORIZONTAL

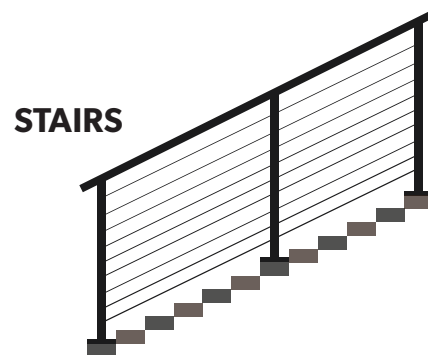

STAIRS

STEP 4: SELECT YOUR RAILING COLOR



BLACK



BRONZE



GREY



WHITE

STEP 5: MEASURE YOUR PROJECT

Measure each side of your deck. For each side/section you will order one kit. Each kit will include enough posts, hardware to cover one section.

You will be able to customize to your exact length since you will cut the cable on site and the top rail can be cut down as well as be extended using the connecting sleeves we provide for any kit over 6'.

- A** 12 Foot Deck Cable Railing
(Order 12' kit in corresponding mounting type /color you desire)
- B** 12 Foot Deck Cable Railing
(Order 12' kit in corresponding mounting type /color you desire)
- C** 4 Foot Deck Cable Railing
(Order 6' kit in corresponding mounting type /color you desire)
- D** 9 Foot Deck Cable Railing
(Order 10' kit in corresponding mounting type /color you desire)
- E** 8 Foot Stair Cable Railing
(Order 8' kit in corresponding mounting type /color you desire)
- F** 90 Degree Corner Sleeve (2)
- G** 90 Degree Deck-to-Stair Sleeve (2)

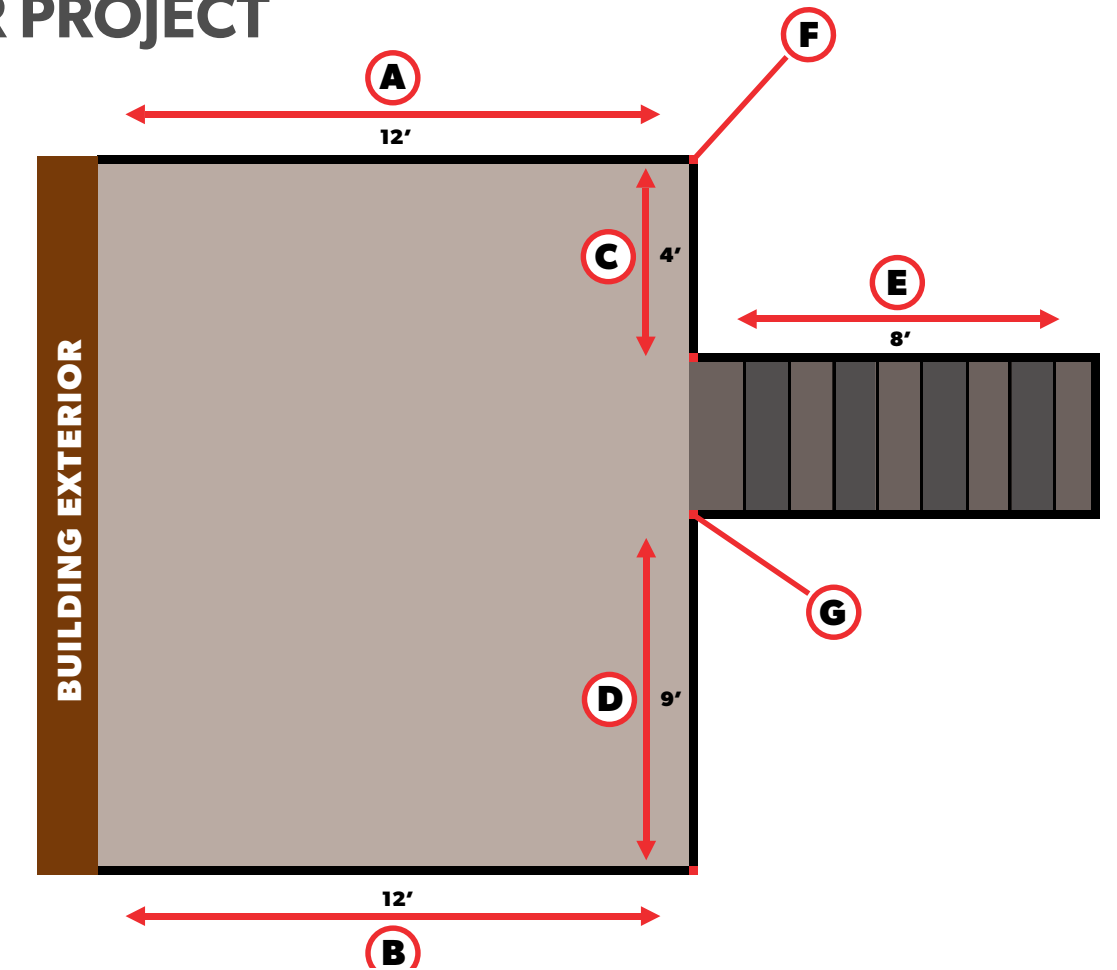

NOTE: The 6' kit is the only two post kit and will service any section 6' or less.



If installing within five miles of salt-water, contact vendor directly for marine grade options at **855-GET-CITY**.

STEP 6: SELECT YOUR MODEL NUMBERS

After you've measured your project, determined your sleeves, selected your height, and chosen your color, you are ready to find your model numbers and place your order with Home Depot. The next pages will provide you with our entire catalog. Simply find your model numbers and add them to your online cart or order at the Home Depot Pro Desk. Note, swaging tool and cable cutter not included. Not recommended within three miles of salt water (order stainless steel post option in that case).

STEP 7: SELECT YOUR ACCESSORIES

After you have added your CityPost kits to your cart you may need to order some additional items. Pages 16-18 in this catalog provide the item numbers for our kit accessories.

FREQUENTLY ASKED QUESTIONS

What do I get in the kit?

Each kit that you purchase will come disassembled with all of the hardware, toprail pieces and enough posts to where you will not have to spread them more than 6' apart. As long as you order one kit for each side of your deck, and the cable cutter and swaging tool, you should not have to purchase any thing else to complete the job.

How many posts do I need?

Because the posts can be spread to a maximum of 6' on center, we will always send enough posts for each kit to where they should never be spread more than 6' apart. For example, both an 8' a 10' and a 12' kit would all come with 3 posts to avoid a post spread of over 6'. But a 14' kit would come with 4 posts.

Can I customize to an exact length like 13' 5"?

Yes, you cut the cable yourself on site to the exact length. Also, the toprail comes in 6' long pieces made from aluminum which cuts easily. For any kit over 6' we include connecting sleeves so you can cut and/or connect the top rail to make an exact length. If you had a 14' section, you would take each 6' piece and cut them to 4'9" and then connect them with the included sleeves to make an exact 14' section. Every middle post will have a top rail connecting sleeve over the post.

How should I order if I live near salt water?

If installing within five miles of saltwater, contact vendor directly for marine grade options. Reach out at 855-GET-CITY or visit www.citypost.com.

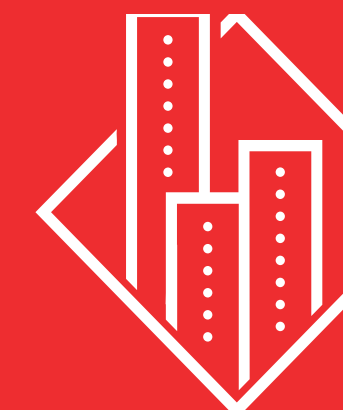

PRODUCT CATALOG

36" Deck Mounted Horizontal Cable Railing

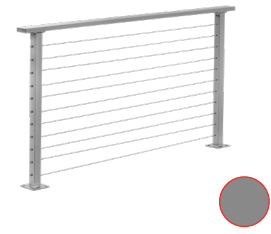
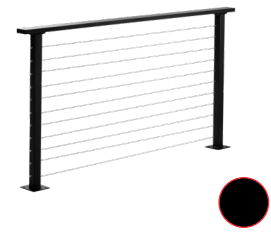

LENGTH (FT)

- 6
- 8
- 10
- 12
- 14
- 16
- 18
- 20
- 22
- 24
- 26
- 28
- 30
- 32
- 34
- 36
- 38
- 40
- 42
- 44
- 46
- 48
- 50
- 52
- 54
- 56
- 58
- 60
- 62
- 64
- 66
- 68
- 70
- 72

BLACK

- CP-6-B-D
- CP-8-B-D
- CP-10-B-D
- CP-12-B-D
- CP-14-B-D
- CP-16-B-D
- CP-18-B-D
- CP-20-B-D
- CP-22-B-D
- CP-24-B-D
- CP-26-B-D
- CP-28-B-D
- CP-30-B-D
- CP-32-B-D
- CP-34-B-D
- CP-36-B-D
- CP-38-B-D
- CP-40-B-D
- CP-42-B-D
- CP-44-B-D
- CP-46-B-D
- CP-48-B-D
- CP-50-B-D
- CP-52-B-D
- CP-54-B-D
- CP-56-B-D
- CP-58-B-D
- CP-60-B-D
- CP-62-B-D
- CP-64-B-D
- CP-66-B-D
- CP-68-B-D
- CP-70-B-D
- CP-72-B-D

BRONZE

- CP-6-BR-D
- CP-8-BR-D
- CP-10-BR-D
- CP-12-BR-D
- CP-14-BR-D
- CP-16-BR-D
- CP-18-BR-D
- CP-20-BR-D
- CP-22-BR-D
- CP-24-BR-D
- CP-26-BR-D
- CP-28-BR-D
- CP-30-BR-D
- CP-32-BR-D
- CP-34-BR-D
- CP-36-BR-D
- CP-38-BR-D
- CP-40-BR-D
- CP-42-BR-D
- CP-44-BR-D
- CP-46-BR-D
- CP-48-BR-D
- CP-50-BR-D
- CP-52-BR-D
- CP-54-BR-D
- CP-56-BR-D
- CP-58-BR-D
- CP-60-BR-D
- CP-62-BR-D
- CP-64-BR-D
- CP-66-BR-D
- CP-68-BR-D
- CP-70-BR-D
- CP-72-BR-D

GREY

- CP-6-G-D
- CP-8-G-D
- CP-10-G-D
- CP-12-G-D
- CP-14-G-D
- CP-16-G-D
- CP-18-G-D
- CP-20-G-D
- CP-22-G-D
- CP-24-G-D
- CP-26-G-D
- CP-28-G-D
- CP-30-G-D
- CP-32-G-D
- CP-34-G-D
- CP-36-G-D
- CP-38-G-D
- CP-40-G-D
- CP-42-G-D
- CP-44-G-D
- CP-46-G-D
- CP-48-G-D
- CP-50-G-D
- CP-52-G-D
- CP-54-G-D
- CP-56-G-D
- CP-58-G-D
- CP-60-G-D
- CP-62-G-D
- CP-64-G-D
- CP-66-G-D
- CP-68-G-D
- CP-70-G-D
- CP-72-B-D

WHITE

- CP-6-W-D
- CP-8-W-D
- CP-10-W-D
- CP-12-W-D
- CP-14-W-D
- CP-16-W-D
- CP-18-W-D
- CP-20-W-D
- CP-22-W-D
- CP-24-W-D
- CP-26-W-D
- CP-28-W-D
- CP-30-W-D
- CP-32-W-D
- CP-34-W-D
- CP-36-W-D
- CP-38-W-D
- CP-40-W-D
- CP-42-W-D
- CP-44-W-D
- CP-46-W-D
- CP-48-W-D
- CP-50-W-D
- CP-52-W-D
- CP-54-W-D
- CP-56-W-D
- CP-58-W-D
- CP-60-W-D
- CP-62-W-D
- CP-64-W-D
- CP-66-W-D
- CP-68-W-D
- CP-70-W-D
- CP-72-W-D



36" Face Mounted Horizontal Cable Railing

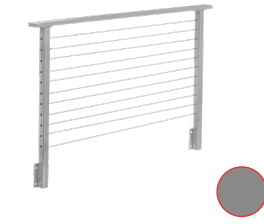

LENGTH (FT)

- 6
- 8
- 10
- 12
- 14
- 16
- 18
- 20
- 22
- 24
- 26
- 28
- 30
- 32
- 34
- 36
- 38
- 40
- 42
- 44
- 46
- 48
- 50
- 52
- 54
- 56
- 58
- 60
- 62
- 64
- 66
- 68
- 70
- 72

BLACK

- CP-6-B-D-F
- CP-8-B-D-F
- CP-10-B-D-F
- CP-12-B-D-F
- CP-14-B-D-F
- CP-16-B-D-F
- CP-18-B-D-F
- CP-20-B-D-F
- CP-22-B-D-F
- CP-24-B-D-F
- CP-26-B-D-F
- CP-28-B-D-F
- CP-30-B-D-F
- CP-32-B-D-F
- CP-34-B-D-F
- CP-36-B-D-F
- CP-38-B-D-F
- CP-40-B-D-F
- CP-42-B-D-F
- CP-44-B-D-F
- CP-46-B-D-F
- CP-48-B-D-F
- CP-50-B-D-F
- CP-52-B-D-F
- CP-54-B-D-F
- CP-56-B-D-F
- CP-58-B-D-F
- CP-60-B-D-F
- CP-62-B-D-F
- CP-64-B-D-F
- CP-66-B-D-F
- CP-68-B-D-F
- CP-70-B-D-F
- CP-72-B-D-F

BRONZE

- CP-6-BR-D-F
- CP-8-BR-D-F
- CP-10-BR-D-F
- CP-12-BR-D-F
- CP-14-BR-D-F
- CP-16-BR-D-F
- CP-18-BR-D-F
- CP-20-BR-D-F
- CP-22-BR-D-F
- CP-24-BR-D-F
- CP-26-BR-D-F
- CP-28-BR-D-F
- CP-30-BR-D-F
- CP-32-BR-D-F
- CP-34-BR-D-F
- CP-36-BR-D-F
- CP-38-BR-D-F
- CP-40-BR-D-F
- CP-42-BR-D-F
- CP-44-BR-D-F
- CP-46-BR-D-F
- CP-48-BR-D-F
- CP-50-BR-D-F
- CP-52-BR-D-F
- CP-54-BR-D-F
- CP-56-BR-D-F
- CP-58-BR-D-F
- CP-60-BR-D-F
- CP-62-BR-D-F
- CP-64-BR-D-F
- CP-66-BR-D-F
- CP-68-BR-D-F
- CP-70-BR-D-F
- CP-72-BR-D-F

GREY

- CP-6-G-D-F
- CP-8-G-D-F
- CP-10-G-D-F
- CP-12-G-D-F
- CP-14-G-D-F
- CP-16-G-D-F
- CP-18-G-D-F
- CP-20-G-D-F
- CP-22-G-D-F
- CP-24-G-D-F
- CP-26-G-D-F
- CP-28-G-D-F
- CP-30-G-D-F
- CP-32-G-D-F
- CP-34-G-D-F
- CP-36-G-D-F
- CP-38-G-D-F
- CP-40-G-D-F
- CP-42-G-D-F
- CP-44-G-D-F
- CP-46-G-D-F
- CP-48-G-D-F
- CP-50-G-D-F
- CP-52-G-D-F
- CP-54-G-D-F
- CP-56-G-D-F
- CP-58-G-D-F
- CP-60-G-D-F
- CP-62-G-D-F
- CP-64-G-D-F
- CP-66-G-D-F
- CP-68-G-D-F
- CP-70-G-D-F
- CP-72-B-D-F

WHITE

- CP-6-W-D-F
- CP-8-W-D-F
- CP-10-W-D-F
- CP-12-W-D-F
- CP-14-W-D-F
- CP-16-W-D-F
- CP-18-W-D-F
- CP-20-W-D-F
- CP-22-W-D-F
- CP-24-W-D-F
- CP-26-W-D-F
- CP-28-W-D-F
- CP-30-W-D-F
- CP-32-W-D-F
- CP-34-W-D-F
- CP-36-W-D-F
- CP-38-W-D-F
- CP-40-W-D-F
- CP-42-W-D-F
- CP-44-W-D-F
- CP-46-W-D-F
- CP-48-W-D-F
- CP-50-W-D-F
- CP-52-W-D-F
- CP-54-W-D-F
- CP-56-W-D-F
- CP-58-W-D-F
- CP-60-W-D-F
- CP-62-W-D-F
- CP-64-W-D-F
- CP-66-W-D-F
- CP-68-W-D-F
- CP-70-W-D-F
- CP-72-W-D-F



42" Deck Mounted Horizontal Cable Railing

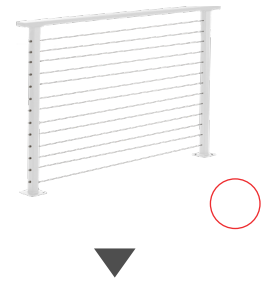
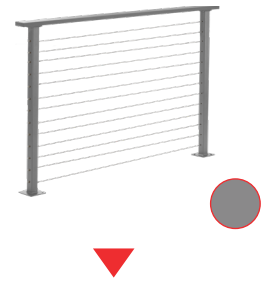

LENGTH (FT)

- 6
- 8
- 10
- 12
- 14
- 16
- 18
- 20
- 22
- 24
- 26
- 28
- 30
- 32
- 34
- 36
- 38
- 40
- 42
- 44
- 46
- 48
- 50
- 52
- 54
- 56
- 58
- 60
- 62
- 64
- 66
- 68
- 70
- 72

BLACK

- CP-6-B-D-42
- CP-8-B-D-42
- CP-10-B-D-42
- CP-12-B-D-42
- CP-14-B-D-42
- CP-16-B-D-42
- CP-18-B-D-42
- CP-20-B-D-42
- CP-22-B-D-42
- CP-24-B-D-42
- CP-26-B-D-42
- CP-28-B-D-42
- CP-30-B-D-42
- CP-32-B-D-42
- CP-34-B-D-42
- CP-36-B-D-42
- CP-38-B-D-42
- CP-40-B-D-42
- CP-42-B-D-42
- CP-44-B-D-42
- CP-46-B-D-42
- CP-48-B-D-42
- CP-50-B-D-42
- CP-52-B-D-42
- CP-54-B-D-42
- CP-56-B-D-42
- CP-58-B-D-42
- CP-60-B-D-42
- CP-62-B-D-42
- CP-64-B-D-42
- CP-66-B-D-42
- CP-68-B-D-42
- CP-70-B-D-42
- CP-72-B-D-42

BRONZE

- CP-6-BR-D-42
- CP-8-BR-D-42
- CP-10-BR-D-42
- CP-12-BR-D-42
- CP-14-BR-D-42
- CP-16-BR-D-42
- CP-18-BR-D-42
- CP-20-BR-D-42
- CP-22-BR-D-42
- CP-24-BR-D-42
- CP-26-BR-D-42
- CP-28-BR-D-42
- CP-30-BR-D-42
- CP-32-BR-D-42
- CP-34-BR-D-42
- CP-36-BR-D-42
- CP-38-BR-D-42
- CP-40-BR-D-42
- CP-42-BR-D-42
- CP-44-BR-D-42
- CP-46-BR-D-42
- CP-48-BR-D-42
- CP-50-BR-D-42
- CP-52-BR-D-42
- CP-54-BR-D-42
- CP-56-BR-D-42
- CP-58-BR-D-42
- CP-60-BR-D-42
- CP-62-BR-D-42
- CP-64-BR-D-42
- CP-66-BR-D-42
- CP-68-BR-D-42
- CP-70-BR-D-42
- CP-72-BR-D-42

GREY

- CP-6-G-D-42
- CP-8-G-D-42
- CP-10-G-D-42
- CP-12-G-D-42
- CP-14-G-D-42
- CP-16-G-D-42
- CP-18-G-D-42
- CP-20-G-D-42
- CP-22-G-D-42
- CP-24-G-D-42
- CP-26-G-D-42
- CP-28-G-D-42
- CP-30-G-D-42
- CP-32-G-D-42
- CP-34-G-D-42
- CP-36-G-D-42
- CP-38-G-D-42
- CP-40-G-D-42
- CP-42-G-D-42
- CP-44-G-D-42
- CP-46-G-D-42
- CP-48-G-D-42
- CP-50-G-D-42
- CP-52-G-D-42
- CP-54-G-D-42
- CP-56-G-D-42
- CP-58-G-D-42
- CP-60-G-D-42
- CP-62-G-D-42
- CP-64-G-D-42
- CP-66-G-D-42
- CP-68-G-D-42
- CP-70-G-D-42
- CP-72-G-D-42

WHITE

- CP-6-W-D-42
- CP-8-W-D-42
- CP-10-W-D-42
- CP-12-W-D-42
- CP-14-W-D-42
- CP-16-W-D-42
- CP-18-W-D-42
- CP-20-W-D-42
- CP-22-W-D-42
- CP-24-W-D-42
- CP-26-W-D-42
- CP-28-W-D-42
- CP-30-W-D-42
- CP-32-W-D-42
- CP-34-W-D-42
- CP-36-W-D-42
- CP-38-W-D-42
- CP-40-W-D-42
- CP-42-W-D-42
- CP-44-W-D-42
- CP-46-W-D-42
- CP-48-W-D-42
- CP-50-W-D-42
- CP-52-W-D-42
- CP-54-W-D-42
- CP-56-W-D-42
- CP-58-W-D-42
- CP-60-W-D-42
- CP-62-W-D-42
- CP-64-W-D-42
- CP-66-W-D-42
- CP-68-W-D-42
- CP-70-W-D-42
- CP-72-W-D-42

42" Face Mounted Horizontal Cable Railing

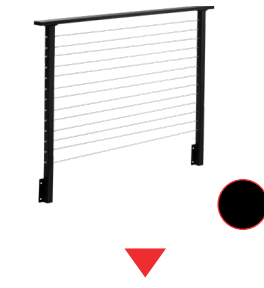

LENGTH (FT)

- 6
- 8
- 10
- 12
- 14
- 16
- 18
- 20
- 22
- 24
- 26
- 28
- 30
- 32
- 34
- 36
- 38
- 40
- 42
- 44
- 46
- 48
- 50
- 52
- 54
- 56
- 58
- 60
- 62
- 64
- 66
- 68
- 70
- 72

BLACK

- CP-6-B-D-F-42
- CP-8-B-D-F-42
- CP-10-B-D-F-42
- CP-12-B-D-F-42
- CP-14-B-D-F-42
- CP-16-B-D-F-42
- CP-18-B-D-F-42
- CP-20-B-D-F-42
- CP-22-B-D-F-42
- CP-24-B-D-F-42
- CP-26-B-D-F-42
- CP-28-B-D-F-42
- CP-30-B-D-F-42
- CP-32-B-D-F-42
- CP-34-B-D-F-42
- CP-36-B-D-F-42
- CP-38-B-D-F-42
- CP-40-B-D-F-42
- CP-42-B-D-F-42
- CP-44-B-D-F-42
- CP-46-B-D-F-42
- CP-48-B-D-F-42
- CP-50-B-D-F-42
- CP-52-B-D-F-42
- CP-54-B-D-F-42
- CP-56-B-D-F-42
- CP-58-B-D-F-42
- CP-60-B-D-F-42
- CP-62-B-D-F-42
- CP-64-B-D-F-42
- CP-66-B-D-F-42
- CP-68-B-D-F-42
- CP-70-B-D-F-42
- CP-72-B-D-F-42

BRONZE

- CP-6-BR-D-F-42
- CP-8-BR-D-F-42
- CP-10-BR-D-F-42
- CP-12-BR-D-F-42
- CP-14-BR-D-F-42
- CP-16-BR-D-F-42
- CP-18-BR-D-F-42
- CP-20-BR-D-F-42
- CP-22-BR-D-F-42
- CP-24-BR-D-F-42
- CP-26-BR-D-F-42
- CP-28-BR-D-F-42
- CP-30-BR-D-F-42
- CP-32-BR-D-F-42
- CP-34-BR-D-F-42
- CP-36-BR-D-F-42
- CP-38-BR-D-F-42
- CP-40-BR-D-F-42
- CP-42-BR-D-F-42
- CP-44-BR-D-F-42
- CP-46-BR-D-F-42
- CP-48-BR-D-F-42
- CP-50-BR-D-F-42
- CP-52-BR-D-F-42
- CP-54-BR-D-F-42
- CP-56-BR-D-F-42
- CP-58-BR-D-F-42
- CP-60-BR-D-F-42
- CP-62-BR-D-F-42
- CP-64-BR-D-F-42
- CP-66-BR-D-F-42
- CP-68-BR-D-F-42
- CP-70-BR-D-F-42
- CP-72-BR-D-F-42

GREY

- CP-6-G-D-F-42
- CP-8-G-D-F-42
- CP-10-G-D-F-42
- CP-12-G-D-F-42
- CP-14-G-D-F-42
- CP-16-G-D-F-42
- CP-18-G-D-F-42
- CP-20-G-D-F-42
- CP-22-G-D-F-42
- CP-24-G-D-F-42
- CP-26-G-D-F-42
- CP-28-G-D-F-42
- CP-30-G-D-F-42
- CP-32-G-D-F-42
- CP-34-G-D-F-42
- CP-36-G-D-F-42
- CP-38-G-D-F-42
- CP-40-G-D-F-42
- CP-42-G-D-F-42
- CP-44-G-D-F-42
- CP-46-G-D-F-42
- CP-48-G-D-F-42
- CP-50-G-D-F-42
- CP-52-G-D-F-42
- CP-54-G-D-F-42
- CP-56-G-D-F-42
- CP-58-G-D-F-42
- CP-60-G-D-F-42
- CP-62-G-D-F-42
- CP-64-G-D-F-42
- CP-66-G-D-F-42
- CP-68-G-D-F-42
- CP-70-G-D-F-42
- CP-72-G-D-F-42

WHITE

- CP-6-W-D-F-42
- CP-8-W-D-F-42
- CP-10-W-D-F-42
- CP-12-W-D-F-42
- CP-14-W-D-F-42
- CP-16-W-D-F-42
- CP-18-W-D-F-42
- CP-20-W-D-F-42
- CP-22-W-D-F-42
- CP-24-W-D-F-42
- CP-26-W-D-F-42
- CP-28-W-D-F-42
- CP-30-W-D-F-42
- CP-32-W-D-F-42
- CP-34-W-D-F-42
- CP-36-W-D-F-42
- CP-38-W-D-F-42
- CP-40-W-D-F-42
- CP-42-W-D-F-42
- CP-44-W-D-F-42
- CP-46-W-D-F-42
- CP-48-W-D-F-42
- CP-50-W-D-F-42
- CP-52-W-D-F-42
- CP-54-W-D-F-42
- CP-56-W-D-F-42
- CP-58-W-D-F-42
- CP-60-W-D-F-42
- CP-62-W-D-F-42
- CP-64-W-D-F-42
- CP-66-W-D-F-42
- CP-68-W-D-F-42
- CP-70-W-D-F-42
- CP-72-W-D-F-42

36" Deck Mounted Stair Cable Railing

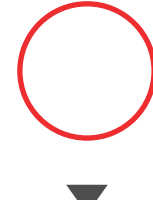
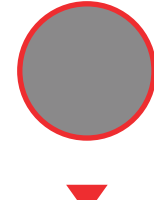
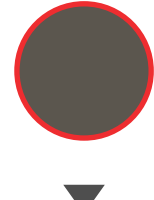
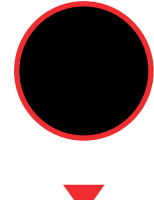
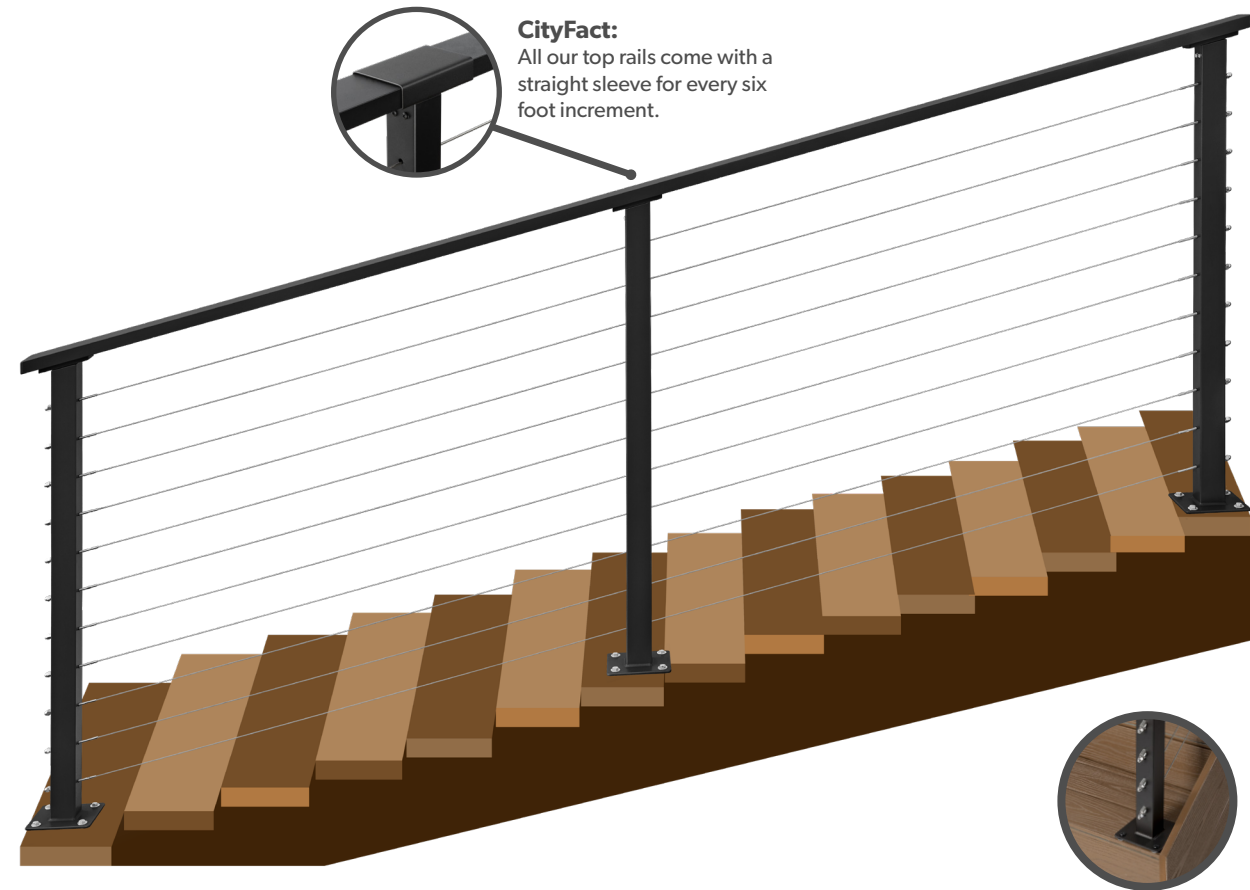

LENGTH (FT)

- 4
- 6
- 8
- 10
- 12
- 14
- 16
- 18
- 20
- 22
- 24
- 26
- 28

BLACK

- CP-4-B-S
- CP-6-B-S
- CP-8-B-S
- CP-10-B-S
- CP-12-B-S
- CP-14-B-S
- CP-16-B-S
- CP-18-B-S
- CP-20-B-S
- CP-22-B-S
- CP-24-B-S
- CP-26-B-S
- CP-28-B-S

BRONZE

- CP-4-BR-S
- CP-6-BR-S
- CP-8-BR-S
- CP-10-BR-S
- CP-12-BR-S
- CP-14-BR-S
- CP-16-BR-S
- CP-18-BR-S
- CP-20-BR-S
- CP-22-BR-S
- CP-24-BR-S
- CP-26-BR-S
- CP-28-BR-S

GREY

- CP-4-G-S
- CP-6-G-S
- CP-8-G-S
- CP-10-G-S
- CP-12-G-S
- CP-14-G-S
- CP-16-G-S
- CP-18-G-S
- CP-20-G-S
- CP-22-G-S
- CP-24-G-S
- CP-26-G-S
- CP-28-G-S

WHITE

- CP-4-W-S
- CP-6-W-S
- CP-8-W-S
- CP-10-W-S
- CP-12-W-S
- CP-14-W-S
- CP-16-W-S
- CP-18-W-S
- CP-20-W-S
- CP-22-W-S
- CP-24-W-S
- CP-26-W-S
- CP-28-W-S



42" Deck Mounted Stair Cable Railing

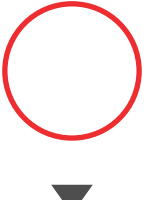
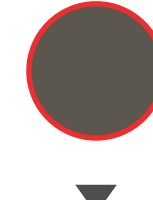
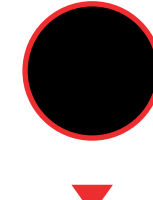
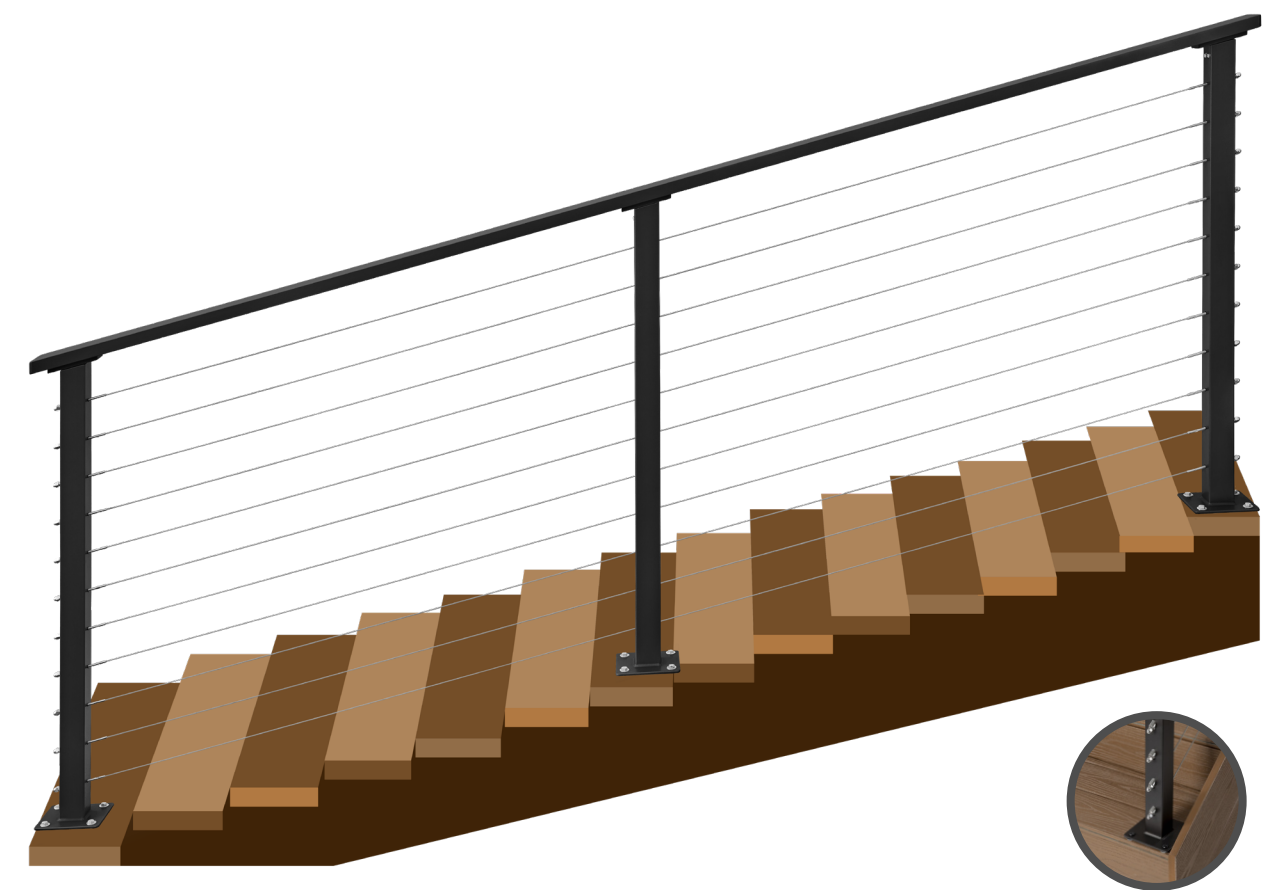

LENGTH (FT)

- 4
- 6
- 8
- 10
- 12
- 14
- 16
- 18
- 20
- 22
- 24
- 26
- 28

BLACK

- CP-4-B-S-42
- CP-6-B-S-42
- CP-8-B-S-42
- CP-10-B-S-42
- CP-12-B-S-42
- CP-14-B-S-42
- CP-16-B-S-42
- CP-18-B-S-42
- CP-20-B-S-42
- CP-22-B-S-42
- CP-24-B-S-42
- CP-26-B-S-42
- CP-28-B-S-42

BRONZE

- CP-4-BR-S-42
- CP-6-BR-S-42
- CP-8-BR-S-42
- CP-10-BR-S-42
- CP-12-BR-S-42
- CP-14-BR-S-42
- CP-16-BR-S-42
- CP-18-BR-S-42
- CP-20-BR-S-42
- CP-22-BR-S-42
- CP-24-BR-S-42
- CP-26-BR-S-42
- CP-28-BR-S-42

GREY

- CP-4-G-S-42
- CP-6-G-S-42
- CP-8-G-S-42
- CP-10-G-S-42
- CP-12-G-S-42
- CP-14-G-S-42
- CP-16-G-S-42
- CP-18-G-S-42
- CP-20-G-S-42
- CP-22-G-S-42
- CP-24-G-S-42
- CP-26-G-S-42
- CP-28-G-S-42

WHITE

- CP-4-W-S-42
- CP-6-W-S-42
- CP-8-W-S-42
- CP-10-W-S-42
- CP-12-W-S-42
- CP-14-W-S-42
- CP-16-W-S-42
- CP-18-W-S-42
- CP-20-W-S-42
- CP-22-W-S-42
- CP-24-W-S-42
- CP-26-W-S-42
- CP-28-W-S-42



36" Face Mounted Stair Cable Railing

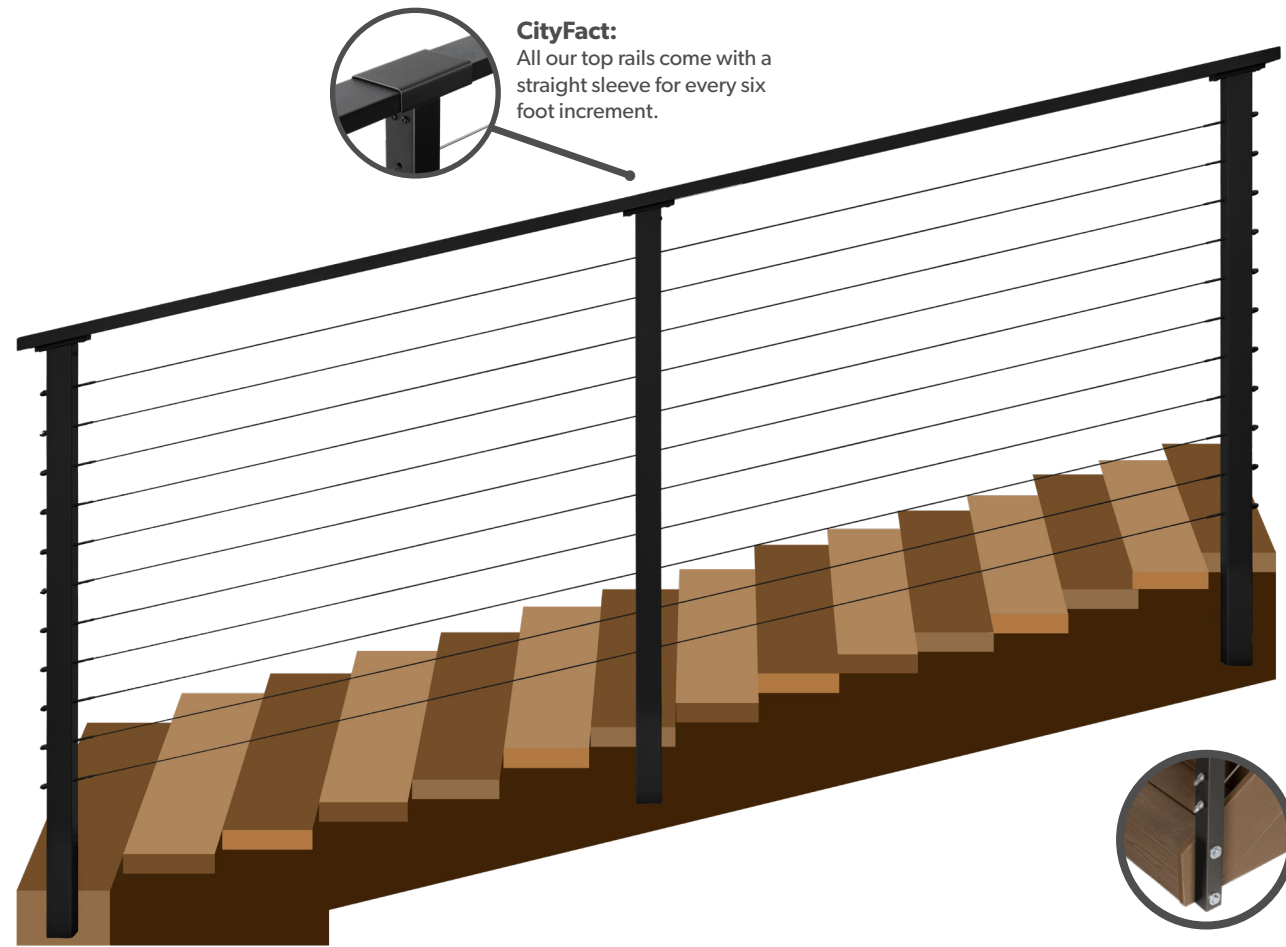

CityFact:
All our top rails come with a straight sleeve for every six foot increment.

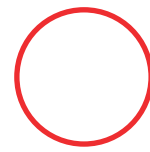
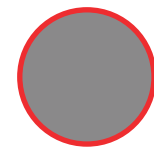
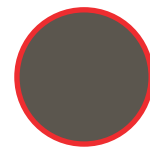
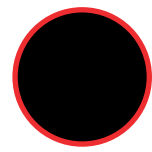

LENGTH (FT)

- 4
- 6
- 8
- 10
- 12
- 14
- 16
- 18
- 20
- 22
- 24
- 26
- 28

BLACK

- CP-4-B-S-F
- CP-6-B-S-F
- CP-8-B-S-F
- CP-10-B-S-F
- CP-12-B-S-F
- CP-14-B-S-F
- CP-16-B-S-F
- CP-18-B-S-F
- CP-20-B-S-F
- CP-22-B-S-F
- CP-24-B-S-F
- CP-26-B-S-F
- CP-28-B-S-F

BRONZE

- CP-4-BR-S-F
- CP-6-BR-S-F
- CP-8-BR-S-F
- CP-10-BR-S-F
- CP-12-BR-S-F
- CP-14-BR-S-F
- CP-16-BR-S-F
- CP-18-BR-S-F
- CP-20-BR-S-F
- CP-22-BR-S-F
- CP-24-BR-S-F
- CP-26-BR-S-F
- CP-28-BR-S-F

GREY

- CP-4-G-S-F
- CP-6-G-S-F
- CP-8-G-S-F
- CP-10-G-S-F
- CP-12-G-S-F
- CP-14-G-S-F
- CP-16-G-S-F
- CP-18-G-S-F
- CP-20-G-S-F
- CP-22-G-S-F
- CP-24-G-S-F
- CP-26-G-S-F
- CP-28-G-S-F

WHITE

- CP-4-W-S-F
- CP-6-W-S-F
- CP-8-W-S-F
- CP-10-W-S-F
- CP-12-W-S-F
- CP-14-W-S-F
- CP-16-W-S-F
- CP-18-W-S-F
- CP-20-W-S-F
- CP-22-W-S-F
- CP-24-W-S-F
- CP-26-W-S-F
- CP-28-W-S-F

42" Face Mounted Stair Cable Railing

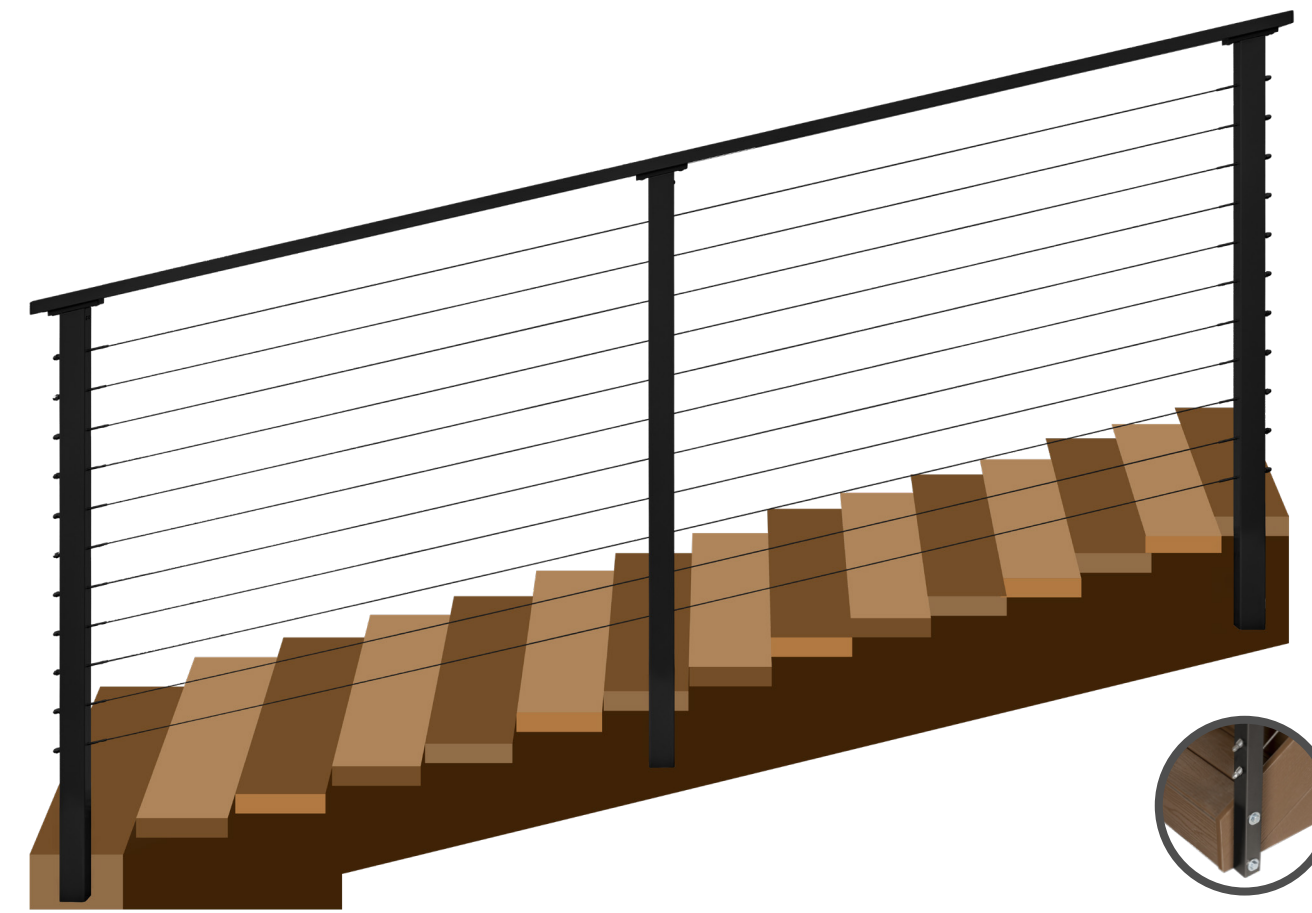

CityFact:
All our top rails come with a straight sleeve for every six foot increment.

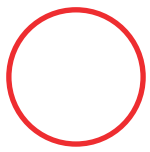
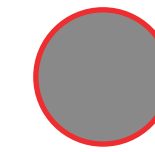
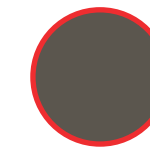
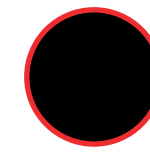

LENGTH (FT)

- 4
- 6
- 8
- 10
- 12
- 14
- 16
- 18
- 20
- 22
- 24
- 26
- 28

BLACK

- CP-4-B-S-F-42
- CP-6-B-S-F-42
- CP-8-B-S-F-42
- CP-10-B-S-F-42
- CP-12-B-S-F-42
- CP-14-B-S-F-42
- CP-16-B-S-F-42
- CP-18-B-S-F-42
- CP-20-B-S-F-42
- CP-22-B-S-F-42
- CP-24-B-S-F-42
- CP-26-B-S-F-42
- CP-28-B-S-F-42

BRONZE

- CP-4-BR-S-F-42
- CP-6-BR-S-F-42
- CP-8-BR-S-F-42
- CP-10-BR-S-F-42
- CP-12-BR-S-F-42
- CP-14-BR-S-F-42
- CP-16-BR-S-F-42
- CP-18-BR-S-F-42
- CP-20-BR-S-F-42
- CP-22-BR-S-F-42
- CP-24-BR-S-F-42
- CP-26-BR-S-F-42
- CP-28-BR-S-F-42

GREY

- CP-4-G-S-F-42
- CP-6-G-S-F-42
- CP-8-G-S-F-42
- CP-10-G-S-F-42
- CP-12-G-S-F-42
- CP-14-G-S-F-42
- CP-16-G-S-F-42
- CP-18-G-S-F-42
- CP-20-G-S-F-42
- CP-22-G-S-F-42
- CP-24-G-S-F-42
- CP-26-G-S-F-42
- CP-28-G-S-F-42

WHITE

- CP-4-W-S-F-42
- CP-6-W-S-F-42
- CP-8-W-S-F-42
- CP-10-W-S-F-42
- CP-12-W-S-F-42
- CP-14-W-S-F-42
- CP-16-W-S-F-42
- CP-18-W-S-F-42
- CP-20-W-S-F-42
- CP-22-W-S-F-42
- CP-24-W-S-F-42
- CP-26-W-S-F-42
- CP-28-W-S-F-42

Railing Connectors (Sleeves)

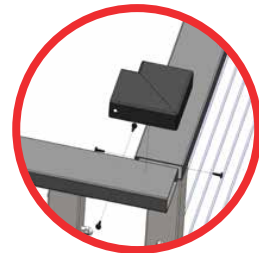

90°

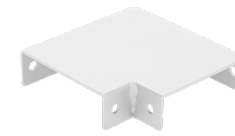
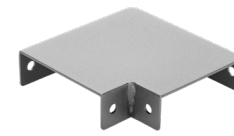
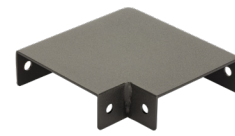

45°

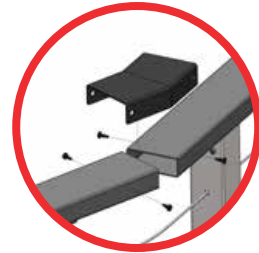
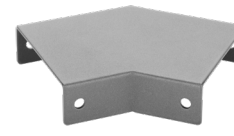
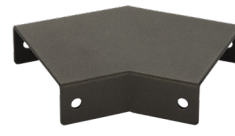

22.5°

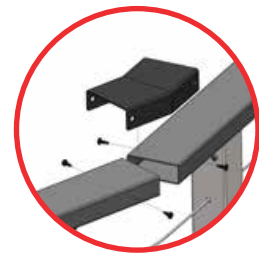
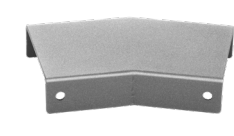

11.25°



SLEEVE ANGLE

- 90 Degree
- 45 Degree
- 22.5 Degree
- 11.25 Degree

BLACK

- CP-SL-90-BL
- CP-SL-45-BL
- CP-SL-22-BL
- CP-SL-11-BL

BRONZE

- CP-SL-90-BR
- CP-SL-45-BR
- CP-SL-22-BR
- CP-SL-11-BR

GREY

- CP-SL-90-GR
- CP-SL-45-GR
- CP-SL-22-GR
- CP-SL-11-GR

WHITE

- CP-SL-90-WH
- CP-SL-45-WH
- CP-SL-22-WH
- CP-SL-11-WH

Other Connectors (Sleeves)



STAIRS 90°

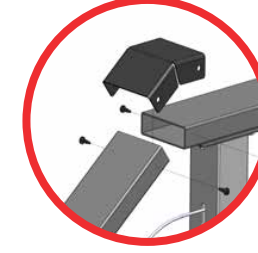
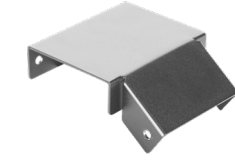
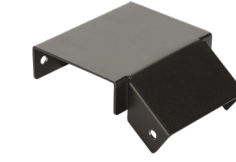

STAIRS UPPER

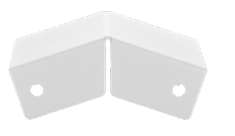
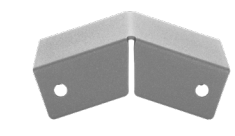
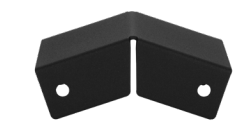

STAIRS LOWER

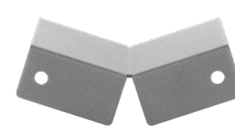
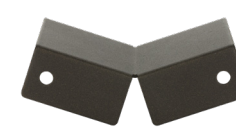

STRAIGHT

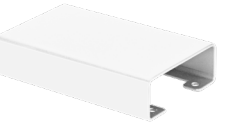
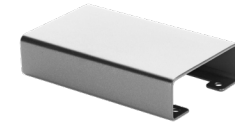
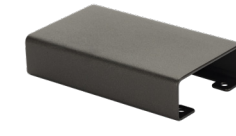
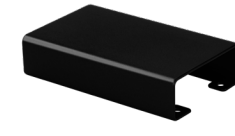

SLEEVE TYPE

- Upper Deck To Stair 90°
- Upper Deck to Stair
- Lower Deck To Stair
- Straight Sleeve

BLACK

- CP-SL-HS90U-BL
- CP-SL-HSU-BL
- CP-SL-HSL-BL
- CP-SL-18-BL

BRONZE

- CP-SL-HS90U-BR
- CP-SL-HSU-BR
- CP-SL-HSL-BR
- CP-SL-18-BR

GREY

- CP-SL-HS90U-GR
- CP-SL-HSU-GR
- CP-SL-HSL-GR
- CP-SL-18-GR

WHITE

- CP-SL-HS90U-WH
- CP-SL-HSU-WH
- CP-SL-HSL-WH
- CP-SL-18-WH

Corner Posts

Base Horizontal Corner

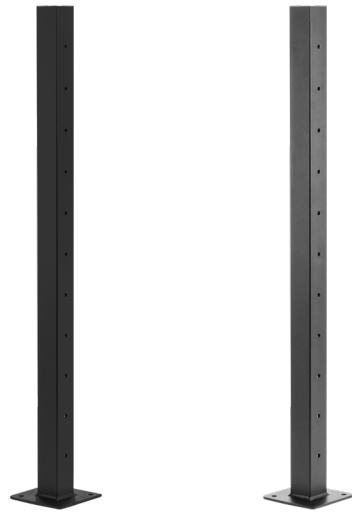

Fascia Horizontal Corner

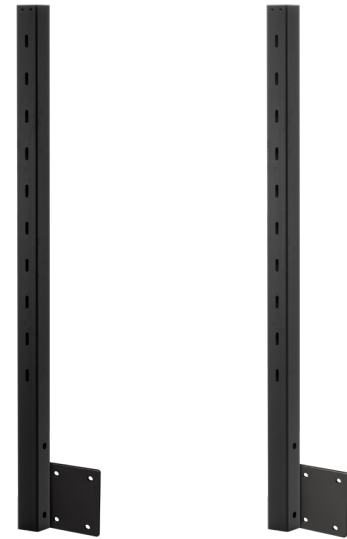

Stair/Horizontal Corner

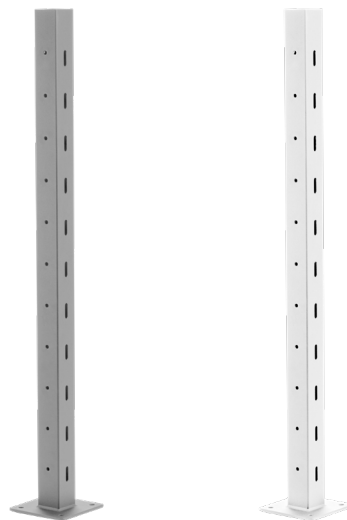
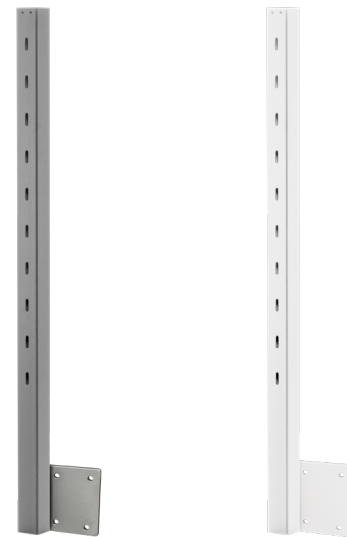
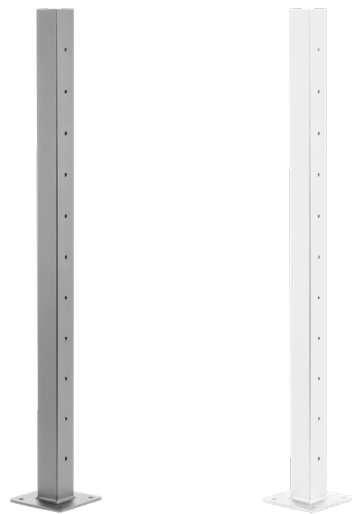
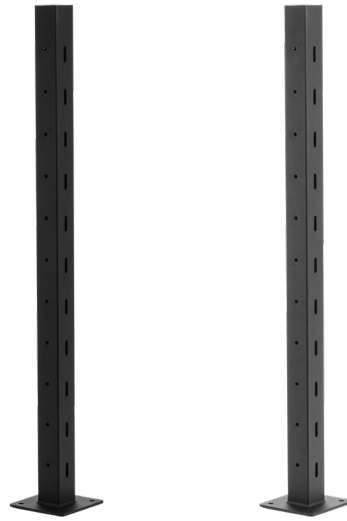

HEIGHT	MOUNTING	DECK TO STAIR
36	Fascia	Horizontal Corner
36	Base	Horizontal Corner
36	Base	Deck to Stair Corner
42	Fascia	Horizontal Corner
42	Base	Horizontal Corner
42	Base	Deck to Stair Corner

BLACK

- CP-HCP-B-36
- CP-HCP-B-36
- CP-DTS-B-36
- CP-HCP-B-42
- CP-HCP-B-42
- CP-DTS-B-42

BRONZE

- CP-HCP-BR-36
- CP-HCP-BR-36
- CP-DTS-BR-36
- CP-HCP-BR-42
- CP-HCP-BR-42
- CP-DTS-BR-42

GREY

- CP-HCP-G-36
- CP-HCP-G-36
- CP-DTS-G-36
- CP-HCP-G-42
- CP-HCP-G-42
- CP-DTS-G-42

WHITE

- CP-HCP-W-36
- CP-HCP-W-36
- CP-DTS-W-36
- CP-HCP-W-42
- CP-HCP-W-42
- CP-DTS-W-42

Corner Posts

HOW CORNERS WORK

Provided you order one kit for each side of your deck, you will have enough posts and hardware to do a standard double corner post. The only item you would need to add is a corner sleeve. If you prefer to use a single post in the corner, add the corresponding item number to the order.

EXAMPLE:
Base Standard Double Post Corner



(Terminated cables)

EXAMPLE:
Fascia Standard Double Post Corner



(Continuous cables)

EXAMPLE:
Standard Double Post Deck to Stair



(Terminated cables)

EXAMPLE:
One Post Base Corner

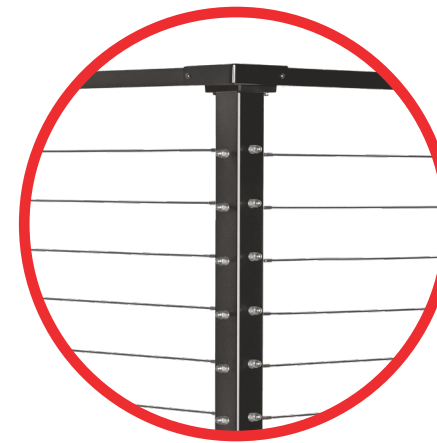

(Terminated cables)

EXAMPLE:
One Post Fascia Corner



(Terminated cables)

EXAMPLE:
One Post Deck to Stair Corner

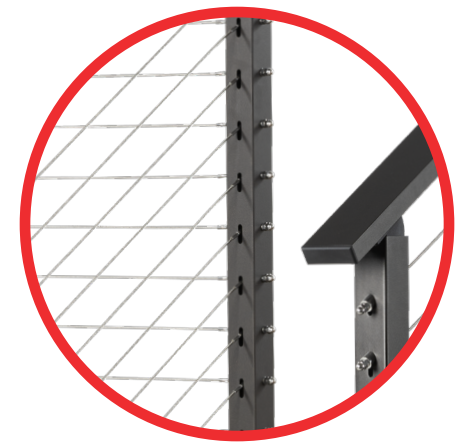

(Terminated cables)

Supporting Parts

TOOLS



Cable Cutter (Item 1/2)
CP-CC&SW



Crimping Tool (Item 2/2)
CP-CC&SW

SLEEVES



1x2 Stair Sleeve
Black: CP-HS90U2-BL
Grey: CP-HS90U2-GR
Bronze: CP-HS90U2-BR
White: CP-HS90U2-WH

Assembly Drawings

Base Mount Horizontal 6' Or Less

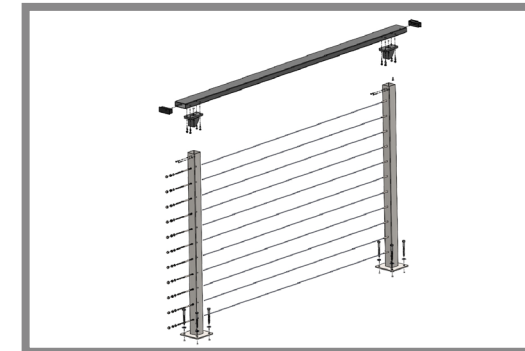

Base Mount Horizontal 6' - 12'

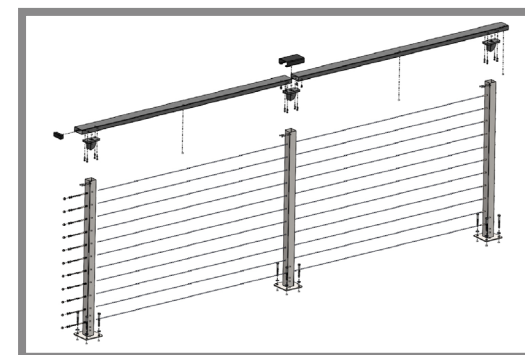

Base Mount Horizontal Over 12'

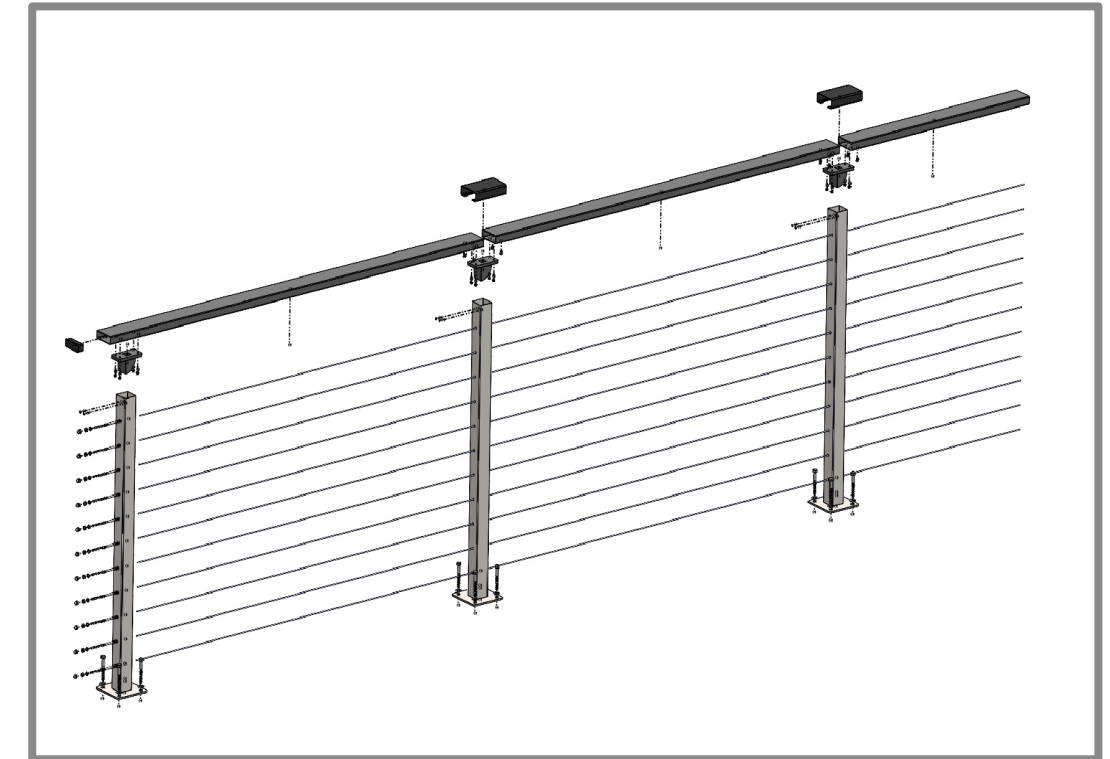

Fascia Mount Horizontal 6' Or Less

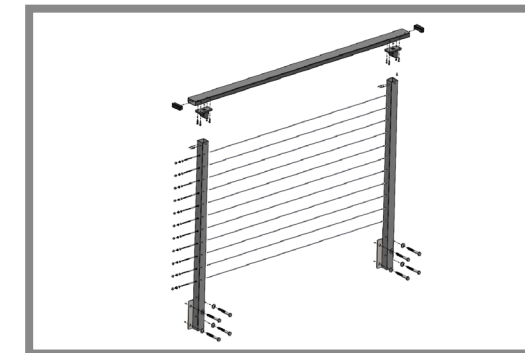

Fascia Mount Horizontal 6' - 12'

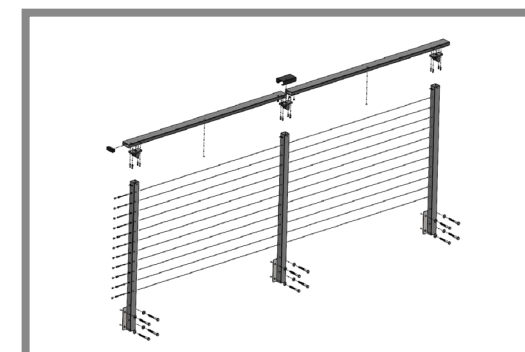

Fascia Mount Horizontal Over 12'

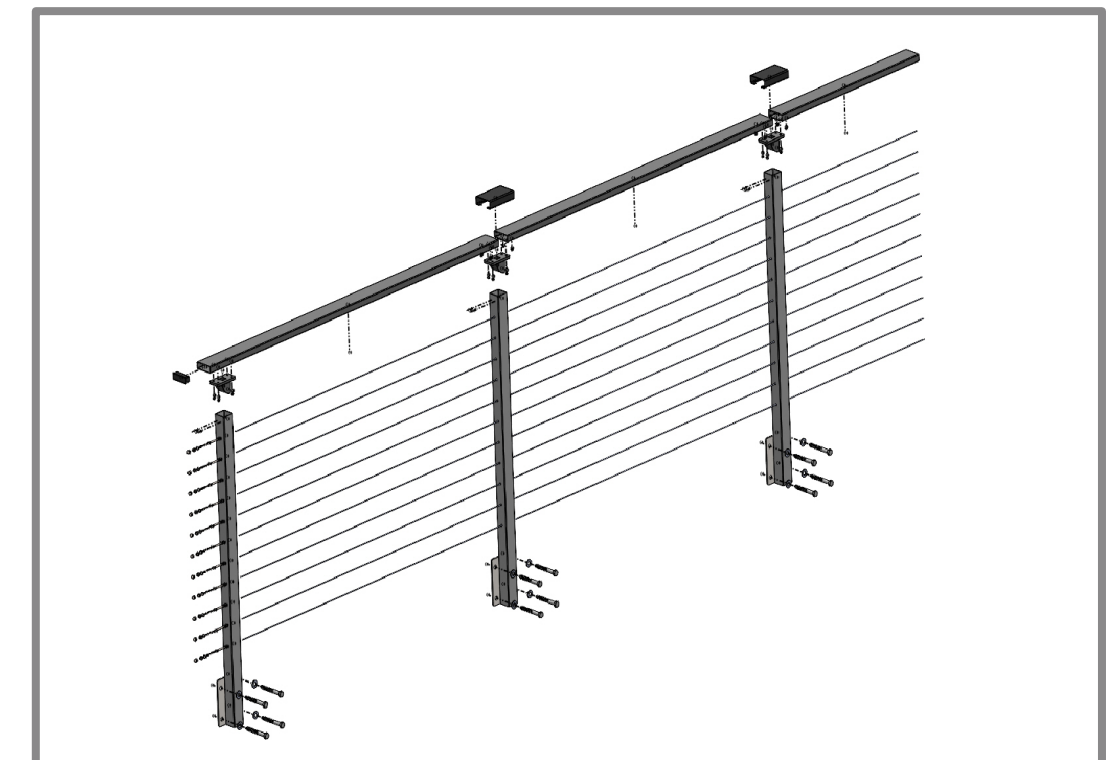

Assembly Drawings

Base Mount Stairs 6' Or Less

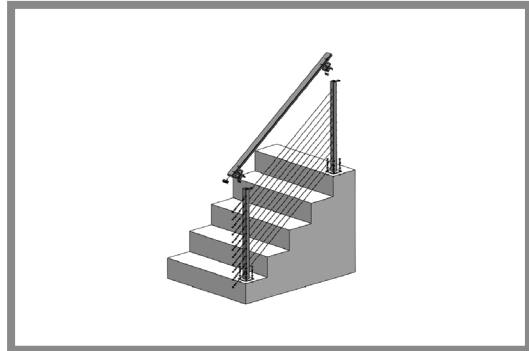

Base Mount Stairs 6'-12'

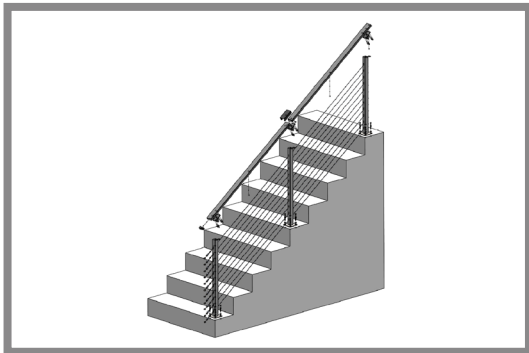

Base Mount Stairs Over 12'

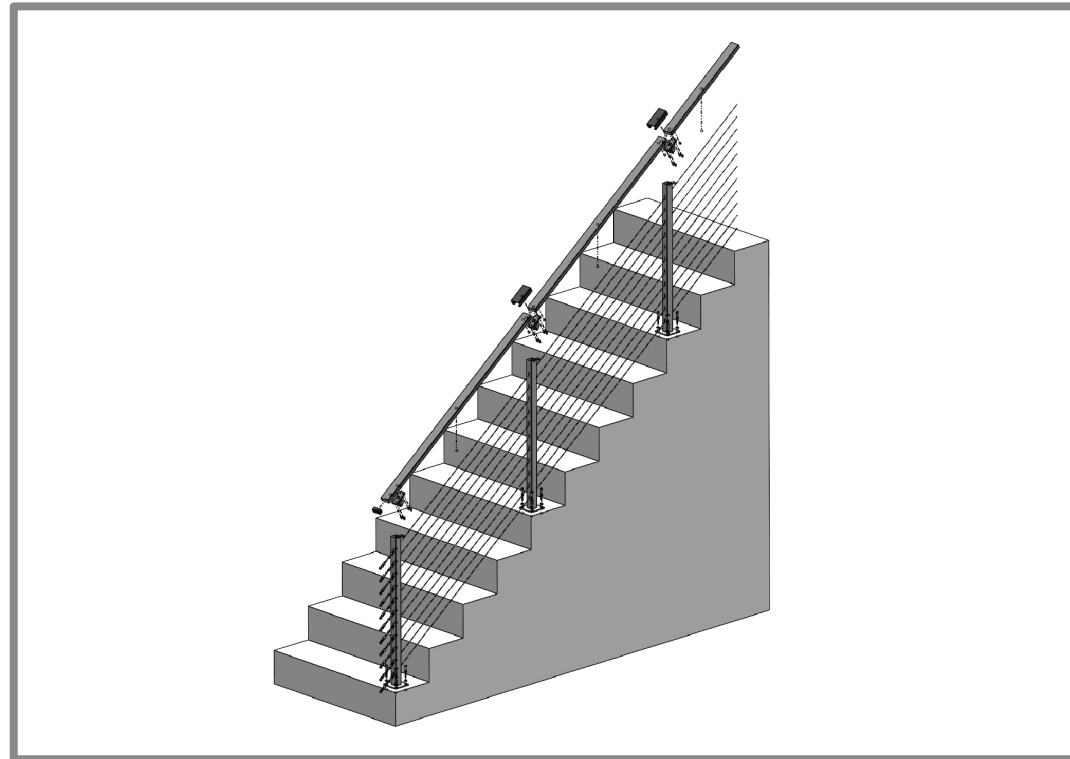

Fascia Mount Stairs 6' Or Less

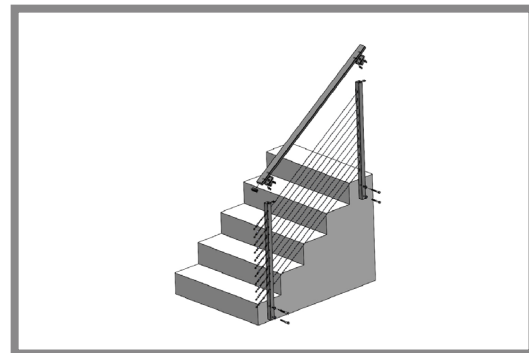

Fascia Mount Stairs 6'-12'

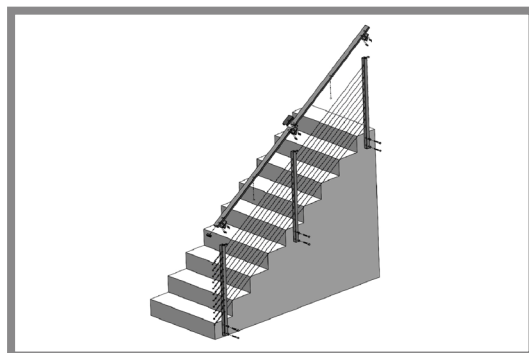

Fascia Mount Stairs Over 12'

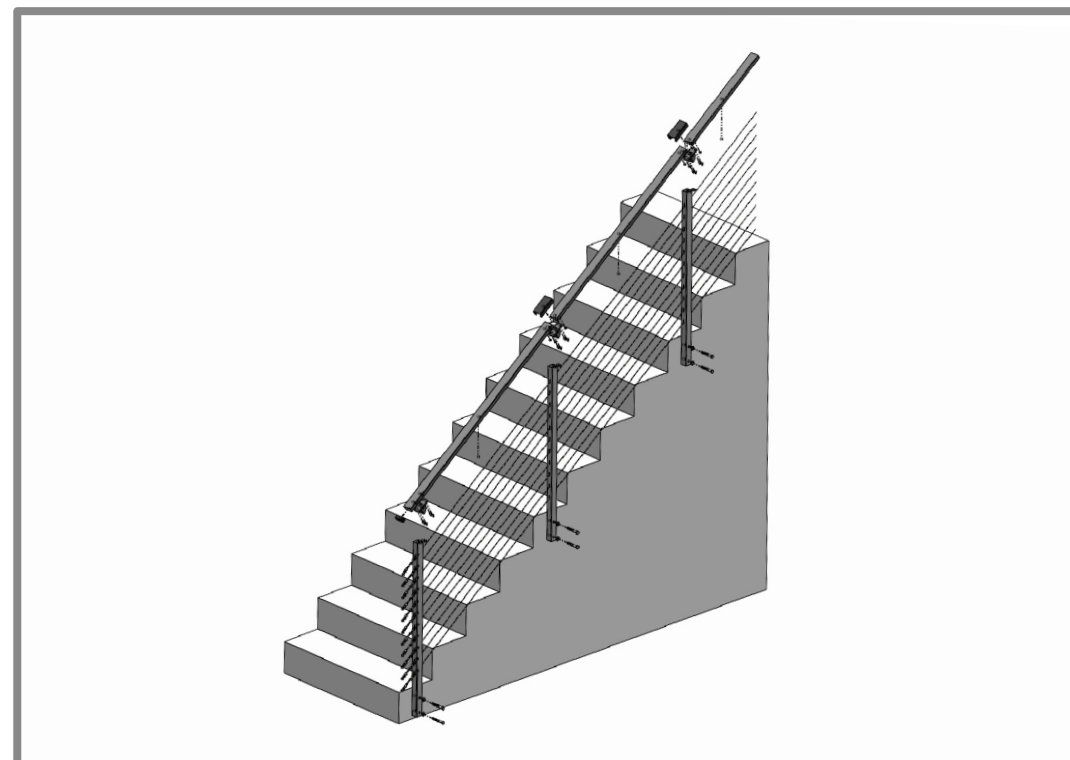

Guides

Click Links Below for Installation Guides

- **Order of Operations for a successful CityPost Installation**
- **Full install tutorial**
- **Cutting Aluminum Top Rail**
- **Securing Toprail to the Posts**
- **Transitions**
- **End Cap Installation**
- **Running Cable**
- **How to tension cables**



HAVE A QUESTION?

CALL US AT **855-GET-CITY** OR SEND US AN EMAIL AT **ORDERS@CITYPOST.COM**