



Item # 1000 026 321

Model #HD32448RCPS

USE AND CARE GUIDE

6-SHELF STORAGE RACK

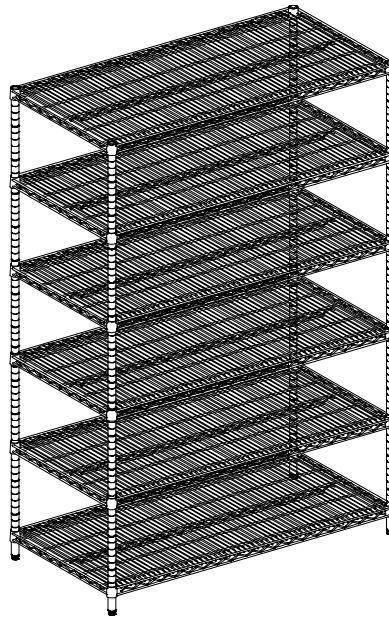

Questions, problems, missing parts? Before returning to the store,
call Customer Service

8 a.m. - 6 p.m., EST, Monday-Thursday

8 a.m. - 5 p.m., EST, Friday

888-449-5520

HOMEDEPOT.COM/HDX

THANK YOU

We appreciate the trust and confidence you have placed in HDX through the purchase of this storage unit. We strive to continually create quality products designed to enhance your home. Visit us online to see our full line of products available for your home improvement needs. Thank you for choosing HDX!

Table of Contents

Table of Contents	2	Specifications	2
Safety Information.....	2	Package Contents.....	3
Warranty	2	Assembly	4
Pre-Assembly	2		
Planning Assembly.....	2		

Safety Information

 **WARNING:** Do not exceed the maximum weight limit of 850 lbs. per shelf, evenly distributed.

 **CAUTION:** Do not allow children to climb or play in or around the shelves.

 **CAUTION:** Evenly distribute the weight across each shelf, and keep the heavier loads on the bottom.

 **CAUTION:** Place the unit on a level surface to avoid a tipping hazard.

Warranty

If this product is defective, contact the customer service team at 888-449-5520 or visit www.HOMEDEPOT.COM/HDX.

Pre-Assembly

PLANNING ASSEMBLY

Carefully read all instructions and caution warnings before beginning assembly. Determine shelving heights prior to assembly to avoid dismantling for adjustment. More than one person may be required during assembly. Use care when handling. Assemble the unit on a soft surface, such as carpet, to avoid scratching the floor or the unit.

 **CAUTION:** Place the unit on a level surface to avoid a tipping hazard.

 **NOTE:** Please dispose of the loose, round plastic pieces. These are used to separate the shelves for shipping purposes.



SPECIFICATIONS

Weight	103.7 lbs.
Width	47.75 in.
Depth	24 in.
Height	72 in.

Pre-Assembly (continued)

PACKAGE CONTENTS

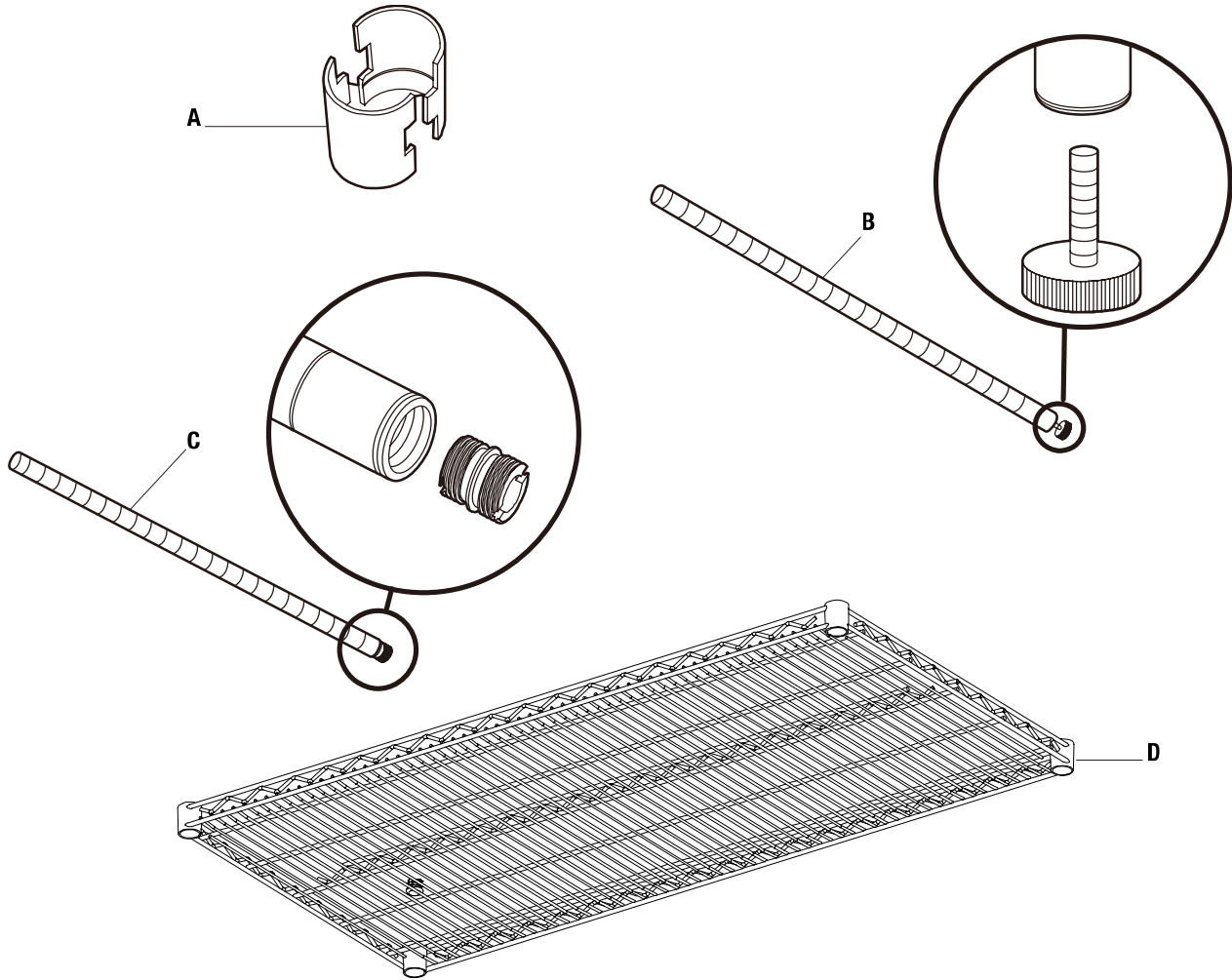

Part	Description	Quantity
A	Plastic Sleeve	50 (2 spare parts)
B	Bottom Post Assembly	4
C	Top Post Assembly	4
D	Shelf	6

Assembly

1 Assembling the posts

- Screw the top post assembly (C) into the bottom post assembly (B) until secure.
- Repeat this procedure for the remaining posts (B & C).

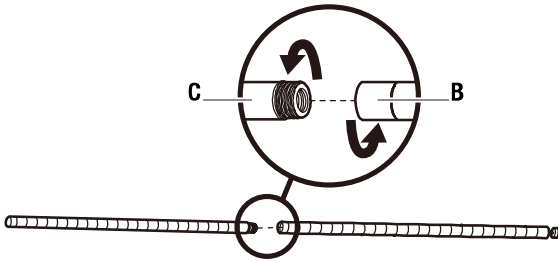

3 Attaching additional shelves

- Locate the desired position of the next lowest shelf (D), and insert the plastic sleeves (A) into the appropriate grooves on the post assemblies.
- Slide the shelf (D) down from the top of the post assemblies and onto the plastic sleeves (A). Push down on each shelf (D) corner, ensuring that it is firmly seated on the plastic sleeves (A).
- Repeat this procedure for the remaining shelves (D).

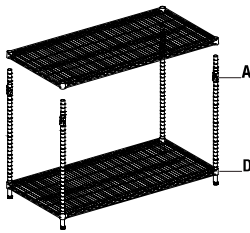

4 Leveling the unit



NOTE: The bottom post assemblies (B) have foot levelers pre-installed into the bottoms.

- Screw the pre-installed foot levelers clockwise or Counter clockwise until the unit is level.

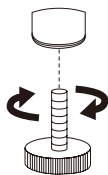

2 Attaching the bottom shelf



NOTE: More than one person may be required for this step.

- Locate the desired position where the lowest shelf will be installed onto the post assemblies.
- Insert a plastic sleeve (A) into the appropriate groove on each bottom post assembly (B). Ensure the tapered end of the plastic sleeve (A) is facing up towards the top post (C).
- Place the shelf (D) on its side, and slide the post assemblies up through the bottom of the shelf (D), beginning with the top post (C), until the shelf (D) is firmly seated on the plastic sleeves (A).
- After the shelf (D) is in place, turn the unit to the upright position.
- Push down on each corner of the shelf (D), ensuring it is in the fully locked position.

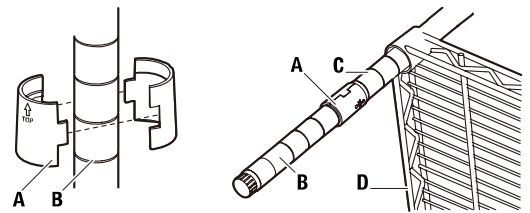

NOTE: The tapered sleeves must be at the same height for each pole to ensure the shelf sits on the sleeves levelly.

NOTE: The post has a groove with a double line marking. It can help to identify the height of the tapered sleeve in each post.

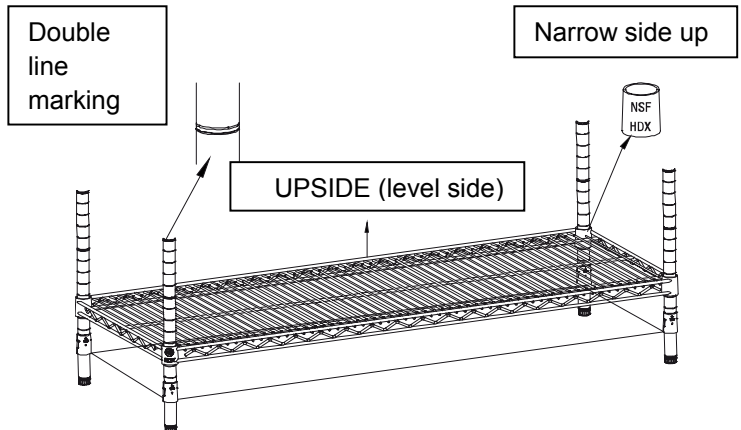



Núm. de artículo 1000 026 321

Núm. de modelo HD32448RCPS

GUÍA DE USO Y CUIDADO

ESTANTE DE ALMACENAMIENTO DE 6 REPISAS

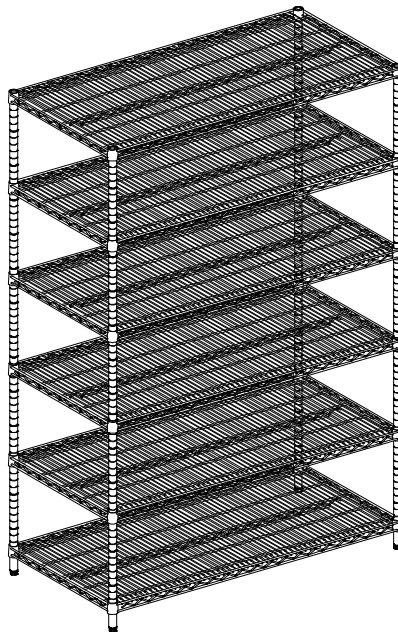

¿Tiene preguntas, problemas, o faltan piezas? Antes de regresar a la tienda,
llame a Servicio al Cliente
de lunes a jueves de 8 a.m. a 6 p.m., hora local del Este

viernes de 8 a.m. a 5 p.m., hora local del Este

888-449-5520

HOMEDEPOT.COM/HDX

GRACIAS

Apreciamos la confianza que ha depositado en HDX por la compra de esta unidad de almacenamientos. Nos esforzamos por crear continuamente productos de calidad diseñados para mejorar su hogar. Visítenos en Internet para ver nuestra línea completa de productos disponibles para sus necesidades de mejorar su hogar. ¡Gracias por elegir a HDX !

Índice

Índice	2	Especificaciones	2
Información de seguridad	2	Contenido del paquete	3
Garantía	2	Ensamblaje	4
Pre-ensamblaje	2		
Planificación del ensamblaje	2		

Información de seguridad



ADVERTENCIA: No supere el peso máximo del producto de 850lbs. por repisa, uniformemente distribuido.



PRECAUCIÓN: No permita que los niños escalen o jueguen en o cerca de las repisas.



PRECAUCIÓN: Distribuya uniformemente el peso a través de cada repisa, y mantenga las cargas más pesadas en el fondo.



PRECAUCIÓN: Coloque la unidad en una superficie a nivel para evitar el riesgo de volcaduras.

Garantía

Si este producto está defectuoso, póngase en contacto con el equipo de Servicio al Cliente llamando al 888-449-5520 o visite www.HOMEDEPOT.COM/HDX.

Pre-ensamblaje

PLANNIFICACIÓN DEL ENSAMBLAJE

Lea con cuidado todas las instrucciones y las advertencias de precaución antes de ensamblar. Determine las alturas de las repisas antes de ensamblar para evitar tener que desmantelar para hacer ajustes. Puede que se necesite más de una persona durante el ensamblaje. Tenga cuidado cuando la manipule. Para evitar rayar el piso o la unidad, ensamble la unidad sobre una superficie suave, como una alfombra.



PRECAUCIÓN: Coloque la unidad en una superficie a nivel para evitar el riesgo de volcaduras.



NOTA: Deshágase de las piezas plásticas redondas sueltas. Estas son usadas para separar las repisas para fines de envío.



ESPECIFICACIONES

Peso	103.7 lbs.
Anchura	47.75 plg.
Profundidad	24 plg.
Altura	72 plg.

HARDWARE CONTENTS

AA

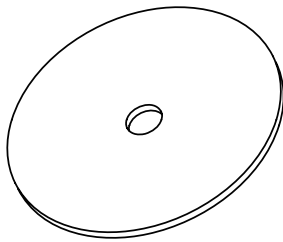

Washer
Qty. 2

BB

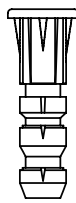

Plastic Anchor
Qty. 2

CC

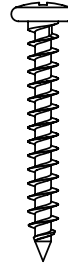

Screw
Qty. 2

To prevent the unit from tipping over, secure it to a wall in the following manner: Drill a hole in the wall using a 1/4 in. drill bit (not included). Insert the plastic anchor (BB) into the hole. Insert the screw (CC) through the washer (AA) then through the back of the top shelf wire and into the plastic anchor (BB) as shown. Be sure unit is secure and doesn't wobble or tip over.

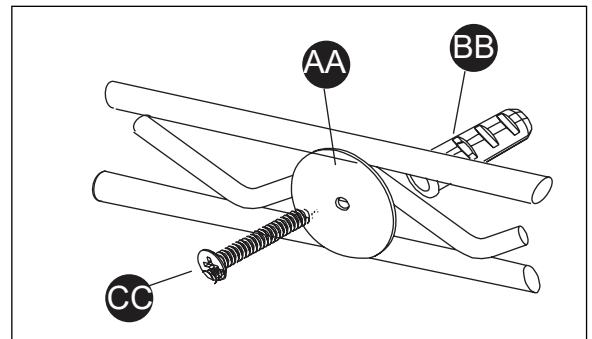

⚠ WARNING

- Unit must be placed on a level surface or leveled with included hardware (when applicable).
- Do not sit or stand on or allow children to climb, sit or stand on the assembled product.
- For safety reasons, it is imperative that this unit be mounted on the wall or floor.
- Unit can tip over causing severe injury or death.
- Do not exceed the recommended weight limits.
- Evenly distribute the weight on each level and always keep the heavier loads on the bottom.
- Before cutting, drilling or hammering into any wall or floor surface, verify the location of electrical, plumbing and gas lines. Cutting may cause serious injury.

HDX™

Questions, problems, missing parts?

Before returning to the store call
Customer Service

8 a.m. - 6 p.m., EST, Monday-Thursday

8 a.m. - 5 p.m., EST, Friday

888-449-5520

WWW.HOMEDEPOT.COM

Retain this manual for future use.

ADITAMENTOS

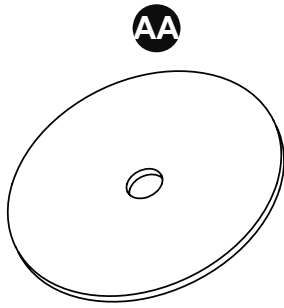

Arandela
Cant. 2

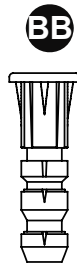

Ancla de expansión de plástico
Cant. 2



Tornillo
Cant. 2

Para evitar que la unidad se vuelque, fijela a la pared de la siguiente manera: Taladre un orificio en la pared con una broca para taladro de 1/4" (no se incluye). Inserte el ancla de expansión de plástico (BB) en el orificio. Inserte el tornillo (CC) a través de la arandela (AA) y luego por la parte posterior de los alambres de la repisa superior y en el ancla de expansión de plástico (BB), como se muestra. Asegúrese de que la unidad esté fija y que no tambalee ni se vuelque.

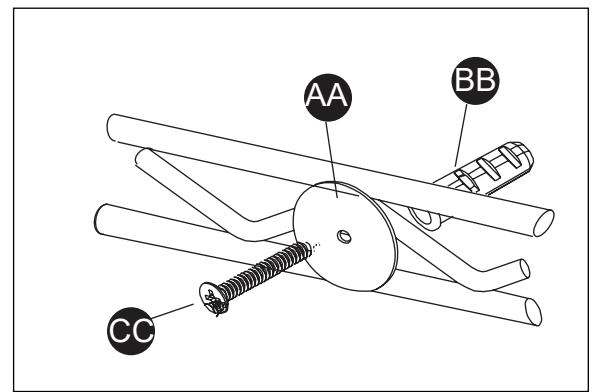

⚠ ADVERTENCIA

- El producto debe colocarse en una superficie nivelada, o nivelarse con el herraje incluido (si aplica).
- No sienta, pare o permita que los niños suban, se sienten o se paren en el producto ensamblado.
- Por razones de seguridad, es indispensable que el producto quede fijo en la pared.
- El producto se puede volcar causando lesiones graves o la muerte.
- No rebasar el límite de peso recomendado.
- Distribuir la carga uniformemente en cada nivel y mantener siempre lo más pesado en la parte inferior.
- Antes de cortar, perforar o martillar en la pared o piso, verificar la ubicación de la instalación eléctrica, tuberías y líneas de gas; cortarlas puede causar graves lesiones.

HDX™

¿Tiene preguntas, problemas, o faltan piezas?

Antes de regresar a la tienda,

llame a Servicio al Cliente de HDX

de lunes a viernes de 8 a.m. a 6 p.m., hora local del Este

8 a.m. a 5 p.m., hora del este, Viernes

888-449-5520

WWW.HOMEDEPOT.COM

Conserve este manual para uso futuro.